

Transmits Input Device ON/OFF Signals and Power.
The Key to Effortless Wiring for Rotating and Moving Bodies.



 Be sure to read *Safety Precautions* on page 5.

Features

Transmit Multiple Switch Signals and Power to without Contact

By connecting the B7AP Power Coupler between the B7A Input Unit and B7A Output Unit, it is possible to transmit multiple switch signals without contact from input devices to controllers. When using the B7AP Power Coupler in this way, it is possible to transmit power via electromagnetic coupling, so a power supply for the Input Unit is not necessary.

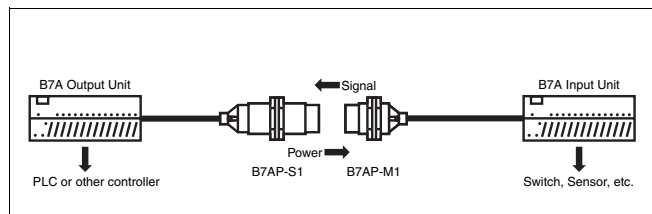

Equipped with a Verification LED for Easy Settings

The B7AP-M1 is equipped with an operation indicator that lights the usable range during Coupler setup, allowing for easy setup.

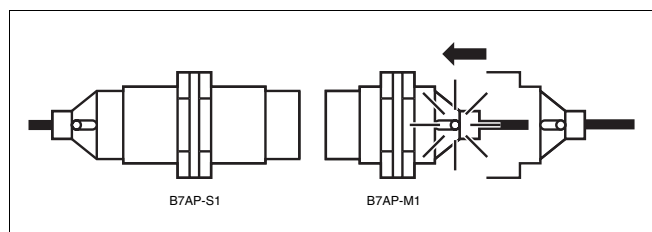

Total Transmission Distance Up to 100 m

The transmission distance between Power Couplers without contact is 8 ± 1.5 mm. The maximum transmission distance between the B7A Input Unit and B7A Output Unit is 100 m (when transmitting power or signals).

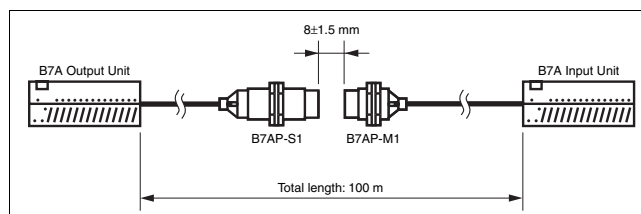

Transmission Also Possible When Separated by a Non-metallic Object

Switch signals and power can be transmitted even when there is plastic, glass, wooden, or other non-metallic objects between the Couplers (B7AP-S1/-M1).

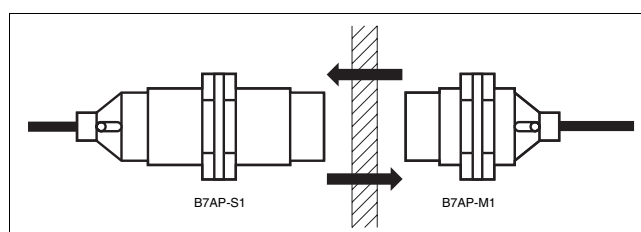

Usable in a Variety of Environments with IP67 Environmental Resistance

The Couplers have IP67 degree of protection, which allows them to be used in harsh environments that may expose them to dust from glass, plastic or paper, or exposure to water. The Couplers can be used in a wide range of applications.

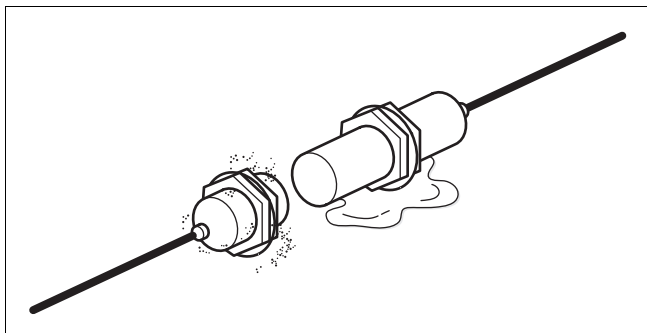

Select Transmission Method Based on Application Conditions

When transmitting power and transmission signals, a maximum of 10 points can be input simultaneously to the B7A Input Unit.

(B7A Input Unit: Input Current 3.8 mA × 10 points = 38 mA)

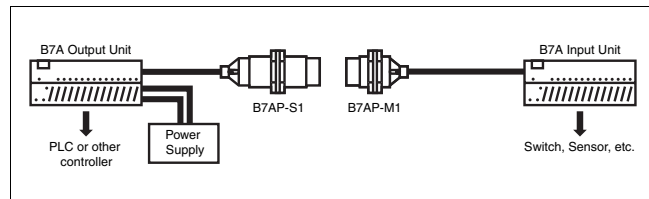

When transmitting only signals, a maximum of 16 points can be input to the B7A Input Unit.

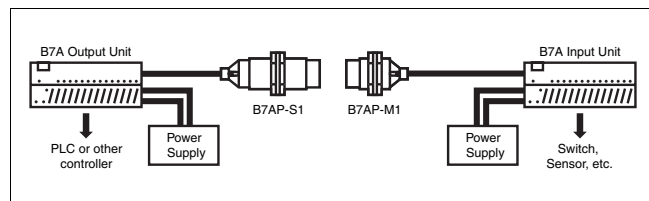

Applications

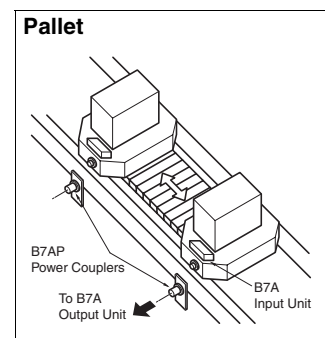
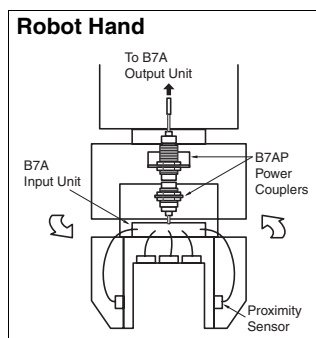
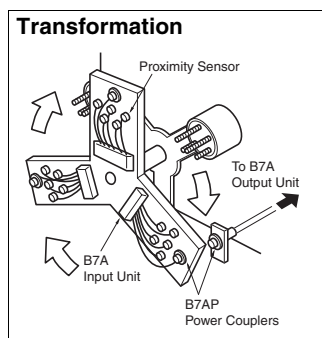
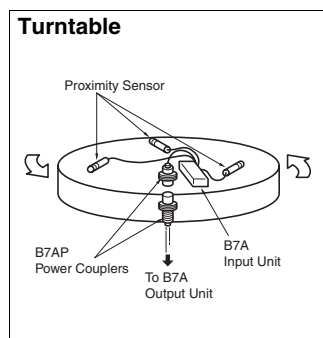

Ordering Information

Classification	Appearance	Transmission distance (couplers)	I/O transmission delay time	Model
Stationary Unit	M30 	 8±1.5 mm Stationary Unit Moving Unit	Typical: 19.2 ms Max: 31 ms	B7AP-S1 *
Moving Unit	M30 			B7AP-M1

* The B7AP-S1 Power Coupler has a gauge that is used to adjust the transmission distance between the B7AP Power Couplers.

Ratings and Specifications

Stationary Unit Transmission Specifications

Item	Model	B7AP-S1
Transmission method		Unidirectional, time-division multiplex
Transmission distance	Between Couplers	Between B7AP-S1 and -M1: 8±1.5 mm
	Between Input Unit and Output Unit	Between B7A Input and Output Units: 100 m max. *1
Transmission delay time		Standard: 19.2 ms, Maximum: 31 ms
Minimum Coupler interfacing time		0.3 s *2
Minimum distance between Power Couplers mounted in parallel		60 mm min.

*1. The value is for when a power supply is provided only for the B7AP-S1.

*2. Minimum Coupler interfacing time is the minimum time required for signal and power transmission between the Power Couplers.

Engineering Data (Typical)

Transmission Range

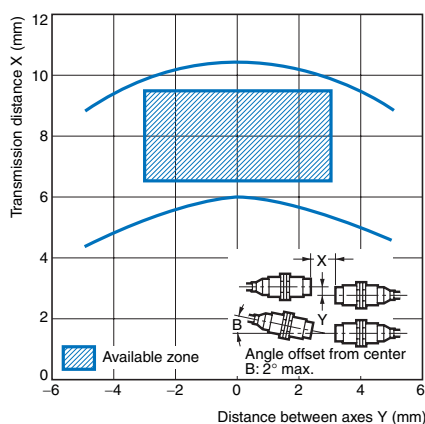

Moving Unit Specifications

Item	Model	B7AP-M1
Power supply		12 VDC±10%, 38 mA

Note: Use the Moving Unit so that the total current consumption of all input devices is 38 mA max.

Specifications

Item	Model	B7AP-S1	B7AP-M1
Power supply voltage (operating voltage range)		24 VDC ±10, ripple (p-p): 10% max	---
Current consumption		300 mA	---
Insulation resistance		100 MΩ min. (at 500 VDC) between each lead wire and external parts	
Dielectric strength		1,000 VAC, 50/60 Hz for 1 min between each lead wire and external parts	
Noise immunity		Noise level: ±1.5 kV, pulse width: 100 ns/1 μs	
Ambient temperature		Operating: -10 to 55°C Storage: -25 to 65°C (with no icing or condensation)	
Ambient humidity		Operating/Storage: 35% to 95% (with no condensation)	
Vibration resistance (destruction)		10 to 55 Hz, 1.5-mm double amplitude each in X, Y, and Z directions	
Shock resistance (destruction)		500 m/s ² each in X, Y, and Z directions	
Degree of protection		IEC IP67	
Nut tightening strength		39 N·m	
Connection method		Pre-wired Models (Standard cable length: 2 m)	
		Cable tensile strength: 49 N	
Weight (packed state)		Approx. 300 g	Approx. 230 g

Contact your OMRON sales representative for further information.

Connectable B7A Models (The 10-point and 16-point High-speed B7A Models cannot be connected.)

B7AP Model	Applicable B7A Link Terminal	Max. I/O points (*1)	Applicable input device (*3)
B7AP-S1	B7A-R6B31	(*2)	---
	B7A-R6C31		
	B7A-R6F31		
	B7A-R6G31		
	B7A-R6A52		
	B7A-R6A33		
	B7A-R3A33		
	B7A-R3A33-M		
	B7AS-R6B31		
	B7AM-6BS		
	G70D-R6□□1-B7A		
	B7AH-R6D53		
B7AP-M1	B7A-T6□1	10 (16)	Two-wire sensor, contact
	B7A-T6D2	10 (16)	Contact
	B7A-T6E3	10 (16)	
	B7A-T3E3	10 (16)	
	B7A-T3E3-M	10 (16)	
	B7AS-T6B1	10 (16)	Two-wire sensor, contact
	B7AM-6BS	10 (16)	
	B7AH-T6D3	16	CMOS input is supported

*1. The maximum I/O points refers to the maximum I/O points handled simultaneously by the B7A Input and Output Units. Figures in parentheses indicate the maximum I/O points handled simultaneously by the B7A Input and Output Units each connected with an independent power supply. Refer to the *Power Supplies* page.

The B7AH requires two types of power supplies (24 VDC and 5 VDC), so a power supply is required for each Unit.

*2. The maximum I/O points are the same as the maximum input points of the B7A Input Unit connected to the B7AP-M1.

*3. PLCs and three-wire sensors can be connected only if the B7A Input and Output Units are each connected with independent power supplies. Refer to the section on *Power Supplies*.

Connection

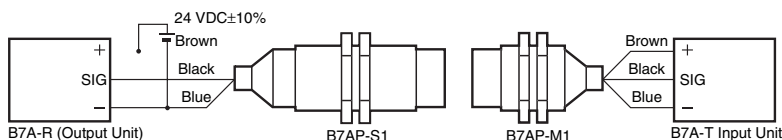

Power Supplies

• Signal and Power Transmission (with Power Supplied to B7AP-S1)

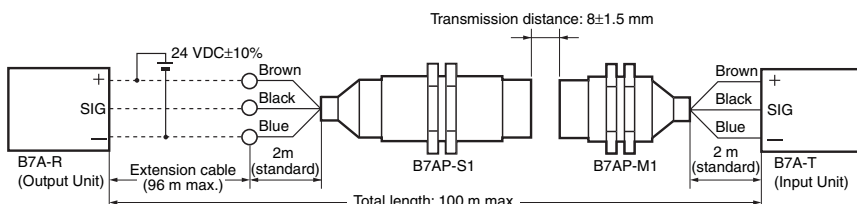

- Note 1. The thickness of the extension cable for the B7AP-S1 Power Coupler must be 0.75 mm² min.
2. No extension cable can be connected to the B7AP-M1 Power Coupler. Use the original 2-m cable connected to the B7AP-M1 Power Coupler.
3. Refer to page 3, B7A Models for the maximum input points of the B7A Input Unit.
4. No PLC or three-wire sensor can be connected to the B7A Input Unit.

• Signal Transmission Only (with Power Supplied to B7AP-S1 and B7AP-M1)

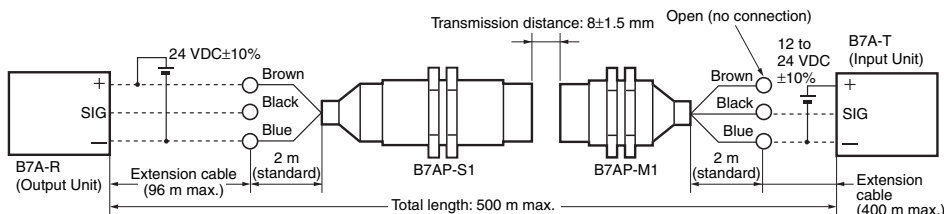

- Note 1. The thickness of the extension cable for the B7AP-S1 or B7AP-M1 Power Coupler must be 0.75 mm² min.
2. For transmitting signals only, the brown lead wire of the B7AP-M1 Power Coupler must not be used. Insulate the brown lead wire with insulation tape so that the brown wire will not come in contact with any lead wire.
3. The maximum input points of the B7A Input Unit are available.
4. PLCs and three-wire sensors can be connected to the B7A Input Unit.

Indicators

Indicators		Function
Power indicator		Lit green when power is supplied to the Power Coupler.
		Not lit when power is not supplied to the Power Coupler.
Operation indicator		Lit green when the Power Couplers are properly set for power transmission at a transmission distance of 8±1.5 mm.
		Not lit when the Power Couplers are not properly set for power transmission, or the Power Coupler has excessive loads.

B7AP-S1

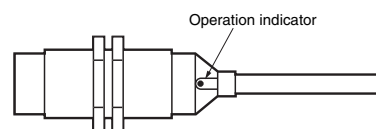

B7AP-M1

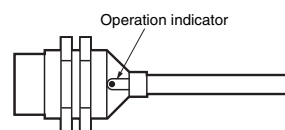

Safety Precautions

⚠ WARNING

This product is not designed or rated for ensuring safety of persons. Do not use it for such purposes.



Precautions for Safe Use

Be careful when touching the B7AP-S1 (Stationary Unit) Power Coupler during operation because the surface temperature of the B7AP-S1 Power Coupler will rise approximately 20°C after the B7AP-S1 Power Coupler starts power transmission. The surface temperature varies with the load of the sensing device connected to the B7AP-M1 (Moving Unit) Power Coupler and the transmission distance.

Precautions for Correct Use

Do not use this product under ambient conditions that exceed the ratings.

Handling

1. Use the B7AP-S1 and B7AP-M1 Power Couplers with the available B7A Link Terminals shown in Connectable B7A Models on page 3.
The M7E-12□□ Display Unit, M7E-20□□ Display Unit, B7A-T10M2, B7AC-T10A1, and 16-point High-speed model cannot be connected to the Power Controller.
2. Use the LOAD-OFF model for the B7A Output Unit to be connected to the B7AP-S1 Stationary Unit. The LOAD-OFF model turns OFF all outputs when there is no transmission between the B7AP Power Couplers.
3. The B7AP Power Couplers must be separated by at least 30 mm to prevent transmission.

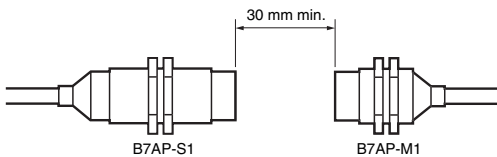

4. Do not supply power to the B7AP-S1 or B7AP-M1 Power Coupler while connecting the Power Couplers to the B7A Link Terminals. Connect the Power Couplers to the B7A Link Terminals correctly, otherwise the internal circuits of the Power Couplers may be damaged.
5. The SIG terminal must not contact with the power supply terminals, otherwise the internal element may be damaged and normal transmission may not be possible.

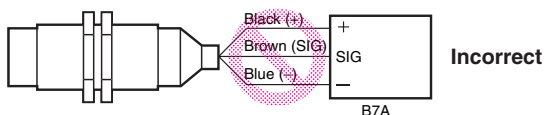
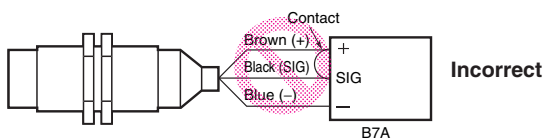
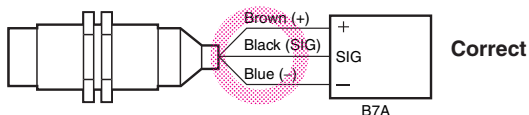

6. Wire the cables of the B7AP-S1 and B7AP-M1 Power Couplers through independent metal conduits to prevent the Power Couplers from being influenced by noise if there are power or high-tension lines nearby. Test the Power Couplers and make sure that the Power Couplers operate normally before they are put in actual operation.

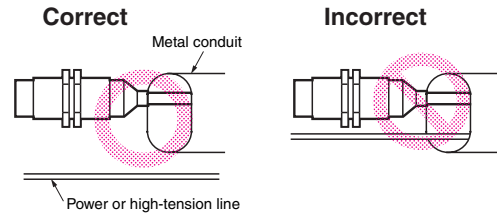

7. Do not subject the head of the B7AP-S1 or B7AP-M1 Power Coupler to excessive shock with hard objects.

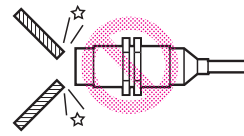

8. Do not use the B7AP-S1 or B7AP-M1 Power Coupler outdoors unless it is properly protected.

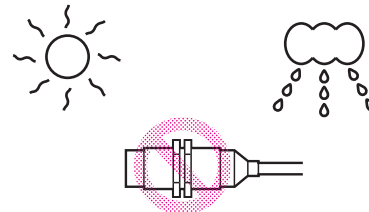

9. Degree of Protection

The B7AP-S1 and B7AP-M1 Power Couplers are products meeting the requirements of IP67. (They are not fully sealed water-tight models.) The B7AP-S1 or B7AP-M1 Power Coupler cannot be, however, used in water or oil.

10. Keep the heads of the B7AP-S1 and B7AP-M1 Power Couplers free from dust, otherwise improper signal or power transmission may result between the Power Couplers.
11. When complying with UL standards, install a device between the external power supply and the B7AP-S1 that limits the current to 5 A.

Mounting

Use nuts and serrated toothed washers and tighten the nuts. The torque is 39 N·m maximum. The mounting position will change and improper signal or power transmission may result between the Power Couplers if the nuts are not tightened properly.

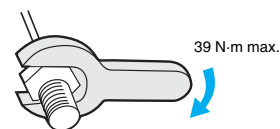

Transmission Distance for Stable Signal and Power Transmission

Use the gauge to adjust the transmission distance to 8 mm, make sure that the green operation indicator of the B7AP-M1 Power Coupler is lit, and the B7A Output Unit has no error output before operating the Power Couplers.

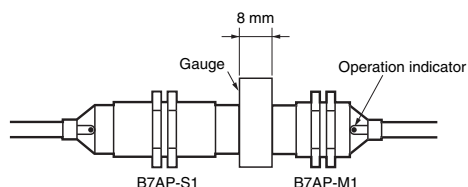

Monitoring Transmission Status

Judge from the power supply/error indicator and error output of the B7A Output Unit whether the B7AP-S1 and B7AP-M1 Power Couplers are facing each other properly. (Use the B7A Output Unit power and error indicator, and error terminal.) The error output of the B7A Output Unit will be ON when the B7AP-S1 and B7AP-M1 Power Couplers are not facing each other properly.

Minimum Distance between Power Couplers Mounted in Parallel

When mounting the B7AP-S1 and B7AP-M1 Power Couplers in parallel, refer to the following table. Keep at least the specified minimum distance between adjacent Power Couplers for proper heat radiation by considering the temperature rise (approximately 20°C) of the B7AP-S1 Power Couplers in operation.

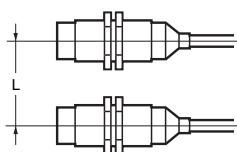

(Unit: mm)

Dimensions	Model	B7AP-S1	B7AP-M1
L		60	60

Effects of Surrounding Metal

The B7AP Power Coupler may malfunction when affected by surrounding metal. When mounting the B7AP within a metal panel, ensure that the clearances given in the following table are maintained. Be sure to check in advance that the B7AP operates properly.

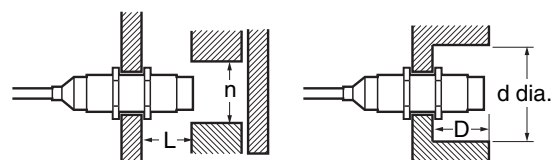

(Unit: mm)

Dimensions	Model	B7AP-S1	B7AP-M1
L		20	20
d		60 dia.	60 dia.
D		20	20
n		60	60

Maintenance

As with other control devices, regularly check the following to ensure the long-term stable operation of the B7AP-S1 and B7AP-M1 Power Couplers.

1. The mounting positions, misalignment, tightening of the mounting nuts, and warping.
2. The tightening, contacts, and breaking of the lead wires.
3. Dust accumulation on the heads.
4. The ambient operating temperature and other operating conditions.
5. The transmission distance.

(Unit: mm)

Dimensions

Unless otherwise specified, the tolerance class IT16 is used for dimensions in this data sheet.

B7AP-S1

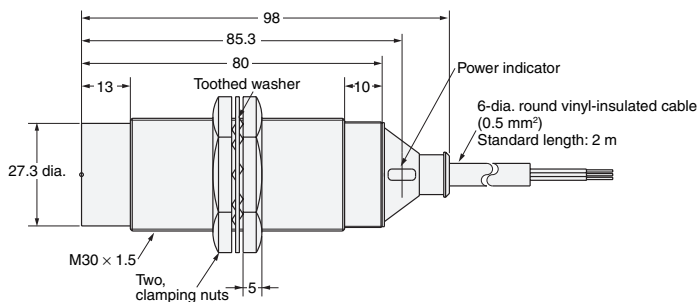
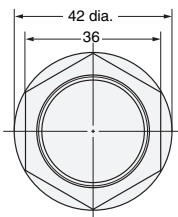
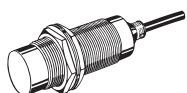

Mounting Holes

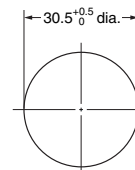

B7AP-M1

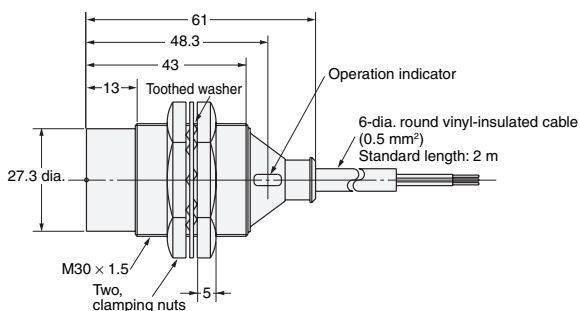
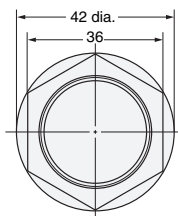

Mounting Holes

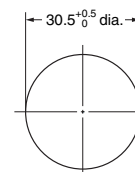

In the interest of product improvement, specifications are subject to change without notice.

Read and Understand This Catalog

Please read and understand this catalog before purchasing the products. Please consult your OMRON representative if you have any questions or comments.

Warranty and Limitations of Liability

WARRANTY

OMRON's exclusive warranty is that the products are free from defects in materials and workmanship for a period of one year (or other period if specified) from date of sale by OMRON.

OMRON MAKES NO WARRANTY OR REPRESENTATION, EXPRESS OR IMPLIED, REGARDING NON-INFRINGEMENT, MERCHANTABILITY, OR FITNESS FOR PARTICULAR PURPOSE OF THE PRODUCTS. ANY BUYER OR USER ACKNOWLEDGES THAT THE BUYER OR USER ALONE HAS DETERMINED THAT THE PRODUCTS WILL SUITABLY MEET THE REQUIREMENTS OF THEIR INTENDED USE. OMRON DISCLAIMS ALL OTHER WARRANTIES, EXPRESS OR IMPLIED.

LIMITATIONS OF LIABILITY

OMRON SHALL NOT BE RESPONSIBLE FOR SPECIAL, INDIRECT, OR CONSEQUENTIAL DAMAGES, LOSS OF PROFITS OR COMMERCIAL LOSS IN ANY WAY CONNECTED WITH THE PRODUCTS, WHETHER SUCH CLAIM IS BASED ON CONTRACT, WARRANTY, NEGLIGENCE, OR STRICT LIABILITY.

In no event shall the responsibility of OMRON for any act exceed the individual price of the product on which liability is asserted.

IN NO EVENT SHALL OMRON BE RESPONSIBLE FOR WARRANTY, REPAIR, OR OTHER CLAIMS REGARDING THE PRODUCTS UNLESS OMRON'S ANALYSIS CONFIRMS THAT THE PRODUCTS WERE PROPERLY HANDLED, STORED, INSTALLED, AND MAINTAINED AND NOT SUBJECT TO CONTAMINATION, ABUSE, MISUSE, OR INAPPROPRIATE MODIFICATION OR REPAIR.

Application Considerations

SUITABILITY FOR USE

OMRON shall not be responsible for conformity with any standards, codes, or regulations that apply to the combination of products in the customer's application or use of the products.

At the customer's request, OMRON will provide applicable third party certification documents identifying ratings and limitations of use that apply to the products. This information by itself is not sufficient for a complete determination of the suitability of the products in combination with the end product, machine, system, or other application or use.

The following are some examples of applications for which particular attention must be given. This is not intended to be an exhaustive list of all possible uses of the products, nor is it intended to imply that the uses listed may be suitable for the products:

- Outdoor use, uses involving potential chemical contamination or electrical interference, or conditions or uses not described in this catalog.
- Nuclear energy control systems, combustion systems, railroad systems, aviation systems, medical equipment, amusement machines, vehicles, safety equipment, and installations subject to separate industry or government regulations.
- Systems, machines, and equipment that could present a risk to life or property.

Please know and observe all prohibitions of use applicable to the products.

NEVER USE THE PRODUCTS FOR AN APPLICATION INVOLVING SERIOUS RISK TO LIFE OR PROPERTY WITHOUT ENSURING THAT THE SYSTEM AS A WHOLE HAS BEEN DESIGNED TO ADDRESS THE RISKS, AND THAT THE OMRON PRODUCTS ARE PROPERLY RATED AND INSTALLED FOR THE INTENDED USE WITHIN THE OVERALL EQUIPMENT OR SYSTEM.

PROGRAMMABLE PRODUCTS

OMRON shall not be responsible for the user's programming of a programmable product, or any consequence thereof.

Disclaimers

CHANGE IN SPECIFICATIONS

Product specifications and accessories may be changed at any time based on improvements and other reasons.

It is our practice to change model numbers when published ratings or features are changed, or when significant construction changes are made. However, some specifications of the products may be changed without any notice. When in doubt, special model numbers may be assigned to fix or establish key specifications for your application on your request. Please consult with your OMRON representative at any time to confirm actual specifications of purchased products.

DIMENSIONS AND WEIGHTS

Dimensions and weights are nominal and are not to be used for manufacturing purposes, even when tolerances are shown.

PERFORMANCE DATA

Performance data given in this catalog is provided as a guide for the user in determining suitability and does not constitute a warranty. It may represent the result of OMRON's test conditions, and the users must correlate it to actual application requirements. Actual performance is subject to the OMRON Warranty and Limitations of Liability.

ERRORS AND OMISSIONS

The information in this document has been carefully checked and is believed to be accurate; however, no responsibility is assumed for clerical, typographical, or proofreading errors, or omissions.

2011.7

In the interest of product improvement, specifications are subject to change without notice.

OMRON Corporation
Industrial Automation Company

<http://www.ia.omron.com/>

(c)Copyright OMRON Corporation 2011 All Right Reserved.