

E3C-LDA

1 Setting the Operation Mode

The operation mode is set with the Mode Selector Switch.

Operation mode		Operation
Light ON	L-ON	L (Factory-set)
Dark ON	D-ON	D

*Advanced Twin-output Models:
The operation mode is set in SET mode.
→Refer to 5. **Setting Functions in SET Mode** on page 18.

*Advanced Twin-output Models (Same for All Adjustments):
Set the Channel Selector Switch to the desired channel before making any adjustments or settings.

2 Adjusting the Power (RUN Mode)

The current incident light level can be adjusted to near the power tuning target value (default: 2,000).

*Confirm that the MODE Key setting is PTUN (power tuning). The default setting is PTUN.

→Refer to 5. **Setting Functions in SET Mode** on page 18.

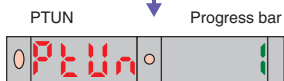
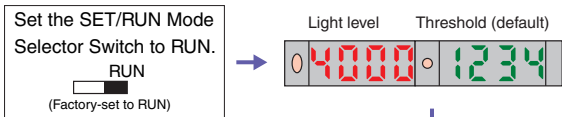

Release the key after the progress bar is displayed.

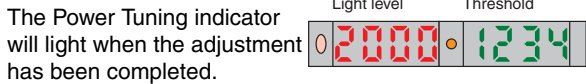
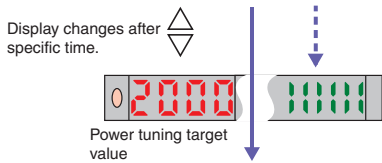

To restore the default power settings:

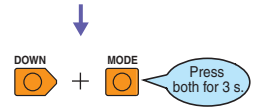

"OFF" will flash twice.



The Power Tuning indicator will go out when the default setting has been restored.

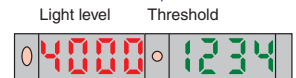

*Setting Errors

An error has occurred if one of the following displays appears after the progress bar is displayed.

Display	Error	Action
<p>PTUN OVER</p>	<p>Flashes twice</p> <p>Over Error The incident light level is too low for the power tuning target value.</p>	<p>The power will not be tuned. The power can be increased up to approximately 1.5 times the incident light value.</p>
<p>PTUN BOTM</p>	<p>Flashes twice</p> <p>Bottom Error The incident light level is too high for the power tuning target value.</p>	<p>The power will be turned to the minimum level. The power can be decreased down to approximately 1/8th the incident light value.</p>

3 Setting Thresholds Manually (RUN Mode)

A threshold can be set manually. A threshold can also be finetuned using manual setting after teaching.

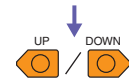
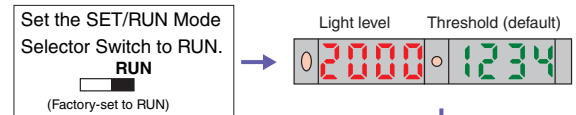

Increases threshold. Decreases threshold.

*Even if the display method for display switching is changed, the threshold will appear on the sub-display when the key is pressed.

4 Teaching the Threshold (SET Mode)

- *There are three methods that can be used for teaching, as described below. Use the method most suitable for the application.
- *Teaching (with/without workpiece teaching and automatic teaching) can be performed in RUN mode.
- For operating procedures, refer to *Instruction Sheet* provided with the product.
- *An error has occurred if OVER, LO, or NEAR is displayed on the sub-display. Repeat the operation from the beginning.

4-1. Teaching a Through-beam Fiber Unit without a Workpiece

A value about 6% less than the incident light level (minimum difference) can be set as the threshold. This method is ideal when detecting very small differences in light level, such as when detecting very fine workpieces or transparent workpieces with a Through-beam (retroreflective) Unit.

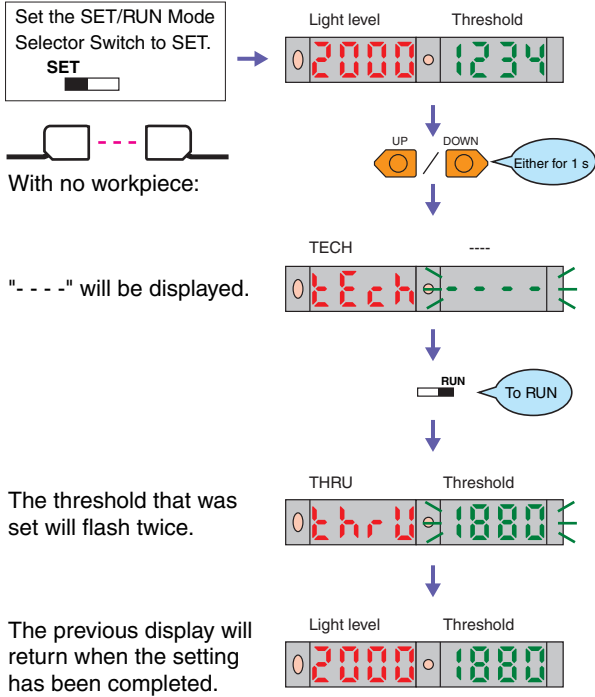

4-2. Teaching a Reflective Fiber Unit without a Workpiece

A value about 6% greater than the incident light level (minimum difference) can be set as the threshold. This method is ideal when using a Reflective Fiber Unit to detect workpieces so that detection is not influenced to any great degree by dust and other environmental factors.

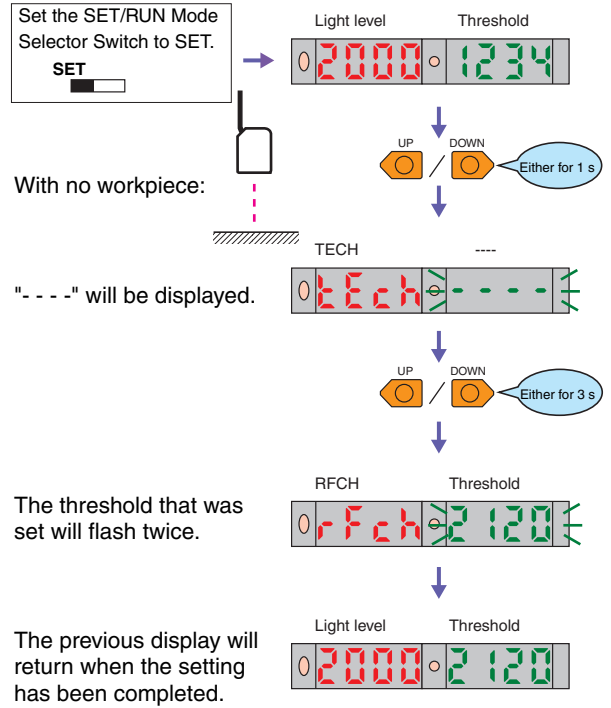

4-3. Teaching With and Without a Workpiece

Two points, with and without the workpiece, are detected, and the intermediate point is set as the threshold.

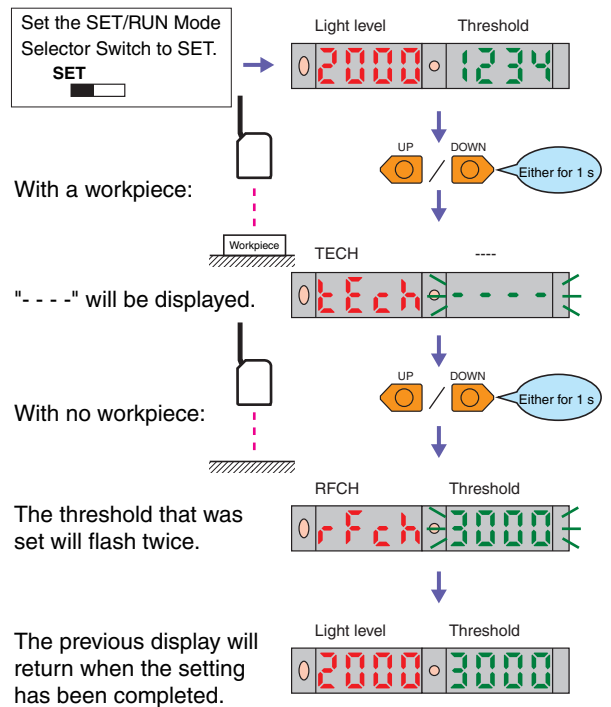

5 Setting Functions in SET Mode

Twin-output and ATC Models

E3C-LDA11/LDA41/LDA6/LDA8
E3C-LDA11AT/LDA41AT/LDA6AT/LDA8AT

*The function transition boxes show the default settings.
Enter the functions by pressing the **MODE** Key.
To set the functions, refer to the list of functions and use the **UP** / **DOWN** UP and DOWN Keys.

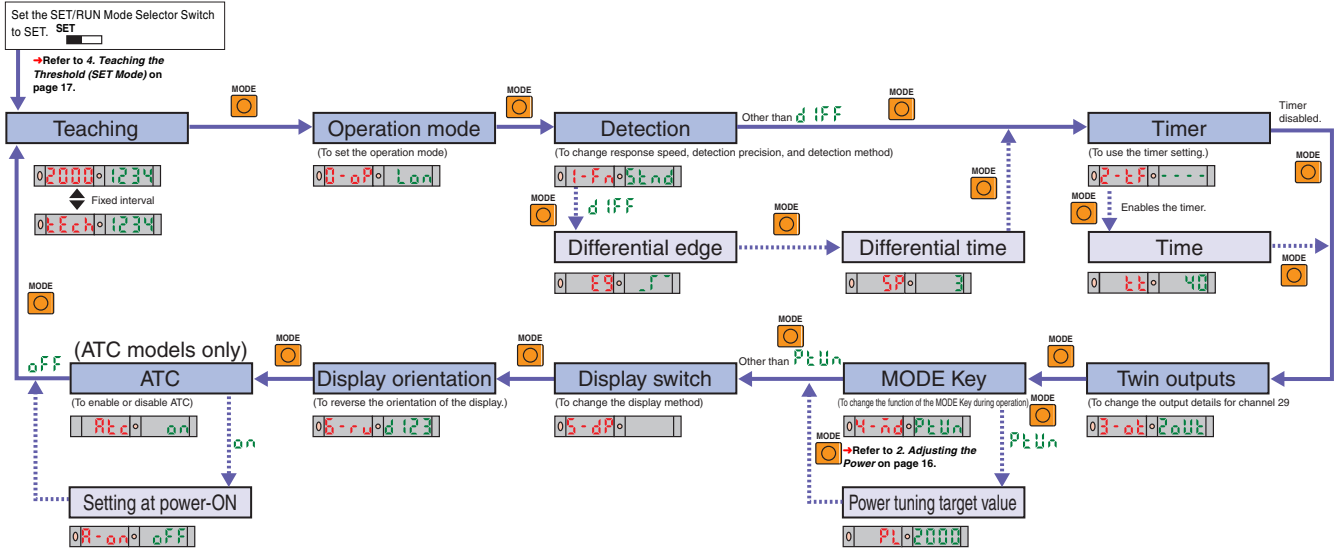





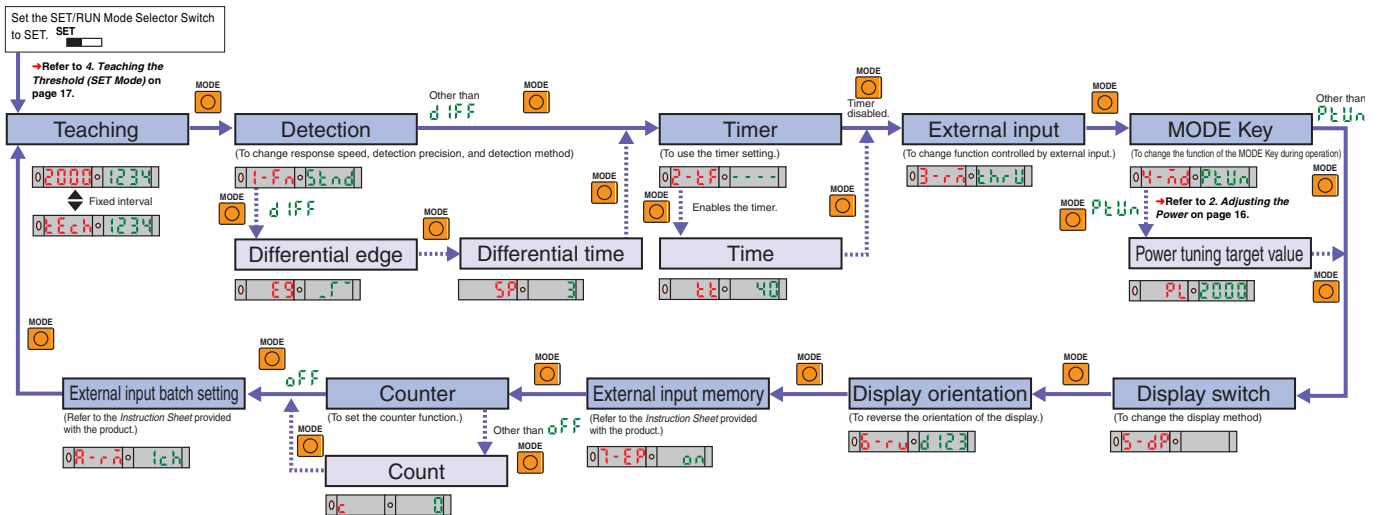

External Input Models

E3C-LDA21/LDA51/LDA7/LDA9

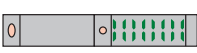

Functions

  Use the UP and DOWN Keys to change the settings.

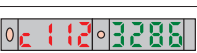
Function	Setting (display)	Description
Detection	Super-high-speed: SXS , High-speed: XS , Standard: Std , High-precision: HP , Differential operation: DIFF (advanced models only)	Used to increase response speed and detection precision.
Differential edge (differential operation selected)	Single edge: _F_ , Double edge: _R_	Used to set the edge to be detected.
Differential time	Single edge...250 μ s: 1 , 500 μ s: 2 , 1 ms: 3 , 10 ms: 4 , 100 ms: 5 , Double edge...500 μ s: 1 , 1 ms: 2 , 2 ms: 3 , 20 ms: 4 , 200 ms: 5	Used to set the differential response time.
Timer	Timer disabled: --- , OFF-delay timer: OFFd , ON-delay timer: OND , One-shot timer: 1Sh	Used to enable or disable timers.
Time (timer enabled)	1 to 20 ms: 1-ms increments, 20 to 200 ms: 5-ms increments, 200 ms to 1 s: 100-ms increments, 1 to 5 s: 1-s increments	Used to change timer setting when timer is enabled. The timer can be set from 1 to 5000 ms.
MODE Key	Executes power tuning: PtUn , Executes a zero reset: GrSt , With/without workpiece teaching: ZPnt , Automatic teaching: Aut	Used to change the function of the MODE Key during operation.
Power tuning target value (performing power tuning)	Setting range: 100 to 3,900 (increments of 100) Maximum power M: FULL	Used to set the target value during power tuning.
Display switch	 Light level Threshold	Used to display the incident light level and the threshold.
	 % light level Threshold	Used to display the incident light level as a percentage of the threshold and the threshold.
	 PEAK BOTM Fixed interval	Used to display the peak and bottom levels of incident light within a set time. (Updated every 2 s.)
	 L-PE D-BT	Used to display the incident light peak level and no incident light bottom level. (Refreshed when output turns ON or OFF.)
	 Detection status	Analog bar display. The current detection status is displayed as an analog bar. The bar will lengthen from the right as ON status is reached. (ON: Red; OFF: Green)
	 Current light level PEAK Fixed interval Current light level Peak light level	Used to display the current incident light level and the peak incident light level. Display changes at a fixed interval.
	 Light level Channel	Used to display the incident light level and the channel.
	 Count (For external input models only)	Used to display the counter value.
Display orientation	Normal display: d123 , Up/down reversed display: E21P	Used to reverse the orientation of the display.
Operation mode* (twin-output models only)	Light ON: Lon , Dark ON: don	→Refer to 1. Setting the Operation Mode on page 16.
Twin outputs (twin-output models only)	Output for each channel: Zout , Output if level is between the two thresholds: RrER , Self-diagnosis output: SELF	Used to change the output for channel 2. This setting is disabled if differential operation is set for the detection function. (Alarm outputs are always used for differential operation.)
ATC (ATC models only)	ATC enabled: on , ATC disabled: off	Used to enable or disable ATC.
Setting at Power-ON (ATC ON)	No setting: off , ATC start processing: Atc , Power tuning and ATC start processing: PtAt	Used to set the processing to be performed when the power is turned ON.
External input (external input models only)	Thru-beam, no-workpiece teaching: thru , Reflective, no-workpiece teaching: rFct , With/Without-workpiece teaching: ZPnt , Automatic teaching: Aut , Power tuning: PtUn , Zero reset: GrSt , Light OFF: LoFF , Counter reset: crSt	Used to change function controlled by external input. (Refer to Instructions provided with the product.)
External input memory (external input models only)	Write results to EEPROM: on , Don't write results: off	Used to set writing the results. (Refer to Instructions provided with the product.)
Counter (external input models only)	Counter disabled: off , Count incremented when output turns ON: cUP , Count decremented when output turns ON: cd	Used to set the counter function.
Count	Setting range: 1 to 9,999,999	Used to set the counter value when the counter function is enabled.
External input batch setting (external input models only)	Only sensor that receives external input: lch , All linked sensors: ALL	Used to set linked Amplifiers at the same time using an external input.

*The operation mode and timer function can be set for each channel specified using the Channel Selector Switch. The settings for other functions will be the same for channel 1 and channel 2.

6 Convenient Functions

6-1. Zeroing the Digital Display (Zero Reset)

The incident light level on the main display can be set to 0.

* Change the function to 0RST (zero reset) with the MODE Key. The default setting is PTUN.

Set the SET/RUN Mode Selector Switch to RUN.

 Factory setting



To reset to 0 again:



To return to original value for incident light level:



6-2. Locking the Keys (Key Lock)

All key operations can be disabled.

Set the SET/RUN Mode Selector Switch to RUN.

 Factory setting

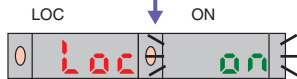

"ON" will flash twice and key operations will be disabled.

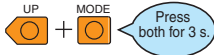

To release the lock:



"OFF" will flash twice and key operations will be disabled.

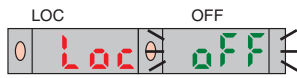

* If a key is pressed while key operations are locked, "LOC" will flash twice on the display to indicate that key operations have been disabled.



6-3. Initializing Settings (Initial Reset)

All settings can be returned to their original default settings.

Set the SET/RUN Mode Selector Switch to SET.

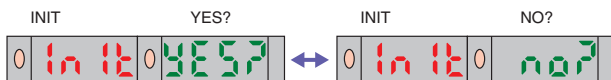
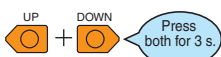
 Factory setting



Settings initialized.

Operation canceled.