

Introduction

What Is a Thumbwheel Switch?

A Thumbwheel Switch is a setting switch that converts the numeric value selected by turning a disk-shaped part on which numbers are written into a binary, decimal, hexadecimal, or other code using the combination of ON and OFF signals for multiple contact circuits and that outputs the resulting code.

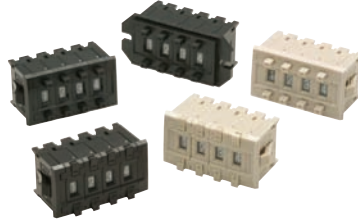











Features

Thumbwheel switches easily convert values to binary, decimal, or hexadecimal codes.

Visually checking initial values	The selected value is displayed as is, so you can always check the set value visually. This makes it easier to prevent incorrect operation.
Maintaining set values	Conversion to a code uses only a mechanical mechanism, so the set value is maintained whether the power is ON or OFF.
Easy digital conversion	Conversion to a code is easy, which makes circuits and wiring simple and improves control system reliability and maintainability.

Types

OMRON's Thumbwheel Switch lineup is based on dimensions to match the scale of the device or equipment the Thumbwheel Switches is mounted in. Thumbwheel Switches are also divided by mounting method into screw-fastened and snap-in switches. There are also Thumbwheel Switches that have a lock function that locks the set values and prevents them from being changed, as well as Thumbwheel Switches that can only be operated with a pen tip or other thin object. First, select the external size that matches the device or equipment the Switch will be mounted in.

		PCB terminals		Solder terminals	
Thumbwheel-operated Switches	Snap-in mounting	 Character height: 2.8 mm			
	Screw mounting	 Character height: 3.2 mm	 Character height: 3.4 mm		
Push-operated Switches	Snap-in mounting	 Character height: 3.2 mm	 Character height: 3.4 mm	 Character height: 3.2 or 4.8 mm	
		 Pen-push models Character height: 3.2 mm	 Locking-type models Character height: 3.4 mm	 Locking-type models Character height: 4.8 mm	 Character height: 4.0 or 6.8 mm
Dimensions (W x H)		5.08 x 16 mm	8 x 18 mm	8 x 24 mm	10 x 33 mm

Compact Business and consumer device applications

Industrial machinery and equipment applications **Large**

Structure

Our typical Thumbwheel Switch consists of a case, push buttons, slider, rotor, seal plate, packing, PCB, end caps, and other parts.

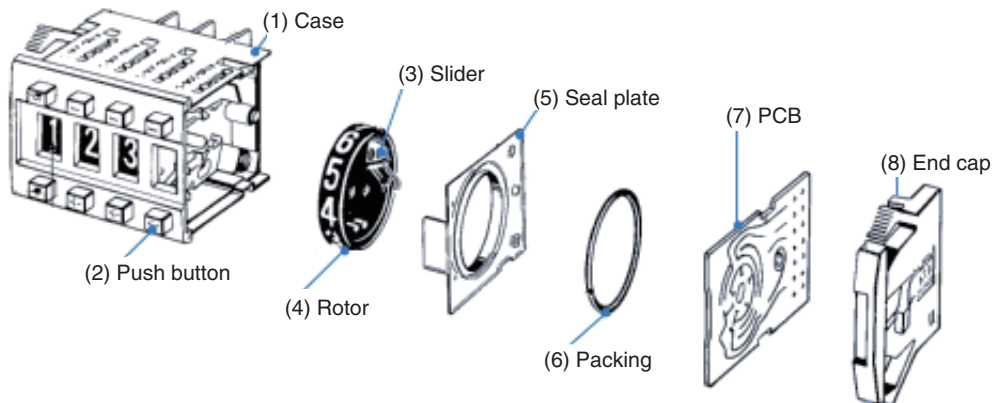

(1)	Case	The case holds the components. The case sides have a mechanism for connecting Switches together in a single operation.
(2)	Push button	There is a plus push button for normal rotation and a minus push button for reverse rotation to set the value. Each push button has a mechanism to provide a click and to smoothly turn the rotor one step each time the push button is pressed.
(3)	Slider	The slider is fastened to the rotor. As the rotor turns, the tip of the slider slides on the PCB. The slider works as a moving contact that turns switch circuits ON and OFF by contacting different parts of the conductive pattern printed on the PCB. Gold alloy is used on the slider tip, which makes contact with the PCB, in order to enhance the contact reliability.
(4)	Rotor	The rotor is a disk-shaped part with numbers written on its circumferential surface. Turning the rotor sets the value of the Switch.
(5)	Seal plate	The seal plate is a transparent plastic part that keeps out foreign substances. It is also the cover for the display window.
(6)	Packing	The packing is made of elastic rubber. It is sandwiched between the PCB and the seal plate and keeps foreign substances out where the PCB makes contact with the slider.
(7)	PCB	The conductive pattern is plated with highly corrosion-resistant gold and maintains high contact reliability with the slider. A pattern with one circuit for each rotation angle is formed in order to convert the switch position into a numeric code.
(8)	End caps	End Caps are mounted on the Switch Units at each end. The Switch is installed by just pushing the mechanism on the End Caps into the corresponding hole.

Explanation of Terms

Output Codes

Term	Meaning
Decimal Code	Uses the ten digits: 0, 1, 2, 3, 4, 5, 6, 7, 8, 9.
Binary Coded Decimal Code	Each decimal number is represented by a binary code (see following table).
Binary Coded Hexadecimal Code	Each hexadecimal numeral is represented by a binary code. 0, 1, 2, 3, 4, 5, 6, 7, 8, 9, A, B, C, D, E, and F represent the sixteen possible values.

+/- Dial Display (“-PM” Models)

It is possible to produce 06-type models (binary coded decimal code) that display “+,-, +...-” instead of “1, 2, 3...9”. The model numbers used for this type of Switch are A7□-206-PM and A7□-206-PM-1. Below is an example of the A7BS-206-PM. The Switch's output terminal 1 and common terminal are used for binary output.

Thumbwheel Switch
A7BS-206-PM

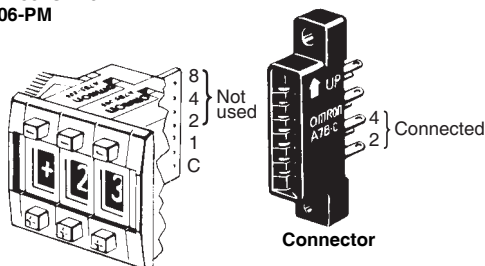

Example of A7BS-206-PM

Model	Switch Unit or Connector	Common terminal number	Terminals connected to common			
A7BS	Switch Unit	C	1	2	4	8
	Connector	2	4	5	6	7
Dial	+ (0)					
	- (1)		●			
	+ (2)			●		
	- (3)		●	●		
	+ (4)					●
	- (5)		●			●
	+ (6)			●	●	
	- (7)		●	●	●	
	+ (8)					●
- (9)		●			●	

Note: 1. The solid dot ● indicates that the internal switch is ON.
2. Numbers enclosed in parentheses are the dial displays for the A7BS-206.

Attaching Stoppers

Stoppers are mechanisms for preventing the wheels rotating outside set ranges. There are internal stoppers that are set at setup and external stoppers that can be set as required at any time. For example, a wheel that normally displays any number in the range 0 to 9 can be restricted to the range 0 to 5 using a stopper.

- Add -S□□ to the suffix, specifying the range in the blanks.
Example: A7PS-203-S05
- Units to which stoppers can be attached are the A7DP, A7D, A7BS, A7BL, A7PS, A7PH, and A7AS. Consult your OMRON representative for details on individual model numbers.
- On the outside of the A7BS-□-S is a Stopper Pin with which the user can make any setting.
- The A7CN-2, A7CN-1, A7CN-L2, A7MD, and A7MA cannot be equipped with stoppers.

Built-in Diodes

“-D” Models (Cathode Common)

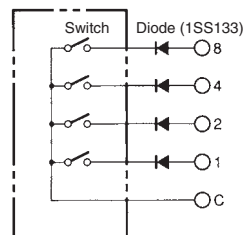

- Applicable Models:
- A7BS-207/-255
 - A7BL-207
 - A7PS-207/-255
 - A7PH-207

“-D1” Models (Anode Common) (Special specification)

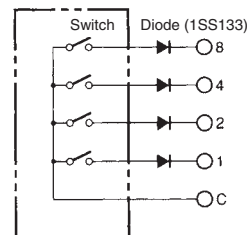

- Applicable Models:
- A7BS-207
 - A7PS-207
 - A7PH-207