

CJ-series Ethernet Unit

CJ1W-ETN21

CSM_CJ1W-ETN21_DS_E_6_9

Organically Connect the Production Site and Management

- Select the required communications services according to application needs to flexibly integrate PLCs with an Ethernet information network.



CJ1W-ETN21

Features

- Use Ethernet to implement various communications protocols.
- Implement FINS message communications using UDP/IP or TCP/IP with a user application on a host computer or with Support Software, such as the CX-Programmer.
- Use the clock on an SNTP server to automatically adjust the clocks in the PLCs connected to the Ethernet network. (An SNTP server is required separately.)
- An FTP server is built in, so files can be used to transfer PLC data between network PLCs and workstations or personal computers with an FTP client.
- Email can be used to send commands to the PLCs, or triggers can be set so that the PLCs will send PLC data or Ethernet Unit status to a host computer.
- The standard UDP/IP and TCP/IP protocols are supported to enable communications with a wide range of devices, workstations, personal computers, and Ethernet modules from other manufacturers.
- The SMTP/POP3/SNTP servers enable the use of host names instead of IP addresses. (A DNS server is required separately.)

System Configuration

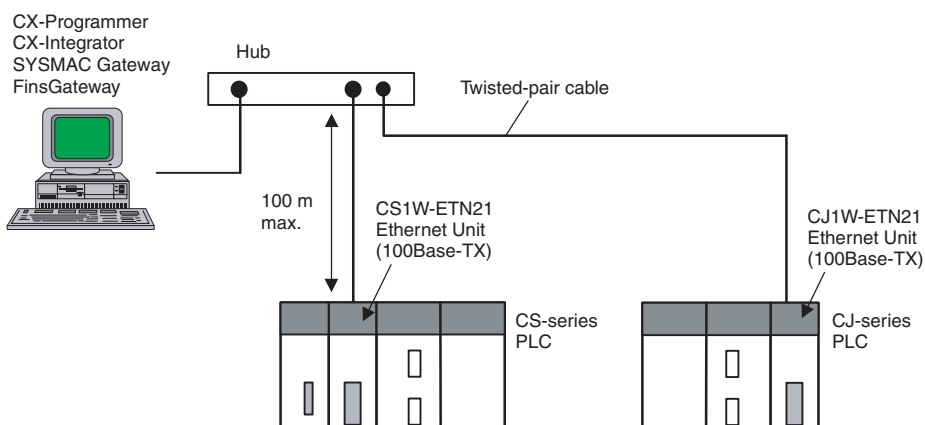

Ordering Information

Applicable standards

Refer to the OMRON website (www.ia.omron.com) or ask your OMRON representative for the most recent applicable standards for each model.

Ethernet Unit

Unit type	Product name	Specifications			No. of unit numbers allocated	Current consumption (A)		Model
		Communications cable	Communications functions	Units per CPU Unit		5 V	24 V	
CJ1 CPU Bus Unit	Ethernet Unit 	100Base-TX	FINS communications service (TCP/IP, UDP/IP), FTP server functions, socket services, mail transmission service, mail reception (remote command receive), automatic adjustment of PLC's built-in clock, server/host name specifications	4 *	1	0.37	–	CJ1W-ETN21

Note: 1. There is no accessory for the CJ-series Ethernet Unit.

2. This unit cannot be used with the Machine Automation Controller NJ-series.

* Up to three Ethernet Units can be connected to a CJ1M-CPU1□-ETN CPU Unit. (Final order entry date for CJ1M: The end of March, 2021)

Industrial Switching Hubs

Product name	Appearance	Functions	No. of ports	Accessories	Current consumption (A)	Model
Industrial Switching Hubs		Quality of Service (QoS): EtherNet/IP control data priority 10/100BASE-TX, Auto-Negotiation	5	Power supply connector	0.07	W4S1-05D

Recommended Network Devices

The following products are recommended for use with the Ethernet Unit.

Part	Maker	Model number	Contact phone
Sizes and conductor pairs: AWG 24 × 4 pairs	Cables	Tonichi Kyosan Cable, Ltd. NETSTAR-C5E SAB 0.5 × 4P CP	Kanetsu Planning Department
	RJ45 Connectors	Kuramo Electric Co., Ltd. KETH-SB	Kuramo Electric Co., Ltd.
Sizes and conductor pairs: AWG 22 × 2 pairs	Cables	Panduit Corporation MPS588	Panduit Corporation, Japan Branch, Osaka Sales Office
	RJ45 Assembly Connectors	Kuramo Electric Co., Ltd. KETH-PSB-OMR	Kuramo Electric Co., Ltd.
Sizes and conductor pairs: 0.5 mm × 4 pairs	Cables	OMRON XS6G-T421-1	OMRON Corporation, Customer Support Center
	RJ45 Connectors	EtherNet compliant cable	
Boots	Panduit Corporation MPS588	Panduit Corporation, Japan Branch, Osaka Sales Office	
	TSUKO	MK Boots (VI) LB	TSUKO

Mountable Racks

Model	NJ system		CJ system (CJ1, CJ2)		CP1H system	NSJ system *1	
	CPU Rack	Expansion Rack	CPU Rack	Expansion Backplane	CP1H PLC	NSJ Controller	Expansion Backplane
CJ1W-ETN21	Not Supported		4 Units (per CPU Unit) *2		2 Units *3	Not supported	4 Units *4

*1. Product no longer available to order.

*2. Up to three Ethernet Units can be connected to a CJ1M-CPU1□-ETN CPU Unit. (Final order entry date for CJ1M: The end of March, 2021)

*3. A CP1W-EXT01 CJ Unit Adaptor is required.

*4. If an Expansion Rack is used, the NSJW-CLK21-V1 or NSJW-ETN21 cannot be mounted to the NSJ Controller.

Ethernet Units Specifications

Item		Specifications	
Model number		CJ1W-ETN21	
Type		100Base-TX (Can be used as 10Base-T)	
Applicable PLCs		CJ-series PLCs	
Unit classification		CJ-series CPU Bus Unit	
Mounting location		CPU Rack or Expansion Rack	
Number of Units that can be mounted		4 max. (including Expansion Racks)	
Transfer specifications	Media access method	CSMA/CD	
	Modulation method	Baseband	
	Transmission paths	Star form	
	Baud rate	100 Mbit/s (100Base-TX)	10 Mbit/s (10Base-TX)
	Transmission media	Unshielded twisted-pair (UDP) cable Categories: 5, 5e Shielded twisted-pair (STP) cable Categories: 100 Ω at 5, 5e	Unshielded twisted-pair (UDP) cable Categories: 3, 4, 5, 5e Shielded twisted-pair (STP) cable Categories: 100 Ω at 3, 4, 5, 5e
	Transmission distance	100 m (distance between hub and node)	
Number of cascade connections		No restrictions if switching hubs are used.	
Current consumption (Unit)		370 mA max. at 5 V DC	
Weight		100 g max.	
Dimensions		31 × 90 × 65 mm (W × H × D)	
Other general specifications		Other specifications conform to the general specifications of the CJ-series.	

Communications Specifications

Item	Ethernet Unit	
Model number	CJ1W-ETN21	
Physical layer	100BASE-TX, 10BASE-T	
Number of nodes on FINS network	254	
Server specification	Specification by IP address or host name specifications (DNS client function)	
Communications service	FINS communications service	FINS/UDP FINS/TCP
	FTP server function	The CPU Unit's file memory (Memory Card or EM file memory) can be read/written.
	Automatic clock information adjustment	The CPU Unit's internal clock data can be automatically adjusted to the clock data received from the SNTP server
	Web functions	The Unit settings can be made and status can be read from the Web browser using the Web server.
	Mail functions	Mail send functions Mail receive functions
	Socket service function	TCP socket services UDP socket services
	FINS commands	RESET
		CONTROLLER DATA READ
		CONTROLLER STATUS READ
		ECHOBACK TEST
		BROADCAST TEST (READ RESULTS)
		BROADCAST TEST (SEND TEST DATA)
		ERROR LOG READ
		ERROR LOG CLEAR
		REQUEST TO OPEN UDP SOCKET
		REQUEST TO RECEIVE UDP SOCKET
		REQUEST TO SEND UDP SOCKET
		REQUEST TO CLOSE UDP SOCKET
		REQUEST TO OPEN TCP SOCKET (PASSIVE)
		REQUEST TO OPEN TCP SOCKET (ACTIVE)
		REQUEST TO RECEIVE TCP SOCKET
		REQUEST TO SEND TCP SOCKET
		REQUEST TO CLOSE TCP SOCKET
		EXECUTE PING COMMAND
		REQUEST TO CHANGE REMOTE NODE FOR FINS/TCP CONNECTION
		REQUEST TO READ STATUS FOR FINS/TCP CONNECTION
	IP ADDRESS TABLE WRITE	
IP ADDRESS WRITE		
IP ADDRESS TABLE READ		
IP ROUTING TABLE READ		
PROTOCOL STATUS READ		
MEMORY STATUS READ		
SOCKET STATUS READ		
ADDRESS DATA READ		
IP ADDRESS READ		

External Interface

CJ1W-ETN21

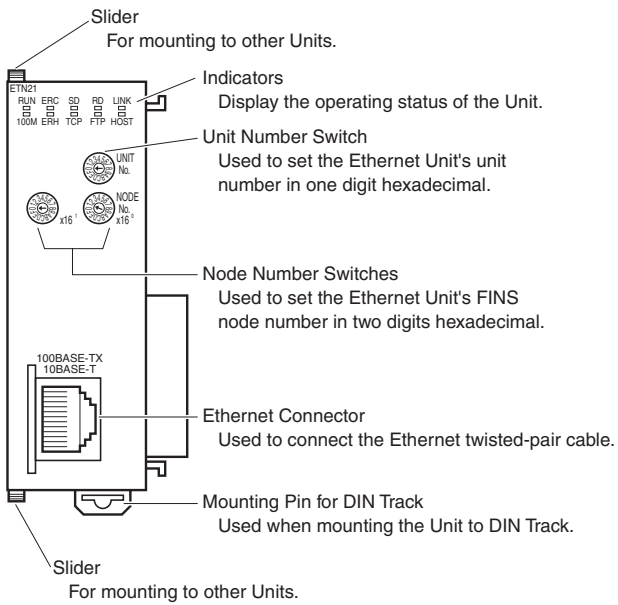

Each communications device connected to the Ethernet network is allocated a unique Ethernet address. For the Ethernet Unit, this Ethernet address is shown on the right side of the Unit as a 12-digit hexadecimal number.

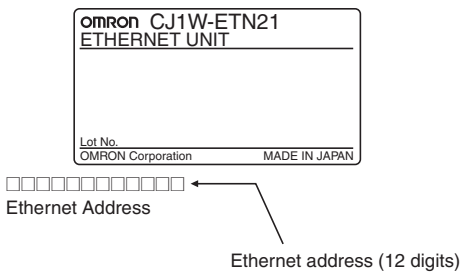

Ethernet Connectors

The following standards and specifications apply to the connectors for the Ethernet twisted-pair cable.

- Electrical specifications: Conforming to IEEE802.3 standards.
- Connector structure: RJ45 8-pin Modular Connector (conforming to ISO 8877)

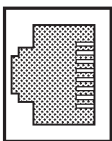

Connector pin	Signal name	Abbr.	Signal direction
1	Transmission data +	TD+	Output
2	Transmission data -	TD-	Output
3	Reception data +	RD+	Input
4	Not used.	-	-
5	Not used.	-	-
6	Reception data -	RD-	Input
7	Not used.	-	-
8	Not used.	-	-
Hood	Frame ground	FG	-

Unit Version Upgrade Information

Unit Version 1.3

Upgrade	Details
Web function added	The unit settings and status monitoring for the Ethernet Unit can be easily performed from a Web browser.
Function prohibiting access using FINS/UDP from nodes with dynamically changed IP addresses	Access to change the remote IP address from a node using FINS/UDP can be prohibited (IP address protection).

Unit Version 1.4

Upgrade	Details
ETN11-compatible mode added to the ETN21 settings for FINS/UDP.	A mode compatible with the CS1W-ETN11/CJ1W-ETN11 was added in the operating specifications for FINS/UDP messages sent from a different UDP port number than the FINS/UDP port number set in the Ethernet Unit.

Unit Version 1.5

Upgrade	Details
CIDR function added to subnet mask settings	An option setting was added to the subnet mask settings to enable CIDR. Enabling CIDR allows you to use classless IP addresses in the subnet mask setting.
High-speed option added for socket service	This option can be set to improve communications performance for the socket service that is implemented by manipulating dedicated control bits. The performance is the same as the previous version if this option is not set.
Linger option added to socket options for TCP open requests.	A linger option can now be set in the options for passive or active TCP open requests.
Location of node address switches changed on CJ1W-ETN21	The location of the node address switches was changed. The setting method and setting range remain the same.

Note: CX-Programmer version 8.2 or higher is required for unit version 1.5 functions.

Dimensions

(Unit: mm)

CJ1W-ETN21

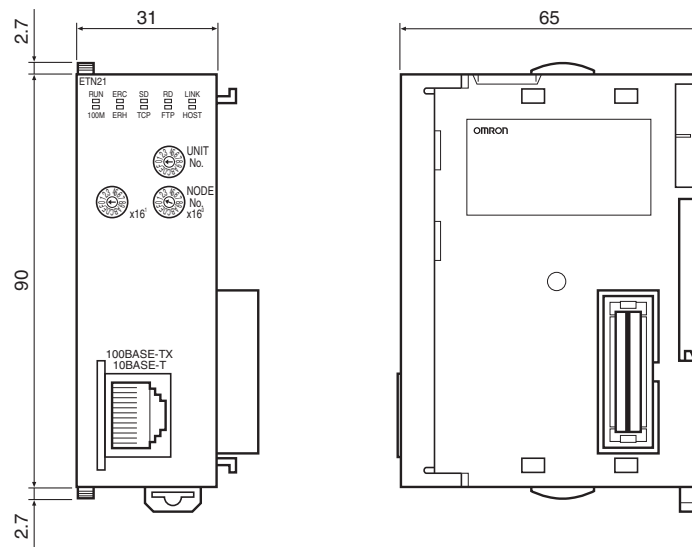

Related Manuals

Man.No.	Model	Name	Contents
W420	CS1W-ETN21 CJ1W-ETN21	Ethernet Units Operation Manual Construction of Networks	Provides information on operating and installing 100Base-TX Ethernet Units, including details on basic settings and FINS communications. Refer to the Communications Commands Reference Manual (W342) for details on FINS commands that can be sent to CS-series and CJ-series CPU Units when using the FINS communications service.
W421	CS1W-ETN21 CJ1W-ETN21	Ethernet Units Operation Manual Construction of Applications	Provides information on constructing host applications for 100Base-TX Ethernet Units, including functions for sending/receiving mail, socket service, automatic clock adjustment, FTP server functions, and FINS communications.
W342	CS1G/H-CPU□□H CS1G/H-CPU-□□EV1 CS1D-CPU□□HA CS1D-CPU□□SA CS1D-CPU□□H CS1D-CPU□□S CJ1M-CPU□□ CS1W-SCU21-V1 CS1W-SCB21-V1/41-V1 CJ1G/H-CPU□□H CJ1G-CPU□□P CJ1G-CPU□□ CJ1W-SCU21-V1/41-V1	Communications Commands Reference Manual	Describes the C-series (Host Link) and FINS communications commands used when sending communications commands to CS-series and CJ-series CPU Units.
W463	CXONE-AL□□D-V□	CX-One Setup Manual	Describes operating procedures for the CX-One FA Integrated Tool Package. Refer to this manual for operating procedures for the CX-One FA Integrated Tool Package.
W464	CXONE-AL□□D-V□	CS/CJ/CP/NSJ-series CX-Integrator Network Configuration Software Operation Manual	Describes the operating procedures for the CX-Integrator.

Terms and Conditions Agreement

Read and understand this catalog.

Please read and understand this catalog before purchasing the products. Please consult your OMRON representative if you have any questions or comments.

Warranties.

(a) Exclusive Warranty. Omron's exclusive warranty is that the Products will be free from defects in materials and workmanship for a period of twelve months from the date of sale by Omron (or such other period expressed in writing by Omron). Omron disclaims all other warranties, express or implied.

(b) Limitations. OMRON MAKES NO WARRANTY OR REPRESENTATION, EXPRESS OR IMPLIED, ABOUT NON-INFRINGEMENT, MERCHANTABILITY OR FITNESS FOR A PARTICULAR PURPOSE OF THE PRODUCTS. BUYER ACKNOWLEDGES THAT IT ALONE HAS DETERMINED THAT THE PRODUCTS WILL SUITABLY MEET THE REQUIREMENTS OF THEIR INTENDED USE.

Omron further disclaims all warranties and responsibility of any type for claims or expenses based on infringement by the Products or otherwise of any intellectual property right. (c) Buyer Remedy. Omron's sole obligation hereunder shall be, at Omron's election, to (i) replace (in the form originally shipped with Buyer responsible for labor charges for removal or replacement thereof) the non-complying Product, (ii) repair the non-complying Product, or (iii) repay or credit Buyer an amount equal to the purchase price of the non-complying Product; provided that in no event shall Omron be responsible for warranty, repair, indemnity or any other claims or expenses regarding the Products unless Omron's analysis confirms that the Products were properly handled, stored, installed and maintained and not subject to contamination, abuse, misuse or inappropriate modification. Return of any Products by Buyer must be approved in writing by Omron before shipment. Omron Companies shall not be liable for the suitability or unsuitability or the results from the use of Products in combination with any electrical or electronic components, circuits, system assemblies or any other materials or substances or environments. Any advice, recommendations or information given orally or in writing, are not to be construed as an amendment or addition to the above warranty.

See <http://www.omron.com/global/> or contact your Omron representative for published information.

Limitation on Liability: Etc.

OMRON COMPANIES SHALL NOT BE LIABLE FOR SPECIAL, INDIRECT, INCIDENTAL, OR CONSEQUENTIAL DAMAGES, LOSS OF PROFITS OR PRODUCTION OR COMMERCIAL LOSS IN ANY WAY CONNECTED WITH THE PRODUCTS, WHETHER SUCH CLAIM IS BASED IN CONTRACT, WARRANTY, NEGLIGENCE OR STRICT LIABILITY.

Further, in no event shall liability of Omron Companies exceed the individual price of the Product on which liability is asserted.

Suitability of Use.

Omron Companies shall not be responsible for conformity with any standards, codes or regulations which apply to the combination of the Product in the Buyer's application or use of the Product. At Buyer's request, Omron will provide applicable third party certification documents identifying ratings and limitations of use which apply to the Product. This information by itself is not sufficient for a complete determination of the suitability of the Product in combination with the end product, machine, system, or other application or use. Buyer shall be solely responsible for determining appropriateness of the particular Product with respect to Buyer's application, product or system. Buyer shall take application responsibility in all cases.

NEVER USE THE PRODUCT FOR AN APPLICATION INVOLVING SERIOUS RISK TO LIFE OR PROPERTY OR IN LARGE QUANTITIES WITHOUT ENSURING THAT THE SYSTEM AS A WHOLE HAS BEEN DESIGNED TO ADDRESS THE RISKS, AND THAT THE OMRON PRODUCT(S) IS PROPERLY RATED AND INSTALLED FOR THE INTENDED USE WITHIN THE OVERALL EQUIPMENT OR SYSTEM.

Programmable Products.

Omron Companies shall not be responsible for the user's programming of a programmable Product, or any consequence thereof.

Performance Data.

Data presented in Omron Company websites, catalogs and other materials is provided as a guide for the user in determining suitability and does not constitute a warranty. It may represent the result of Omron's test conditions, and the user must correlate it to actual application requirements. Actual performance is subject to the Omron's Warranty and Limitations of Liability.

Change in Specifications.

Product specifications and accessories may be changed at any time based on improvements and other reasons. It is our practice to change part numbers when published ratings or features are changed, or when significant construction changes are made. However, some specifications of the Product may be changed without any notice. When in doubt, special part numbers may be assigned to fix or establish key specifications for your application. Please consult with your Omron's representative at any time to confirm actual specifications of purchased Product.

Errors and Omissions.

Information presented by Omron Companies has been checked and is believed to be accurate; however, no responsibility is assumed for clerical, typographical or proofreading errors or omissions.

2022.5

In the interest of product improvement, specifications are subject to change without notice.

OMRON Corporation
Industrial Automation Company

<http://www.ia.omron.com/>

(c)Copyright OMRON Corporation 2022 All Right Reserved.