

CJ-series Interrupt Input Units

CJ1W-INT01

CSM_CJ1W-INT01_DS_E_2_2

High-speed Starting of I/O Interrupt Tasks. Use Up to Two Units for a Total of Up to 32 Interrupt Inputs.

- Receive inputs to start I/O interrupt tasks. When the Interrupt Input Unit receives an input, the CPU Unit will interrupt execution of the cyclic tasks in the normal program and execute an I/O interrupt task.



CJ1W-INT01

Features

- High-speed ON response of 0.05 ms
 - Use up to 32 interrupt inputs with up to two Units per CPU Unit.
 - Applicable with both NPN and PNP output devices. Polarity selection is not required. *
- * The same polarity is used for the same common.

Ordering Information

International Standards

- The standards are abbreviated as follows: U: UL, U1: UL (Class I Division 2 Products for Hazardous Locations), C: CSA, UC: cULus, UC1: cULus (Class I Division 2 Products for Hazardous Locations), CU: cUL, N: NK, L: Lloyd, and CE: EC Directives.
- Contact your OMRON representative for further details and applicable conditions for these standards.

Interrupt Input Units

| Unit type | Product name | Specifications | | | | | | No. of words allocated | Current consumption (A) | | Model | Standards |
|---------------------|---|----------------|-----------------------|---------------------|--|-------------------------------|--------------------------|------------------------|-------------------------|------|------------|---------------|
| | | I/O points | Input voltage current | Commons | Input pulse width conditions | Max. Units mountable per Unit | External connection | | 5 V | 24 V | | |
| CJ1 Basic I/O Units | Interrupt Input Unit  | 16 inputs | 24 VDC, 7 mA | 16 points, 1 common | ON time: 0.05 ms max. OFF time: 0.5 ms max. | 2 | Removable terminal block | 1 word | 0.08 | – | CJ1W-INT01 | UC1, N, L, CE |

Note: 1. Can be used only on CPU Racks, and not on Expansion Racks.

2. The locations where the Units can be mounted depend on the CPU Rack and the CPU Unit model.

CJ2H-CPU6□-EIP: From the slot next to the CPU Unit until the fourth slot.

CJ1G, CJ1H: From the slot next to the CPU Unit until the fifth slot.

CJ1M: From the slot next to the CPU Unit until the third slot. (Final order entry date for CJ1M :The end of March, 2021)

3. With the SYSMAC NJ-series Controllers, Interrupt Input Units can be used as normal Basic Input Units. They cannot be used to start I/O interrupt tasks.

Accessories

There is no accessory for the CJ series Interrupt Input Units.

Mountable Racks

| Model | NJ system | | CJ system (CJ1, CJ2) | | | CP1H system | NSJ system | |
|------------|--------------|------------------|----------------------|---------------------------|---------------------|---------------|----------------|---------------------|
| | CPU Rack | Expansion Rack | CJ1-CPU Rack | CPU Units other than left | Expansion Backplane | CP1H PLC | NSJ Controller | Expansion Backplane |
| CJ1W-INT01 | 2 Units *1*4 | Not supported *3 | Not supported | 2 Units *2 | Not supported *3 | Not supported | Not supported | Not supported *3 |

*1. The Interrupt Input Unit can be mounted in slots 0 to 4 on the CJ1-CPU Rack. An Incorrect Unit/Expansion Rack Connection error will occur if an Interrupt Input Unit is mounted to slot 5 or higher.

*2. Connectable slot position changes with the CPU Unit.

- CJ1M-CPU□□: Slot No.0 to 2
- CJ2H-CPU□□-EIP: Slot No.0 to 3
- CPU Unit other than above: Slot No.0 to 4

If the Unit is mounted to the slot other than above, I/O setting error will occur. (Final order entry date for CJ1M :The end of March, 2021)

*3. An I/O setting error will occur if an Interrupt Input Unit is mounted to an Expansion Rack.

*4. Interrupt Input Units can be used as normal Basic Input Units. They cannot be used to start I/O interrupt tasks.

Specifications

CJ1W-INT01 Interrupt Input Unit (16 Points)

| | |
|---|--|
| Name | 16-point Interrupt Input Unit with Terminal Block |
| Model | CJ1W-INT01 |
| Rated Input Voltage | 24 VDC |
| Rated Input Voltage Range | 20.4 to 26.4 VDC |
| Input Impedance | 3.3 kΩ |
| Input Current | 7 mA typical (at 24 VDC) |
| ON Voltage/ON Current | 14.4 VDC min./3 mA min. |
| OFF Voltage/OFF Current | 5 VDC max./1 mA max. |
| ON Response Time | 0.05 ms max. |
| OFF Response Time | 0.5 ms max. |
| Number of Circuits | 16 (16 points/common, 1 circuit) |
| Number of Simultaneously ON Points | 100% (16 points/common) simultaneously ON (24 VDC) |
| Insulation Resistance | 20 MΩ between external terminals and GR terminal (at 100 VDC) |
| Dielectric Strength | 1,000 VAC between external terminals and GR terminal for 1 minute at a leakage current of 10 mA max. |
| Internal Current Consumption | 80 mA max. |
| Weight | 110 g max. |
| Accessories | None |

Circuit Configuration

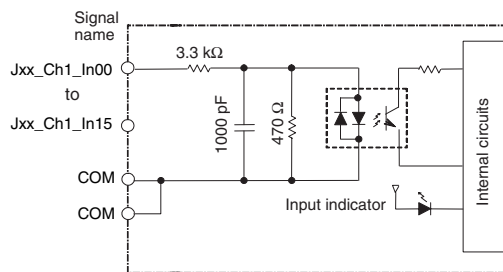

- Up to two Interrupt Input Units can be mounted to the CPU Rack. They must be connected as one of the five Units immediately next to the CPU Unit. If an Interrupt Input Unit is connected in any other position, an Incorrect Unit/Expansion Rack Connection error will occur.
- Set the pulse width of signals input to the Interrupt Input Unit so they satisfy the following conditions.
- The signal names of the terminals are the device variable names. The device variable names are the names that use "Jxx" as the device name.

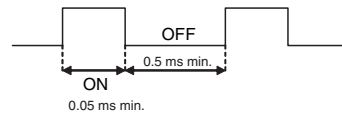
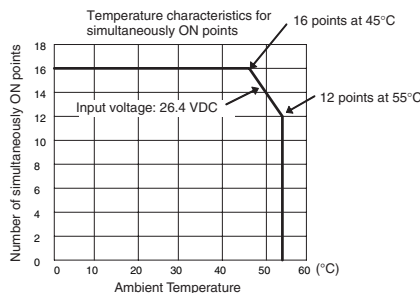

External connection and terminal-device variable diagram

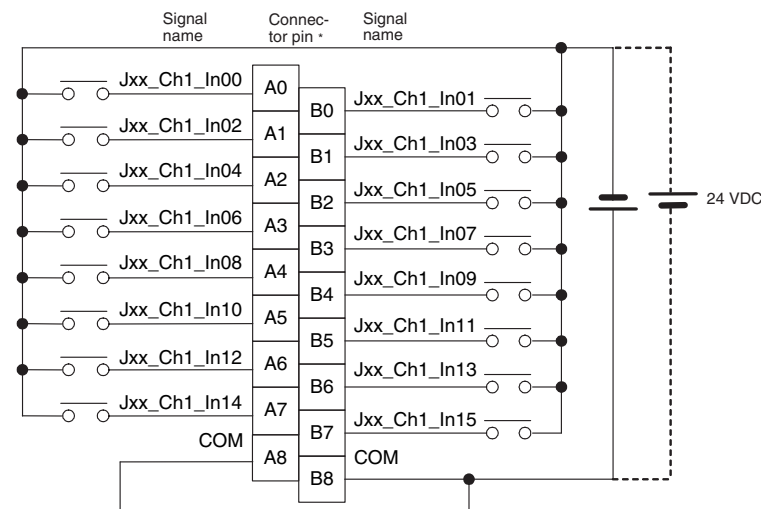

- The polarity can be connected in either direction.
- The signal names of the terminals are the device variable names. The device variable names are the names that use "Jxx" as the device name.

Note: With NJ-series Controllers, Interrupt Input Units can be used as normal Basic Input Units. They cannot be used to start I/O interrupt tasks.

* Terminal numbers A0 to A8 and B0 to B8 are used in the external connection and terminal-device variable diagrams. They are not printed on the Units.

External Interface

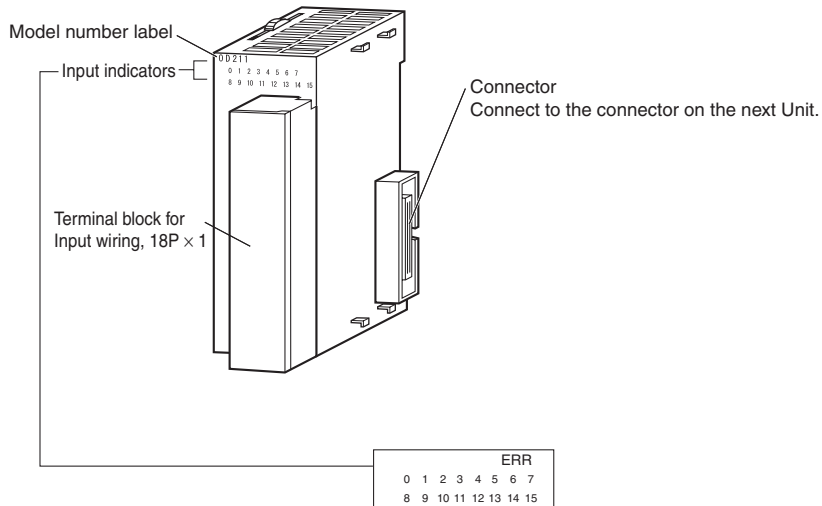

Wiring Terminal Blocks

Electric Wires

The following wire gauges are recommended.

| Terminal Block Connector | Wire Size |
|--------------------------|--|
| 18-terminal | AWG 22 to 18 (0.32 to 0.82 mm ²) |

Crimp terminals

Use crimp terminals (M3) having the dimensions shown below.



Dimensions

(Unit: mm)

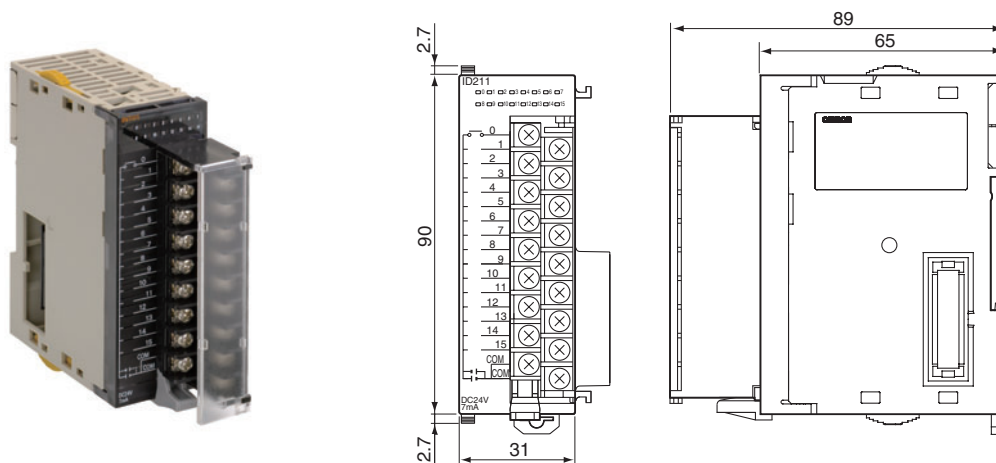

Related Manuals

| Name | Cat. No. | Contents |
|--|----------|---|
| CJ-series CJ2H-CPU6□-EIP, CJ2H-CPU6□, CJ2M-CPU□□ CJ2 CPU Unit Hardware User's Manual | W472 | Describes the following for CJ2 CPU Units: <ul style="list-style-type: none"> • Overview and features • Basic system configuration • Part nomenclature and functions • Mounting and setting procedure • Remedies for errors • Also refer to the Software User's Manual (W473). |
| CJ Series CJ1H-CPU□□H-R, CJ1G/H-CPU□□H, CJ1G-CPU□□P, CJ1G-CPU□□, CJ1M-CPU□□ Programmable Controllers Operation Manual | W393 | Provides an outlines of and describes the design, installation, maintenance, and other basic operations for the CJ-series PLCs. |
| NJ-series CPU Unit Hardware User's Manual NJ501-□□□□ | W500 | An introduction to the entire NJ-series system is provided along with the following information on a Controller built with an NJ501 CPU Unit. <ul style="list-style-type: none"> • Features and system configuration • Introduction • Part names and functions • General specifications • Installation and wiring • Maintenance and inspection Use this manual together with the NJ-series CPU Unit Software User's Manual (Cat. No. W501). |

Terms and Conditions Agreement

Read and understand this catalog.

Please read and understand this catalog before purchasing the products. Please consult your OMRON representative if you have any questions or comments.

Warranties.

(a) Exclusive Warranty. Omron's exclusive warranty is that the Products will be free from defects in materials and workmanship for a period of twelve months from the date of sale by Omron (or such other period expressed in writing by Omron). Omron disclaims all other warranties, express or implied.

(b) Limitations. OMRON MAKES NO WARRANTY OR REPRESENTATION, EXPRESS OR IMPLIED, ABOUT NON-INFRINGEMENT, MERCHANTABILITY OR FITNESS FOR A PARTICULAR PURPOSE OF THE PRODUCTS. BUYER ACKNOWLEDGES THAT IT ALONE HAS DETERMINED THAT THE PRODUCTS WILL SUITABLY MEET THE REQUIREMENTS OF THEIR INTENDED USE.

Omron further disclaims all warranties and responsibility of any type for claims or expenses based on infringement by the Products or otherwise of any intellectual property right. (c) Buyer Remedy. Omron's sole obligation hereunder shall be, at Omron's election, to (i) replace (in the form originally shipped with Buyer responsible for labor charges for removal or replacement thereof) the non-complying Product, (ii) repair the non-complying Product, or (iii) repay or credit Buyer an amount equal to the purchase price of the non-complying Product; provided that in no event shall Omron be responsible for warranty, repair, indemnity or any other claims or expenses regarding the Products unless Omron's analysis confirms that the Products were properly handled, stored, installed and maintained and not subject to contamination, abuse, misuse or inappropriate modification. Return of any Products by Buyer must be approved in writing by Omron before shipment. Omron Companies shall not be liable for the suitability or unsuitability or the results from the use of Products in combination with any electrical or electronic components, circuits, system assemblies or any other materials or substances or environments. Any advice, recommendations or information given orally or in writing, are not to be construed as an amendment or addition to the above warranty.

See <http://www.omron.com/global/> or contact your Omron representative for published information.

Limitation on Liability: Etc.

OMRON COMPANIES SHALL NOT BE LIABLE FOR SPECIAL, INDIRECT, INCIDENTAL, OR CONSEQUENTIAL DAMAGES, LOSS OF PROFITS OR PRODUCTION OR COMMERCIAL LOSS IN ANY WAY CONNECTED WITH THE PRODUCTS, WHETHER SUCH CLAIM IS BASED IN CONTRACT, WARRANTY, NEGLIGENCE OR STRICT LIABILITY.

Further, in no event shall liability of Omron Companies exceed the individual price of the Product on which liability is asserted.

Suitability of Use.

Omron Companies shall not be responsible for conformity with any standards, codes or regulations which apply to the combination of the Product in the Buyer's application or use of the Product. At Buyer's request, Omron will provide applicable third party certification documents identifying ratings and limitations of use which apply to the Product. This information by itself is not sufficient for a complete determination of the suitability of the Product in combination with the end product, machine, system, or other application or use. Buyer shall be solely responsible for determining appropriateness of the particular Product with respect to Buyer's application, product or system. Buyer shall take application responsibility in all cases.

NEVER USE THE PRODUCT FOR AN APPLICATION INVOLVING SERIOUS RISK TO LIFE OR PROPERTY OR IN LARGE QUANTITIES WITHOUT ENSURING THAT THE SYSTEM AS A WHOLE HAS BEEN DESIGNED TO ADDRESS THE RISKS, AND THAT THE OMRON PRODUCT(S) IS PROPERLY RATED AND INSTALLED FOR THE INTENDED USE WITHIN THE OVERALL EQUIPMENT OR SYSTEM.

Programmable Products.

Omron Companies shall not be responsible for the user's programming of a programmable Product, or any consequence thereof.

Performance Data.

Data presented in Omron Company websites, catalogs and other materials is provided as a guide for the user in determining suitability and does not constitute a warranty. It may represent the result of Omron's test conditions, and the user must correlate it to actual application requirements. Actual performance is subject to the Omron's Warranty and Limitations of Liability.

Change in Specifications.

Product specifications and accessories may be changed at any time based on improvements and other reasons. It is our practice to change part numbers when published ratings or features are changed, or when significant construction changes are made. However, some specifications of the Product may be changed without any notice. When in doubt, special part numbers may be assigned to fix or establish key specifications for your application. Please consult with your Omron's representative at any time to confirm actual specifications of purchased Product.

Errors and Omissions.

Information presented by Omron Companies has been checked and is believed to be accurate; however, no responsibility is assumed for clerical, typographical or proofreading errors or omissions.