

Analog Input Unit

CK3W-AD□100

CSM_CK3W-AD_100_DS_E_DITA_4_1

Analog input units for CK3M Controller



CK3W-AD□100

Features

- Voltage input (-10 to 10 V)
- 4 or 8 analog inputs per unit

System Configurations

Basic System Configuration

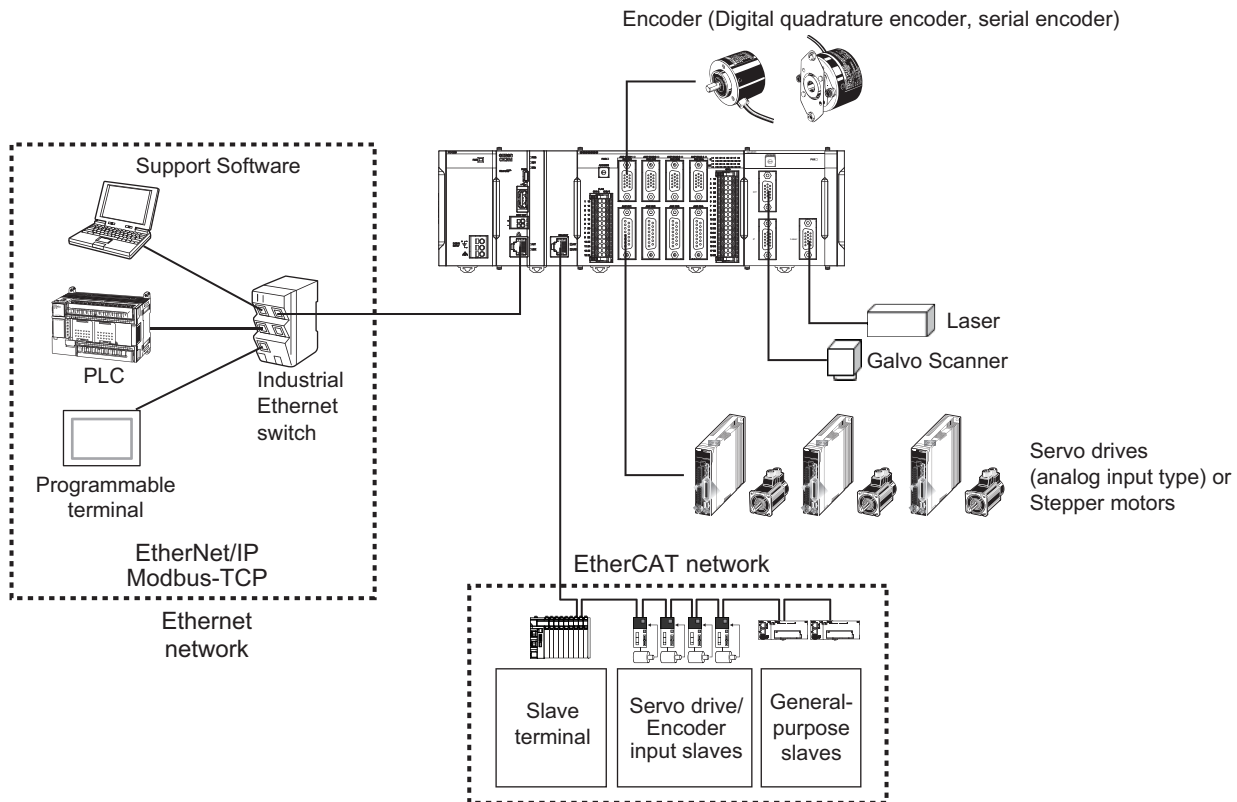

*1. You will need this unit when you use the Galvo Scanner.

CK□W Unit Configuration (CPU Rack/Expansion Rack)

The following shows the configuration of CK□W Units.

CPU Rack

The CK3W Unit configuration in the CPU Rack consists of a Power Supply Unit, CPU Unit, CK3W-AX Unit, CK3W-MD Unit, CK3W-AD Unit, CK3WECS Unit, CK3W-GC Unit, and End Cover.

Up to four CK3W Units (or up to two CK3W-AX Units) can be connected to the CPU Unit.

Expansion Rack

Up to one Expansion Rack can be added for the CK3M CPU Unit, and up to three Expansion Racks can be added for the CK5M CPU Unit. To connect an Expansion Rack, use the Expansion Master Unit (CK3W-EXM01) and Expansion Slave Unit (CK5W-EXS01, CK3W-EXS02). Up to four CK3W Units (or up to two CK3W-AX Units) can be installed to the Expansion Rack.

Connect the Expansion Master Unit (CK3W-EXM01) to the immediate right side of the CPU Unit. Connect the Expansion Slave Unit (CK5W-EXS01, CK3W-EXS02) to the immediate right side of the Power Supply Unit.

Unless the Expansion Master Unit (CK3W-EXM01) is connected adjacent to the right side of the CPU Unit, the Sys.Status register CK3WConfigErr becomes "5".

Use the CK3W-EXS02 for the Expansion Slave Unit farthest from the CPU Rack, and the CK5WEXS01 for the Expansion Slave Unit located in the middle. The CK5W-EXS01 can only be used with the CK5M CPU Unit. It can not be used with the CK3M CPU Unit.

For CK5M CPU Unit

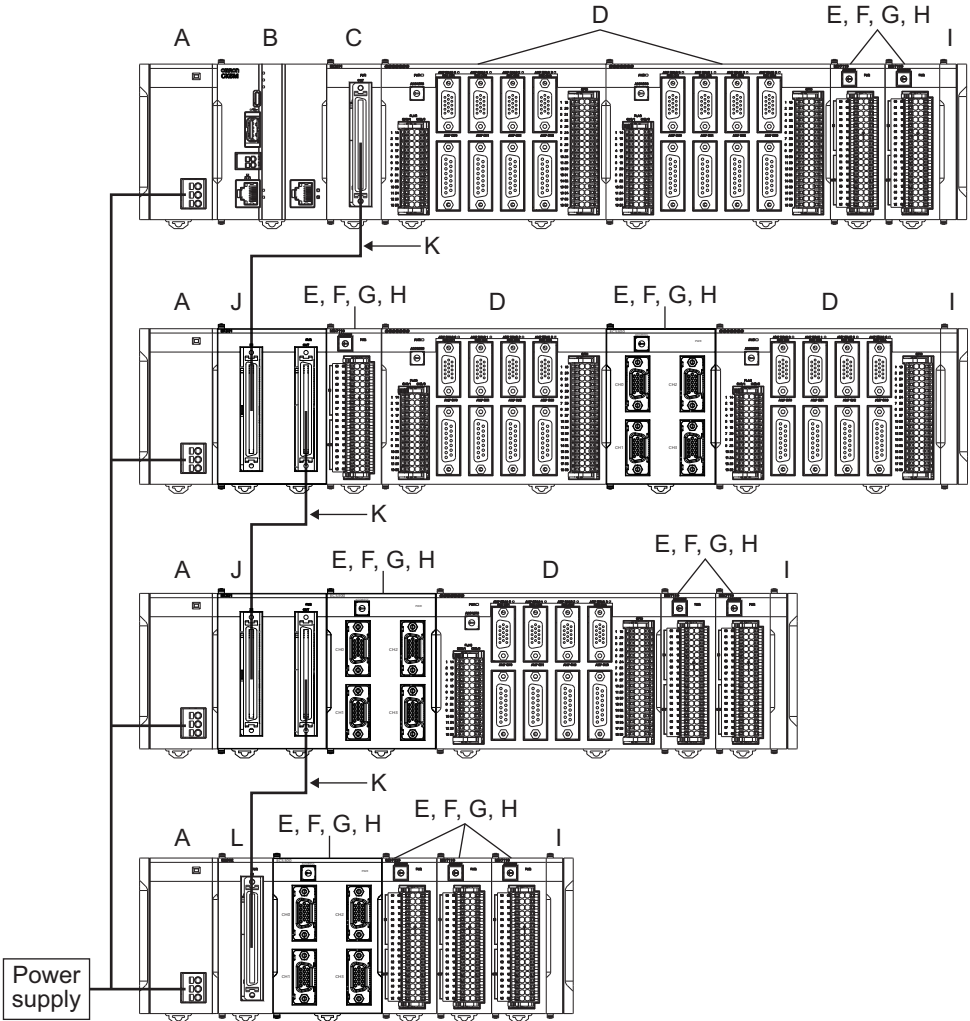

Letter	Configuration	Remarks
A	Power Supply Unit	Input the 24 V power source. Always wire the CPU Rack and Expansion Rack to the same power supply.
B	CK5M-series CPU Unit	This is the Unit at the center of the motion control, which executes the motion program.
C	CK3W-EXM01	Expansion Master Unit. Connect this Unit adjacent to the right side of the CPU Unit in the Expansion Rack.
D	CK3W-AX Unit	Axis Interface Unit. For axis control, connect this to a Servo Drive and encoder.
E	CK3W-MD Unit	Digital I/O Unit. You can add 16 digital inputs and 16 digital outputs.
F	CK3W-AD Unit	Analog Input Unit. You can add 4 or 8 voltage inputs.
G	CK3W-ECS Unit	Encoder Input Unit. You can connect four channels of the serial encoder.
H	CK3W-GC Unit	Laser Interface Unit. You can connect the Galvo Scanner compatible with the interface of XY2-100 or SL2-100.
I	End Cover	Must be connected to the right end of the CPU Rack and Expansion Rack. The CPU Unit and the Expansion Slave Unit are each provided with one End Cover.
J	CK5W-EXS01	Expansion Slave Unit. Use this in the Expansion Rack located in the middle. Connect this Unit to the immediate right side of the Power Supply Unit. This unit can only be used with the CK5M CPU Unit. It can not be used with the CK3M CPU Unit.
K	Expansion cable	Use this cable to connect the Expansion Master Unit and Expansion Slave Unit. The cable length is 30 cm. Be sure to use the CK3W-CAX03A (30 cm) cable.
L	CK3W-EXS02	Expansion Slave Unit. Use this for the Expansion Rack farthest from the CPU Rack. Connect this Unit to the immediate right side of the Power Supply Unit.

For CK3M CPU Unit

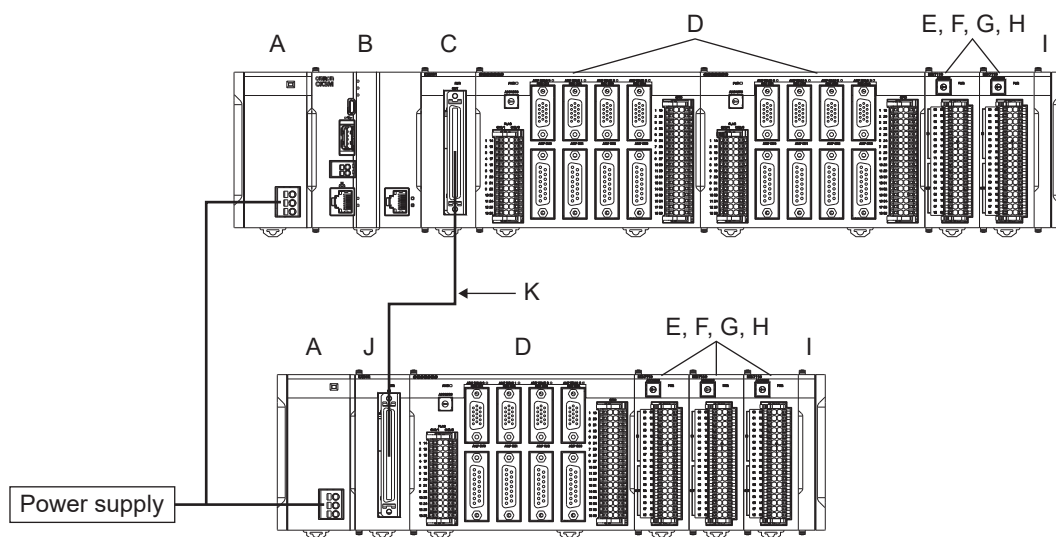

Letter	Configuration	Remarks
A	Power Supply Unit	Input the 24 V power source. Always wire the CPU Rack and Expansion Rack to the same power supply.
B	CK3M-series CPU Unit	This is the Unit at the center of the motion control, which executes the motion program.
C	CK3W-EXM01	Expansion Master Unit. Connect this Unit adjacent to the right side of the CPU Unit in the Expansion Rack.
D	CK3W-AX Unit	Axis Interface Unit. For axis control, connect this to a Servo Drive and encoder.
E	CK3W-MD Unit	Digital I/O Unit. You can add 16 digital inputs and 16 digital outputs.
F	CK3W-AD Unit	Analog Input Unit. You can add 4 or 8 voltage inputs.
G	CK3W-ECS Unit	Encoder Input Unit. You can connect four channels of the serial encoder.
H	CK3W-GC Unit	Laser Interface Unit. You can connect the Galvo Scanner compatible with the interface of XY2-100 or SL2-100.
I	End Cover	Must be connected to the right end of the CPU Rack and Expansion Rack. The CPU Unit and the Expansion Slave Unit are each provided with one End Cover.
J	CK3W-EXS02	Expansion Slave Unit. Use this in the Expansion Rack. Connect this Unit adjacent to the right side of the Power Supply Unit.
K	Expansion cable	Use this cable to connect the Expansion Master Unit and the Expansion Slave Unit. The cable length is 30 cm. Be sure to use the CK3W-CAX003A (30 cm) cable.

EtherCAT Network Configuration

The EtherCAT network configuration consists of a Power Supply Unit, CPU Unit, End Cover, and EtherCAT slaves. Use the built-in EtherCAT port on the CK□M-series CPU Unit to connect EtherCAT slaves.

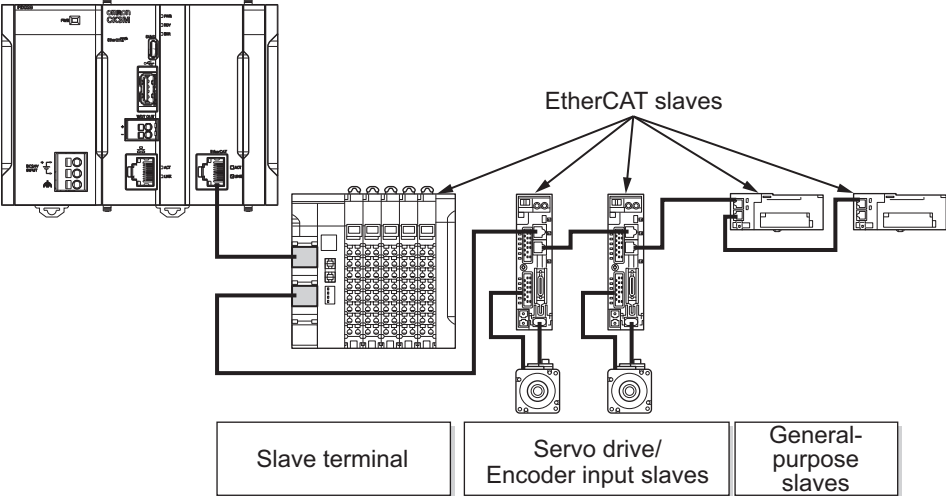

EtherCAT is synchronized with the servo cycle of the CK□M-series CPU Unit. This enables acquisition of the I/O data of slave terminals that are synchronized with the servo cycle. Refer to the *CK3M/CK5M-series Programmable Multi-Axis Controller User's Manual Hardware* (Cat.No.O036) for information on using the NX-series EtherCAT Coupler Unit.

Ordering Information

Analog Input Units

Product name	Input range	Number of inputs	Model
Analog Input Unit	-10 to 10 V	4	CK3W-AD2100
		8	CK3W-AD3100

General Specifications

This section describes the Motion Controller specifications.

Item		Specification
Enclosure		Mounted in a panel
Grounding Method		Ground to less than 100 Ω.
Operating Environment	Ambient Operating Temperature	0 to 55°C
	Ambient Operating Humidity	10% to 95% (with no condensation or icing)
	Atmosphere	Must be free of corrosive gases.
	Ambient Storage Temperature	-25 to 70°C (with no condensation or icing)
	Vibration Resistance	Conforms to IEC 60068-2-6. 5 to 8.4 Hz with 3.5-mm amplitude, 8.4 to 150 Hz, acceleration of 9.8 m/s ² 100 min each in X, Y, and Z directions (10 sweeps of 10 min each = 100 min total)
	Shock Resistance	Conforms to IEC 60068-2-27. 147 m/s ² , 3 times each in X, Y, and Z directions
Insulation Resistance		20 MΩ min. between isolated circuits (at 100 VDC)
Dielectric Strength		510 VAC between isolated circuits for 1 minute with a leakage current of 5 mA max.
Applicable Standards		cULus, EU: EN 61326, RCM, KC, EAC *1

*1. The CK5M CPU Unit and CK5W-EXS01 are not EAC-compliant products.

Specifications

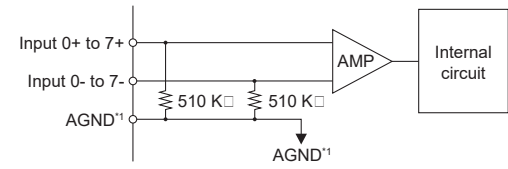
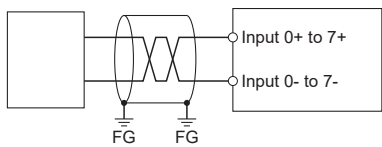
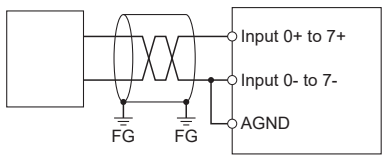
Analog input	Input method	Differential or single-ended input *1
	Input range	-10 to 10 V
	Absolute maximum rating	±12 V (GND reference)
	Input impedance	1 MΩ min.
	Resolution	1/65116 (full scale)
	Accuracy (25°C)	±1.0%FS
	Effect of temperature	±0.018%FS/°C
	Isolation method	Between input and internal circuit: Power supply = Transformer, Signal = Digital isolator (Not isolated between inputs)
	Circuit configuration	 <p>AGND: Analog circuit GND</p>
	Terminal connection diagram	<p>For differential input</p>  <p>For single-ended input</p>  <ul style="list-style-type: none"> • If any of Input 0- to Input 7- is single ended input, apply a short-circuit between the input and AGND. • Use a shielded cable and ground at both ends of the cable.
Power consumption	CK3W-AD3100: 5 V 0.9 W max., 24 V 2.0 W max. CK3W-AD2100: 5 V 0.9 W max., 24 V 1.4 W max.	
Dimensions (height × depth × width)	90(H)/80(D)/31.6(W)	
Weight	CK3W-AD3100: 140 g max. CK3W-AD2100: 120 g max.	

*1. Differential input and single-ended input can be mixed in a Unit.

Part Names and Functions

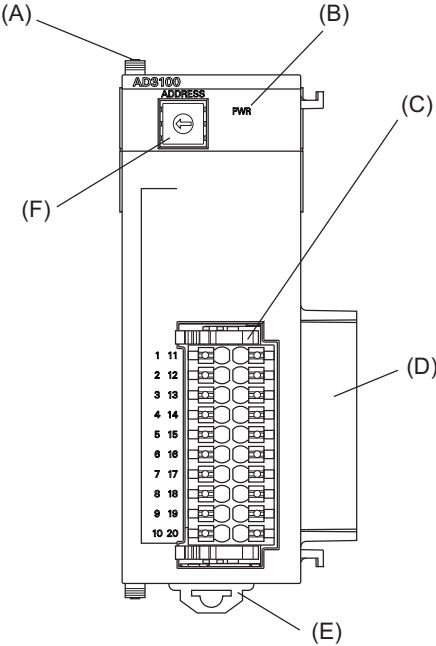

Letter	Name	Function
A	Slider	Holds the Units together.
B	Power supply status indicator	Shows the power supply status.
C	Terminal block	Connects the analog input.
D	Unit connector	Connector that connects to the Unit.
E	DIN Track mounting hook	Used to mount the Unit to a DIN Track.
F	Address switch	Sets the Gate3 Index.

Wiring

Applicable Wires

The wires that you can connect to the terminal block are twisted wires, solid wires, and ferrules that are attached to the twisted wires. The following section describes the dimensions and processing methods for applicable wires.

Using Ferrules

If you use ferrules, attach the twisted wires to them.
 Observe the application instructions for your ferrules for the wire stripping length when attaching ferrules.
 Always use plated one-pin ferrules. Do not use unplated ferrules or two-pin ferrules.

The applicable ferrules, wires, and crimping tools are listed in the following table.

Manufacturer	Ferrule model	Applicable wire (mm ² (AWG))	Crimping Tool (applicable wire size given in parentheses)
Phoenix Contact	AI0,5-10	0.5 (#20)	Phoenix Contact CRIMPFOX 6 (0.25 to 6 mm ² , AWG24 to 10)
	AI0,75-10	0.75 (#18)	
	AI1,0-10	1.0 (#18)	
	AI1,5-10	1.5 (#16)	
Weidmüller	H0.5/16	0.5 (#20)	Weidmüller PZ6 Roto (0.14 to 6 mm ² , AWG26 to 10)
	H0.75/16	0.75 (#18)	
	H1.0/16	1.0 (#18)	
	H1.5/16	1.5 (#16)	

Using Twisted or Solid Wires

Wire type	Conductor cross-sectional area	Conductor length (stripping length)
Solid wire	0.14 to 1.5 mm ²	10 mm
Twisted wire		

Required Tools

Use a flat-blade screwdriver to remove wires.
 The recommended screwdriver is as follows.

Model	Manufacturer
SZF 0-0,4X2,5	Phoenix Contact

Dimensions

(Unit: mm)

Analog Input Unit

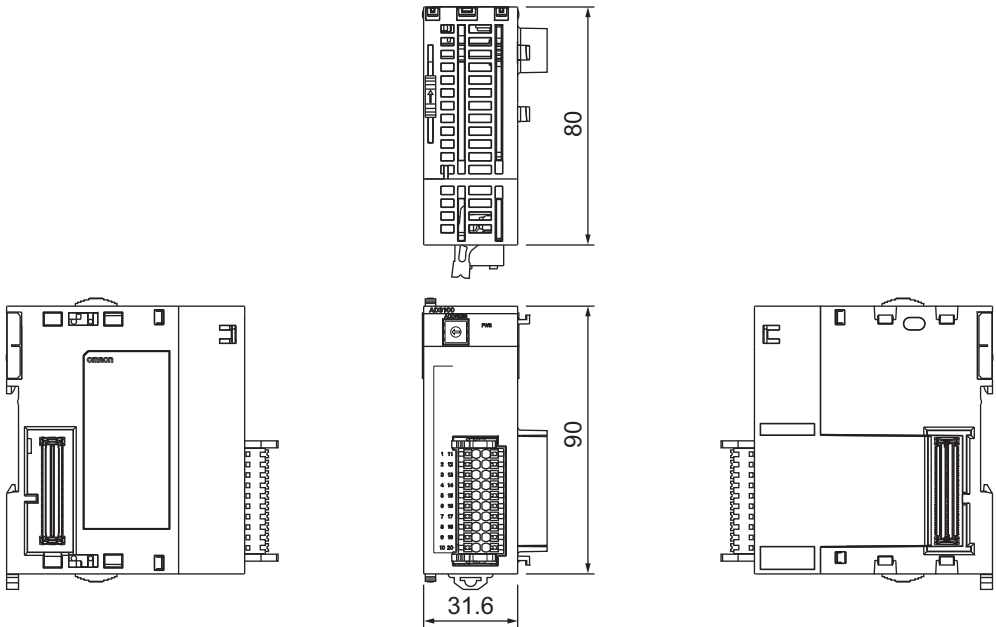

Related Manuals

The following manuals are related. Use these manuals for reference. Contact your OMRON representative for information on how to procure these manuals.

Manual name	Cat. No.	Application	Description
CK3M/CK5M-series Programmable Multi-Axis Controller Hardware User's Manual	O036	Learning the basic specifications of the CK3M/CK5M-series Programmable Multi-Axis Controller, including introductory information, design, installation, and maintenance. Mainly hardware information is provided.	An introduction to the entire CK3M/CK5M-series system is provided along with the following information. <ul style="list-style-type: none"> • Features and system configuration • Introduction • Part names and functions • General specifications • Installation and wiring • Maintenance and inspection
Power PMAC User's Manual	O014	Learning the features and usage examples of the Motion Controller.	The following information is provided on the Motion Controller. <ul style="list-style-type: none"> • Basic functions • Setup examples • Programming examples
Power PMAC Software Reference Manual	O015	Learning how to program Motion Controller.	The following information is provided on the Motion Controller. <ul style="list-style-type: none"> • Details of commands • Details of data structure
Power PMAC IDE User Manual	O016	Learning how to operate Power PMAC IDE, the integrated development environment of the Controller.	Describes the operating procedures of Power PMAC IDE, and examples of how to start the system.
Power PMAC-NC Quick Start Manual	O017	Briefly understanding the basic usage of Power PMAC-NC.	Describes the Quick setup procedure to run Power PMAC-NC on a desktop PC by showing some examples.
Power PMAC-NC .ini Configuration Manual	O018	Configuring an application for CNC devices by using Power PMAC-NC.	Describes how to set up <i>PowerPmacNC.ini</i> , the setup data file to be loaded when Power PMAC-NC starts.
Power PMAC-NC Software User Manual	O019	Learning about usage and features of Power PMAC-NC, Support Software required to use the Controller for CNC devices.	The following information is provided on Power PMAC-NC. <ul style="list-style-type: none"> • How to use the software • Features included in the software • Features that can be customized
Power PMAC-NC Mill G-Code Manual	O020	Creating programs for CNC devices by using Power PMAC-NC.	Describes the basic G-code set that can be used for Power PMAC-NC, and relevant instructions.

EtherCAT® is a registered trademark and patented technology, licensed by Beckhoff Automation GmbH, Germany.

EtherNet/IP™ is trademarks of ODVA.

Other company names and product names in this document are the trademarks or registered trademarks of their respective companies.

The product photographs and figures that are used in this catalog may vary somewhat from the actual products.

PMAC is an abbreviation for Programmable Multi Axis Controller.

Terms and Conditions Agreement

Read and understand this catalog.

Please read and understand this catalog before purchasing the products. Please consult your OMRON representative if you have any questions or comments.

Warranties.

(a) Exclusive Warranty. Omron's exclusive warranty is that the Products will be free from defects in materials and workmanship for a period of twelve months from the date of sale by Omron (or such other period expressed in writing by Omron). Omron disclaims all other warranties, express or implied.

(b) Limitations. OMRON MAKES NO WARRANTY OR REPRESENTATION, EXPRESS OR IMPLIED, ABOUT NON-INFRINGEMENT, MERCHANTABILITY OR FITNESS FOR A PARTICULAR PURPOSE OF THE PRODUCTS. BUYER ACKNOWLEDGES THAT IT ALONE HAS DETERMINED THAT THE PRODUCTS WILL SUITABLY MEET THE REQUIREMENTS OF THEIR INTENDED USE.

Omron further disclaims all warranties and responsibility of any type for claims or expenses based on infringement by the Products or otherwise of any intellectual property right. (c) Buyer Remedy. Omron's sole obligation hereunder shall be, at Omron's election, to (i) replace (in the form originally shipped with Buyer responsible for labor charges for removal or replacement thereof) the non-complying Product, (ii) repair the non-complying Product, or (iii) repay or credit Buyer an amount equal to the purchase price of the non-complying Product; provided that in no event shall Omron be responsible for warranty, repair, indemnity or any other claims or expenses regarding the Products unless Omron's analysis confirms that the Products were properly handled, stored, installed and maintained and not subject to contamination, abuse, misuse or inappropriate modification. Return of any Products by Buyer must be approved in writing by Omron before shipment. Omron Companies shall not be liable for the suitability or unsuitability or the results from the use of Products in combination with any electrical or electronic components, circuits, system assemblies or any other materials or substances or environments. Any advice, recommendations or information given orally or in writing, are not to be construed as an amendment or addition to the above warranty.

See <http://www.omron.com/global/> or contact your Omron representative for published information.

Limitation on Liability: Etc.

OMRON COMPANIES SHALL NOT BE LIABLE FOR SPECIAL, INDIRECT, INCIDENTAL, OR CONSEQUENTIAL DAMAGES, LOSS OF PROFITS OR PRODUCTION OR COMMERCIAL LOSS IN ANY WAY CONNECTED WITH THE PRODUCTS, WHETHER SUCH CLAIM IS BASED IN CONTRACT, WARRANTY, NEGLIGENCE OR STRICT LIABILITY.

Further, in no event shall liability of Omron Companies exceed the individual price of the Product on which liability is asserted.

Suitability of Use.

Omron Companies shall not be responsible for conformity with any standards, codes or regulations which apply to the combination of the Product in the Buyer's application or use of the Product. At Buyer's request, Omron will provide applicable third party certification documents identifying ratings and limitations of use which apply to the Product. This information by itself is not sufficient for a complete determination of the suitability of the Product in combination with the end product, machine, system, or other application or use. Buyer shall be solely responsible for determining appropriateness of the particular Product with respect to Buyer's application, product or system. Buyer shall take application responsibility in all cases.

NEVER USE THE PRODUCT FOR AN APPLICATION INVOLVING SERIOUS RISK TO LIFE OR PROPERTY OR IN LARGE QUANTITIES WITHOUT ENSURING THAT THE SYSTEM AS A WHOLE HAS BEEN DESIGNED TO ADDRESS THE RISKS, AND THAT THE OMRON PRODUCT(S) IS PROPERLY RATED AND INSTALLED FOR THE INTENDED USE WITHIN THE OVERALL EQUIPMENT OR SYSTEM.

Programmable Products.

Omron Companies shall not be responsible for the user's programming of a programmable Product, or any consequence thereof.

Performance Data.

Data presented in Omron Company websites, catalogs and other materials is provided as a guide for the user in determining suitability and does not constitute a warranty. It may represent the result of Omron's test conditions, and the user must correlate it to actual application requirements. Actual performance is subject to the Omron's Warranty and Limitations of Liability.

Change in Specifications.

Product specifications and accessories may be changed at any time based on improvements and other reasons. It is our practice to change part numbers when published ratings or features are changed, or when significant construction changes are made. However, some specifications of the Product may be changed without any notice. When in doubt, special part numbers may be assigned to fix or establish key specifications for your application. Please consult with your Omron's representative at any time to confirm actual specifications of purchased Product.

Errors and Omissions.

Information presented by Omron Companies has been checked and is believed to be accurate; however, no responsibility is assumed for clerical, typographical or proofreading errors or omissions.

2023.1

In the interest of product improvement, specifications are subject to change without notice.

OMRON Corporation
Industrial Automation Company

<http://www.ia.omron.com/>

(c)Copyright OMRON Corporation 2023 All Right Reserved.