

CS-series EtherNet/IP Unit

CS1W-EIP21/EIP21S

CSM_CS1W-EIP21_EIP21S_DS_E_7_7

EtherNet/IP unit with tag data link capacity of 180,000 words or more

- EtherNet/IP is an industrial multivendor network that uses Ethernet. Managed by the ODVA (Open DeviceNet Vendors Association), it has open standards and is used with a wide range of industrial devices.
- The EtherNet/IP Unit supports tag data links to enable sharing data between devices at Ethernet nodes and a message service for sending and receiving data when required.
- The EtherNet/IP Unit supports the same FINS/UDP, FINS/TCP and Socket service functionality as Ethernet Units.
- Various security functions enable secure network connections. (CS1W-EIP21S)



EtherNet/IP™

Features

- Large-capacity tag data links are easily enabled by simply setting connections, with no programming required.
- Tag data links can be used to exchange data with up to 256 nodes over up to 256 connections.
- Up to 256 connections can be set per Unit with up to 722 words of data per connection, for a total of up to 184,832 words of link data. (There is no limit to the data link capacity for the overall network.)
- Data concurrency is maintained within each connection (for up to 722 words).
- Tag data link settings can be changed for individual Units even while tag data links are being used on a network.
- Errors can be diagnosed using the Network Configurator, and system errors can be monitored with a wide array of status flags.
- A secure network connection can be realized with Secure Communications, User Authentication, Opening and Closing the port, IP Packet filtering. (CS1W-EIP21S)

System Configuration

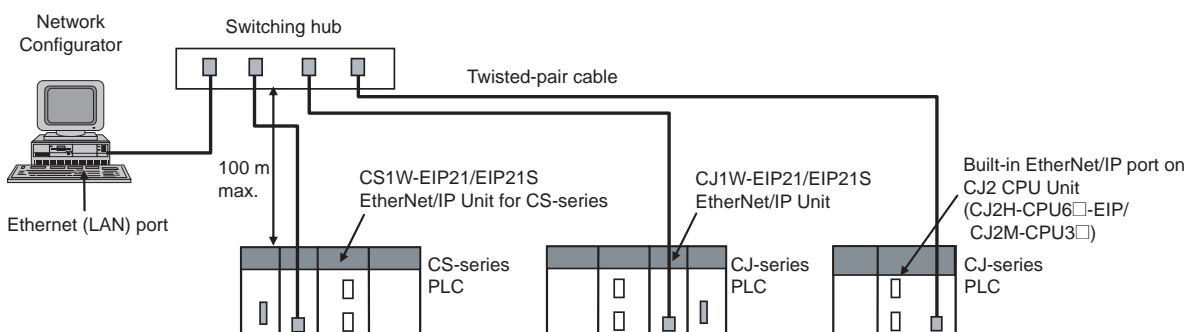

Windows are either registered trademarks or trademarks of Microsoft Corporation in the United States and/or other countries. EtherNet/IP™, DeviceNet™ and CompoNet™ are trademarks of the ODVA. Other company names and product names are the trademarks or registered trademarks of their respective companies.

CS1W-EIP21/EIP21S

Ordering Information

International Standards

- The standards are abbreviated as follows: U: UL, U1: UL (Class I Division 2 Products for Hazardous Locations), C: CSA, UC: cULus, UC1: cULus (Class I Division 2 Products for Hazardous Locations), CU: cUL, N: NK, L: Lloyd, and CE: EC Directives.
- Contact your OMRON representative for further details and applicable conditions for these standards.
- Refer to the OMRON website (www.ia.omron.com) or ask your OMRON representative for the most recent applicable standards for each model.

EtherNet/IP Unit

Unit type	Product name	Specifications			No. of unit numbers allocated	Current consumption (A)		Model	Standards
		Communications cable	Communications functions	Units per CPU Unit		5 V system	26 V system		
CS1 CPU Bus Unit	 EtherNet/IP Unit	Shielded twisted-pair (STP) cable Categories: 100 Ω at 5, 5e	Tag Data Link Functions, Message Communications Functions	8 max.	1	0.41	-	CS1W-EIP21	UC1, N, L, CE
			Tag Data Link Functions, Message Communications Functions, Socket Service Functions			0.62		CS1W-EIP21S NEW	

Industrial Switching Hubs

Product name	Appearance	Functions	No. of ports	Accessories	Current consumption (A)	Model
Industrial Switching Hubs		Quality of Service (QoS): EtherNet/IP control data priority 10/100BASE-TX, Auto-Negotiation	5	Power supply connector	0.07	W4S1-05D

Recommended Network Devices

The following table shows the devices recommended for use with the EtherNet/IP.

Part	Manufacturer	Model number	Inquires
Switching Hub	Phoenix Contact	FL SWITCH SFN 8TX (8 ports)	Phoenix Contact USA Customer Service
	Contec USA, Inc.	SH8008(FIT)H (8 ports)	CONTEC USA Inc.
	Cisco Systems, Inc.	WS-C2955T-12 (12 ports)	Cisco Systems, Inc. Main Corporate HQ
Twisted-pair cable	100BASE-TX EtherNet/IP compliant cable		-
	STP Plug		
Connectors (Modular plug)	Panduit Corporation	MPS588	Panduit Corporation US Headquarters
	Tsuko Company	MK boot (IV) LB	Tsuko Company Japan Headquarters

Note: 1. Always use a switching hub when using tag data links in the network.

Note: 2. If a repeater hub is used for EtherNet/IP tag data links (cyclic communications), the network's communications load will increase, data collisions will occur frequently, and stable communications will be impossible.

Mountable Racks

Model	CS1 System				CS1D System						
	CPU Rack		Expansion Backplane (including Long-distance Expansion Rack)		SYSBUS Remote I/O Slave Rack	C200HX/HG/HE Expansion I/O Rack	CPU Rack			Expansion Backplane	
	CS1W-BC		CS1W-BI				CS1D-BC			CS1D-BI	
	□□3	□□2	□□3	□□2	052	042D	082S	092	082D		
CS1W-EIP21/EIP21S	8 Units (per CPU Unit)				Not supported	Not supported	8 Units (per CPU Unit)				

EtherNet/IP Unit Specifications

Item		Specifications
Model number		CS1W-EIP21/EIP21S
Type		100Base-TX *1
Applicable PLCs		CS-series PLCs *2
Unit classification		CS-series CPU Bus Unit
Mounting location		CPU Rack or Expansion Rack
Number of Units that can be mounted		8 max. (including Expansion Racks)
CPU Unit words used	Allocated CIO Area words (CPU Bus Unit words)	25 words/Unit (one unit number's words) These words contain control bits and flags, the target node PLC's operating and error information, Unit status, communications status, registered/normal target node information, and FINS/TCP connection status.
	Allocated DM Area words (CPU Bus Unit words)	100 words/Unit (one unit number's words) These words contain the IP address display/setting area
	User-set area	Any usable data area words Target node PLC's operating and error information, and registered/normal target node information
	CPU Bus Unit System Setup	Not used.
Non-volatile memory within EtherNet/IP Unit (See note.)		The following settings are stored in the EtherNet/IP Unit's non-volatile memory. Note: Unlike the regular Ethernet Units, the CPU Bus Unit Setup Area in the CPU Unit is not used for these settings. 1. Unit setup (communications settings for the EtherNet/IP Unit, such as the IP address, DNS server settings, host name, baud rate, FINS/UDP settings, and FINS/TCP settings) 2. Tag data link settings (device parameters) 3. User authentication settings (CS1W-EIP21S only) 4. Operation log (CS1W-EIP21S only)
Transfer specifications	Media access method	CSMA/CD
	Modulation method	Baseband
	Transmission paths	Star form
	Baud rate	100 Mbit/s (100Base-TX)
	Transmission media	Shielded twisted-pair (STP) cable Categories: 100 Ω at 5, 5e
	Transmission distance	100 m (distance between hub and node)
	Number of cascade connections	There is no limitation when a switching hub is used.
Current consumption (Unit)		CS1W-EIP21: 410 mA max. at 5 V DC CS1W-EIP21S: 620 mA max. at 5 V DC
Weight		CS1W-EIP21: 171 g max. CS1W-EIP21S: 180 g max.
Dimensions		35 × 130 × 101 mm (W × H × D)
Other general specifications		Other specifications conform to the general specifications of the CS-series

*1. If tag data links are being used, use 100Base-TX. Otherwise, 10Base-T can be used, but this is not recommended.

*2. For the CS1W-EIP21S, the following CPU Units are supported.

CS1G-CPU□□H, CS1H-CPU□□H, CS1D-CPU□□HA/H, CS1D-CPU□□SA/S, and CS1D-CPU□□P

CS1W-EIP21/EIP21S

Communications Specifications

Item		Specifications	
CIP service	Tag data links (Cyclic communications)	Number of connections	256
		Packet interval (refresh cycle)	0.5 to 10,000 ms (in 0.5-ms units) Can be set independently for each connection. (Data is refreshed over the network at the preset interval and does not depend on the number of nodes.)
		Allowed communications bandwidth per Unit	6,000 to 12,000 pps *1 *2 Note: Including the heartbeat.
		Number of tag sets	256
		Tag types	CIO Area, DM Area, EM Area, Holding Area, and Work Area
		Number of tags per connection (= 1 tag set)	8 (7 tags when the tag set contains the PLC status)
		Maximum link data size per node (total size of all tags)	184,832 words
		Maximum data size per connection	252 words or 722 words *3 Note: Data synchronicity is maintained within each connection.
		Number of registrable tag sets	256 (1 connection = 1 tag set)
		Maximum size of 1 tag set	722 words (The PLC status uses 1 word when the tag set contains the PLC status.)
		Maximum number of tags that can be refreshed per CPU Unit cycle *4	Output/Transmission (CPU to EtherNet/IP): 19 Input/Reception (EtherNet/IP to CPU): 20 *5
		Data that can be refreshed per CPU Unit cycle *4 The layout of the allocated CIO Area words is the default *6	Output/Transmission (CPU to EtherNet/IP): 7,469 words Input/Reception (EtherNet/IP to CPU): 7,469 words
		Changing tag data link parameters during operation	Supported *7
	Multicast packet filter function *8	Supported	
	Explicit messaging	Class 3 (connected)	Number of connections: 128
UCMM (unconnected)		Number of clients that can communicate at one time: 32 max. Number of servers that can communicate at one time: 32 max.	
CIP routing		CS1W-EIP21/EIP21S, CJ1W-EIP21/EIP21S, CJ2H-CPU6□-EIP, CJ2M-CPU3□	
FINS service *9	FINS/UDP	Supported	
	FINS/TCP	16 connections max.	
SNMP	Agent	SNMPv1, SNMPv2c, SNMP trap	
	MIB	MIB-II	
EtherNet/IP conformance test		CS1W-EIP21S: CT17 CS1W-EIP21: CT11	
Ethernet interface		10BASE-T or 100BASE-TX Auto Negotiation or fixed settings	

*1. In this case, pps means "packets per second" and indicates the number of packets that can be processed in one second.

*2. When using CS1W-EIP21S or CS1W-EIP21 with version 3.0 or later.

When using CS1W-EIP21 with version 2.1 or earlier, the allowed communications bandwidth per Unit is 6,000 pps.

*3. To use 505 to 1,444 bytes as the data size, the system must support the Large Forward Open standard (an optional CIP specification). The CS/CJ-series Units support this standard, but before connecting to nodes of other companies, confirm that those devices also support it.

*4. If the maximum data size is exceeded, the data refreshing with the CPU Unit will extend over two or more cycles.

*5. If status layout is set to user settings, the maximum number of tags is as follows.

Condition	Output/Transmission	Input/Reception
CS1W-EIP21S	18	18
CS1W-EIP21	19	19

*6. The table below shows value when the layout type is User defined.

Data (words) that can be refreshed per CPU Unit cycle	EIP21		EIP21S
	Output/Transmission	Input/Reception	
	7405	7405	7321
			7385

*7. If parameters are changed in the EtherNet/IP Unit, however, the EtherNet/IP Unit will be restarted. When other nodes are communicating with the affected node, the communications will temporarily time out and automatically recover later.

*8. Because the EtherNet/IP Unit is equipped with an IGMP client, unnecessary multicast packets can be filtered by using a switching hub that supports IGMP snooping.

*9. The EtherNet/IP Unit uses the TCP/UDP port numbers shown in the following table.

Service	Protocol	Port number	Remarks
Tag data links	UDP	2222	The port number is fixed.
Class 3, UCMM	TCP/UDP	44818	
DNS	UDP	53	
Secure Comm	TCP	443	The port number is fixed. It is supported by the CS1W-EIP21S only.
FINS/UDP service	UDP	9600	Port numbers in the Unit Setup can be changed with the CX-Programmer.
FINS/TCP service	TCP	9600	
FTP	TCP	20, 21	
SNTP	UDP	123	
SNMP	UDP	161	
SNMP trap	UDP	162	

Network Configurator Requirements

The Network Configurator is a software package designed for building, setting, and controlling a multi-vendor EtherNet/IP Network using OMRON's EtherNet/IP. It is included in CX-One.

CS1W-EIP21 EtherNet/IP Unit. Network Configurator version 3.0 or higher is included with CX-One version 3.0 or higher.

CS1W-EIP21S EtherNet/IP Unit. Network Configurator version 3.73 or higher is included with CX-One version 4.61 or higher.

The Network Configurator provides the following functions for building, setting, and controlling EtherNet/IP.

Item	Specification
System Requirements	Refer to the CX-One Catalog (Cat. No. R134), visit your local OMRON website.
Network connection method	CS1/CJ1
	CJ2
Serial interface	CPU Unit's Peripheral or RS-232C port
Ethernet interface	CPU Unit's Ethernet port EtherNet/IP Unit's Ethernet port
Location on Network	A single node address is used (only when directly connected to EtherNet/IP).
Number of Units that can be connected to Network	A single Network Configurator per Network (More than one Configurator cannot be used in the same system.)
Main functions	Network control functions
	Configuration functions
Supported file formats	<ul style="list-style-type: none"> The Network configuration can be created and edited regardless of whether the Network Configurator is online or offline. The Network configuration can be read from a file or the network. The EDS files used by the Network Configurator can be installed and deleted.
	Configurator network configuration files (*.ncf) Configuration files (*.ncf) created using the Network Configurator for EtherNet/IP (version 2) can be imported by selecting External Data - Import from the File Menu.

External Interface

CS1W-EIP21/EIP21S

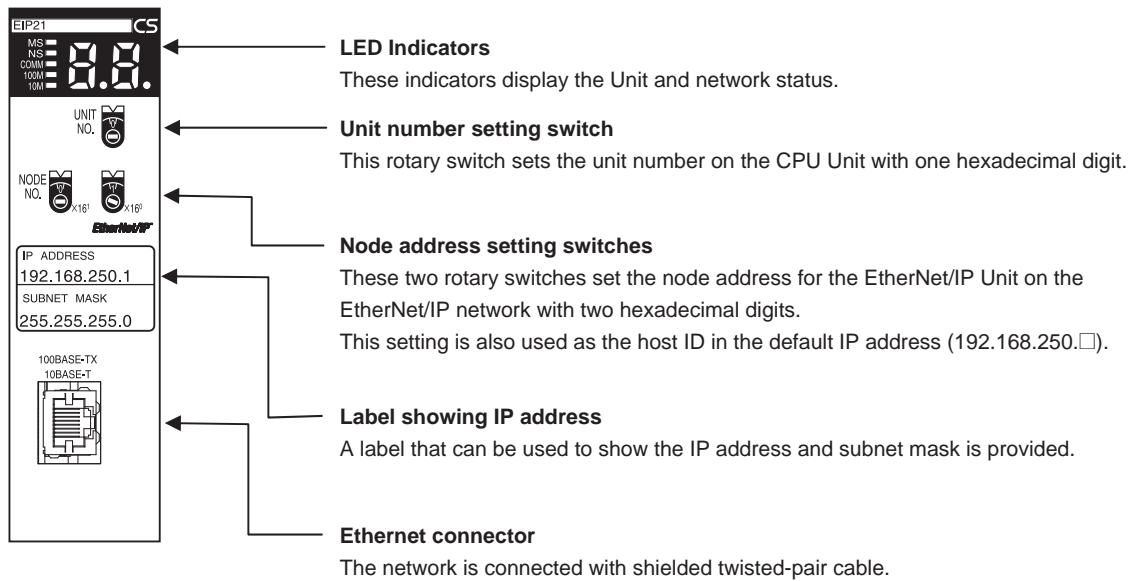

Ethernet Connectors

The following standards and specifications apply to the connectors for the Ethernet twisted-pair cable.

- Electrical specifications: Conforming to IEEE802.3 standards.
- Connector structure: RJ45 8-pin Modular Connector (conforming to ISO 8877)

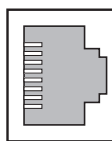

Connector pin	Signal name	Abbr.	Signal direction
1	Transmission data +	TD+	Output
2	Transmission data -	TD-	Output
3	Reception data +	RD+	Input
4	Not used.	-	-
5	Not used.	-	-
6	Reception data -	RD-	Input
7	Not used.	-	-
8	Not used.	-	-
Hood	Frame ground	FG	-

CS1W-EIP21/EIP21S

Ethernet Unit Function Comparison

Item	Support for function			
	Ethernet Unit	CS1W-EIP21S EtherNet/IP Unit	CS1W-EIP21 EtherNet/IP Unit or built-in EtherNet/IP port	
			Unit version 1.0	Unit version 2.0
Tag data link communications service	No	Yes	Yes	Yes
CIP message communications service	No	Yes	Yes	Yes
FINS/UDP service	Yes	Yes	Yes	Yes
FINS/TCP service	Yes	Yes	Yes	Yes
Socket service	Yes	Yes	No	No
File transfer (FTP)	Yes	Yes	No	Yes
Mail send/receive	Yes	No	No	No
Web functions	Yes	No	No	No
Automatic adjustment of PLC's internal clock	Yes	Yes	No	Yes
Simple backup function	Yes	Yes	Yes	Yes
Error log	Yes	Yes	Yes	Yes
Response to PING command	Yes	Yes	Yes	Yes
SNMP/SNMP trap	No	Yes	No	Yes
CIDR function for IP addresses	No	Yes	No	Yes
Online connection by EtherNet/IP using CX-One	No	Yes	No	Yes
Online connection by Ethernet (FINS) using CX-One	Yes	Yes	Yes	Yes
Online connection by EtherNet/IP using Network Configurator	No	Yes	Yes	Yes
Secure communications	No	Yes	No	No
User authentication	No	Yes	No	No
Opening and closing the port	No	Yes	No	No
IP packet filtering	No	Yes	No	No
Operation log	No	Yes	No	No

Dimensions

(Unit: mm)

CS1W-EIP21/EIP21S

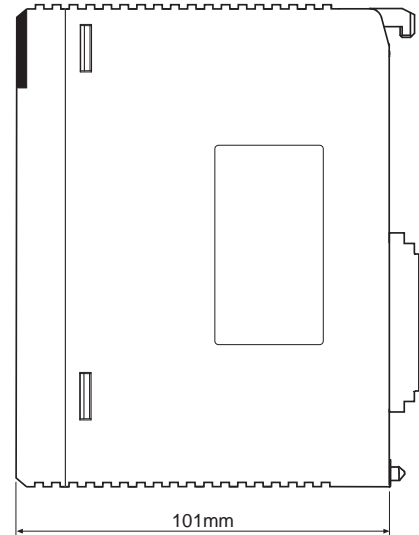
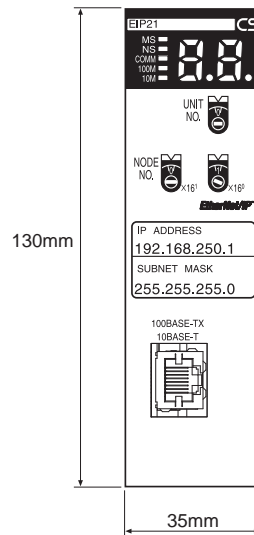

Related Manuals

Manual number	Model	Name	Contents
W465	CS1W-EIP21 CJ1W-EIP21 CJ2H-CPU□□-EIP CJ2M-CPU3□ CS1W-EIP21S CJ1W-EIP21S	EtherNet/IP Units Operation Manual	Provides information on operating and installing EtherNet/IP Units, including details on basic settings, tag data links, and FINS communications. Refer to the <i>Communications Commands Reference Manual</i> (W342) for details on FINS commands that can be sent to CS-series and CJ-series CPU Units when using the FINS communications service. Refer to the <i>Ethernet Units Operation Manual Construction of Applications</i> (W421) for details on constructing host applications that use FINS communications.
W421	CS1W-ETN21 CJ1W-ETN21	Ethernet Units Operation Manual Construction of Applications	Provides information on constructing host applications for 100Base-TX Ethernet Units, including functions for sending/receiving mail, socket service, automatic clock adjustment, FTP server functions, and FINS communications.
W342	CS1G/H-CPU□□H CS1G/H-CPU-□□V1 CS1W-SCU21 CS1W-SCB21/41 CJ1G/H-CPU□□H CJ1G-CPU□□ CJ1W-SCU41	Communications Commands Reference Manual	Describes the C-series (Host Link) and FINS communications commands used when sending communications commands to CS-series and CJ-series CPU Units.
W463	CXONE-AL□□D-V□	CX-One Setup Manual	Describes the setup procedures for the CX-One. Information is also provided on the operating environment for the CX-One.

Terms and Conditions Agreement

Read and understand this catalog.

Please read and understand this catalog before purchasing the products. Please consult your OMRON representative if you have any questions or comments.

Warranties.

(a) Exclusive Warranty. Omron's exclusive warranty is that the Products will be free from defects in materials and workmanship for a period of twelve months from the date of sale by Omron (or such other period expressed in writing by Omron). Omron disclaims all other warranties, express or implied.

(b) Limitations. OMRON MAKES NO WARRANTY OR REPRESENTATION, EXPRESS OR IMPLIED, ABOUT NON-INFRINGEMENT, MERCHANTABILITY OR FITNESS FOR A PARTICULAR PURPOSE OF THE PRODUCTS. BUYER ACKNOWLEDGES THAT IT ALONE HAS DETERMINED THAT THE PRODUCTS WILL SUITABLY MEET THE REQUIREMENTS OF THEIR INTENDED USE.

Omron further disclaims all warranties and responsibility of any type for claims or expenses based on infringement by the Products or otherwise of any intellectual property right. (c) Buyer Remedy. Omron's sole obligation hereunder shall be, at Omron's election, to (i) replace (in the form originally shipped with Buyer responsible for labor charges for removal or replacement thereof) the non-complying Product, (ii) repair the non-complying Product, or (iii) repay or credit Buyer an amount equal to the purchase price of the non-complying Product; provided that in no event shall Omron be responsible for warranty, repair, indemnity or any other claims or expenses regarding the Products unless Omron's analysis confirms that the Products were properly handled, stored, installed and maintained and not subject to contamination, abuse, misuse or inappropriate modification. Return of any Products by Buyer must be approved in writing by Omron before shipment. Omron Companies shall not be liable for the suitability or unsuitability or the results from the use of Products in combination with any electrical or electronic components, circuits, system assemblies or any other materials or substances or environments. Any advice, recommendations or information given orally or in writing, are not to be construed as an amendment or addition to the above warranty.

See <http://www.omron.com/global/> or contact your Omron representative for published information.

Limitation on Liability: Etc.

OMRON COMPANIES SHALL NOT BE LIABLE FOR SPECIAL, INDIRECT, INCIDENTAL, OR CONSEQUENTIAL DAMAGES, LOSS OF PROFITS OR PRODUCTION OR COMMERCIAL LOSS IN ANY WAY CONNECTED WITH THE PRODUCTS, WHETHER SUCH CLAIM IS BASED IN CONTRACT, WARRANTY, NEGLIGENCE OR STRICT LIABILITY.

Further, in no event shall liability of Omron Companies exceed the individual price of the Product on which liability is asserted.

Suitability of Use.

Omron Companies shall not be responsible for conformity with any standards, codes or regulations which apply to the combination of the Product in the Buyer's application or use of the Product. At Buyer's request, Omron will provide applicable third party certification documents identifying ratings and limitations of use which apply to the Product. This information by itself is not sufficient for a complete determination of the suitability of the Product in combination with the end product, machine, system, or other application or use. Buyer shall be solely responsible for determining appropriateness of the particular Product with respect to Buyer's application, product or system. Buyer shall take application responsibility in all cases.

NEVER USE THE PRODUCT FOR AN APPLICATION INVOLVING SERIOUS RISK TO LIFE OR PROPERTY OR IN LARGE QUANTITIES WITHOUT ENSURING THAT THE SYSTEM AS A WHOLE HAS BEEN DESIGNED TO ADDRESS THE RISKS, AND THAT THE OMRON PRODUCT(S) IS PROPERLY RATED AND INSTALLED FOR THE INTENDED USE WITHIN THE OVERALL EQUIPMENT OR SYSTEM.

Programmable Products.

Omron Companies shall not be responsible for the user's programming of a programmable Product, or any consequence thereof.

Performance Data.

Data presented in Omron Company websites, catalogs and other materials is provided as a guide for the user in determining suitability and does not constitute a warranty. It may represent the result of Omron's test conditions, and the user must correlate it to actual application requirements. Actual performance is subject to the Omron's Warranty and Limitations of Liability.

Change in Specifications.

Product specifications and accessories may be changed at any time based on improvements and other reasons. It is our practice to change part numbers when published ratings or features are changed, or when significant construction changes are made. However, some specifications of the Product may be changed without any notice. When in doubt, special part numbers may be assigned to fix or establish key specifications for your application. Please consult with your Omron's representative at any time to confirm actual specifications of purchased Product.

Errors and Omissions.

Information presented by Omron Companies has been checked and is believed to be accurate; however, no responsibility is assumed for clerical, typographical or proofreading errors or omissions.