

## Introduction

### What Is a Level Controller?

A Conductive Level Controller electrically detects the level of a liquid. Conductive Level Controllers (61F) are electronic liquid level detectors used in a wide range of applications such as water and sewer services for office and apartment buildings, industrial applications for iron and steel, food, chemical, pharmaceutical, and semiconductor industries, and liquid level control for agricultural water, water treatment plants, and wastewater plants. When the electrodes are in contact with liquid, the circuit is closed (the liquid completes the path for electricity to flow) and the electrical current that flows in this circuit is used to detect the level of the liquid. A variety of conductive liquids can be controlled using this method. Detecting the resistance between the electrodes and comparing it to see if it is larger or smaller than a reference resistance is used to detect the surface of the liquid.

### Principles

The operating principle is explained using a case where water is supplied from the water mains.

Office and apartment buildings normally have a ground tank and an elevated tank. Water is supplied from the water mains into the ground tank, pumped up to the elevated tank, then distributed to each floor.

When the water level in the elevated tank is low, water is pumped up from the ground tank to supplement it. When the water level reaches a certain level, the pump stops. (See figure 1.)

Elevated tanks are controlled in this manner to maintain the water level within upper and lower limits as shown below.

Figure 1. Water Supply Control

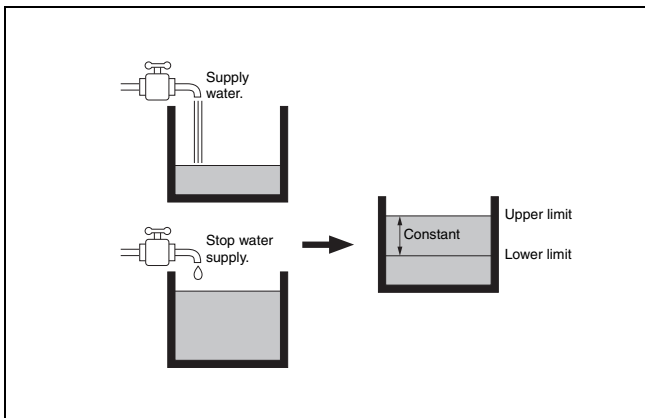

### Pump Control According to Water Level (Two-pole Method)

- (1) When electrode E<sub>1</sub> is not in contact with the conductive liquid as shown in figure 2, the electrical circuit is open, and no current flows between electrodes E<sub>1</sub> and E<sub>3</sub>. Consequently relay X does not operate and the contact remains at the **b** side.
- (2) When electrode E<sub>1</sub> is in contact with the conductive liquid as shown in figure 3, the circuit closes due to the conductive fluid completing the circuit between E<sub>1</sub> and E<sub>3</sub>. Relay X operates and switches to the **a** side. By connecting the relay contacts to a contactor, the pump can be turned ON and OFF. However in practice, with only two electrodes, ripples on the surface of the liquid cause the relay to switch rapidly. This problem can be solved by forming a self-holding circuit. (The configuration shown in figures 2 and 3 can be used as water level alarms.)

Figure 2. Low Water Level

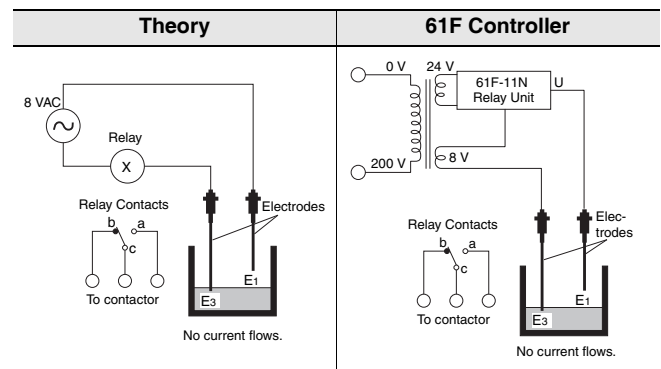
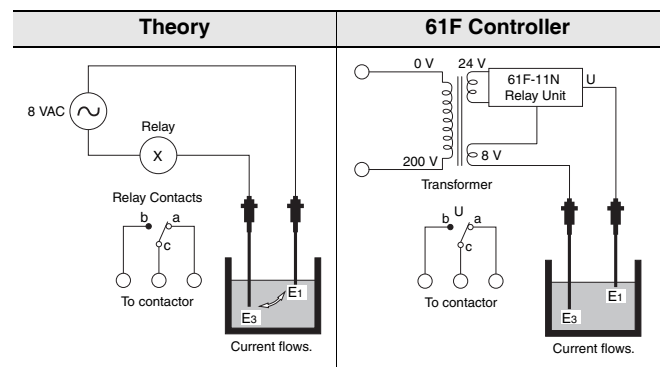

Figure 3. High Water Level



**Liquid Level Control with Self-Holding Circuit (Three-pole Method)**

An extra electrode E<sub>2</sub> is added, and E<sub>1</sub> and E<sub>2</sub> are connected via contact a2 as shown in figure 4. When electrode E<sub>1</sub> is in contact with the conductive liquid (as in point 2 of previous section), relay X operates and switches to the a side. Even if the liquid level falls below E<sub>1</sub>, the electrical circuit made through the liquid and the electrodes is retained by E<sub>2</sub> and E<sub>3</sub>, as long as contact a2 is closed.

This kind of circuit made from electrode E<sub>2</sub> and a contact is called a self-holding circuit.

When the liquid level falls below E<sub>2</sub>, the circuit made through the electrode circuit opens, which de-energizes relay X, thus closing the NC contact of X. This enables control of relay X to be switched ON and OFF between E<sub>1</sub> and E<sub>2</sub>.

Figure 5 shows the timing chart of this mechanism.

Operating as simply as it does, possible applications of the Conductive Level Controller other than liquid level control include applications as leakage detection, and object size discrimination.

**Figure 4. Self-holding Circuit**

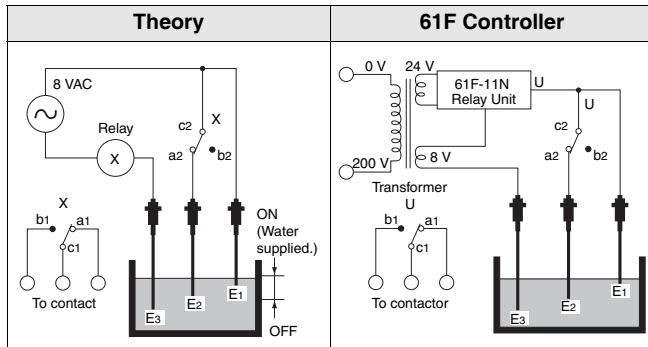

**Figure 5. Timing Chart**

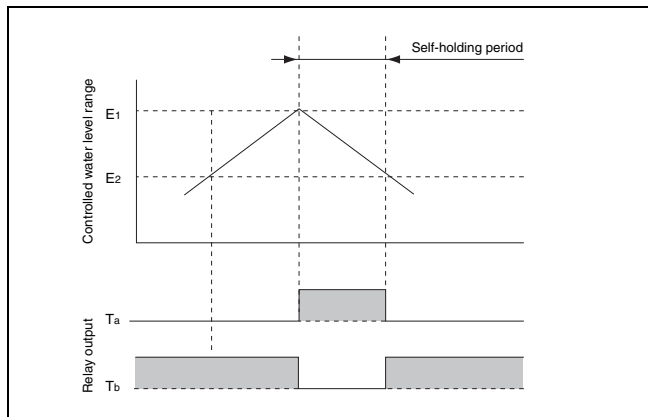

**Note:** Non-conductive liquids, such as oil, cannot be controlled using this method.

**Configuration Example**

Conductive Level Controllers are basically composed of three components: a Level Controller, Electrode Holder, and Electrodes.

When you select a product, select each of these components for your application.

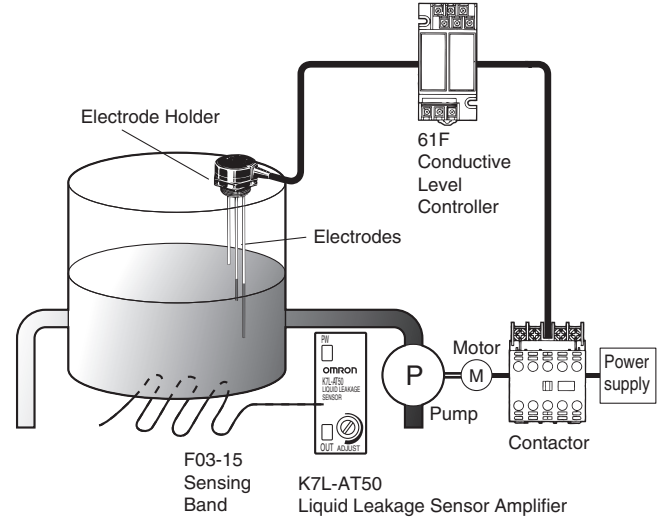

**Liquid level control is performed by combining the 61F Level Controller, Electrode Holder, and Electrodes.**

**61F Level Controller**

Select the Level Controller according to the control method, mounting method, liquid to detect, and length of wiring.



**Electrode Holder**

Select the Electrode Holder according to the environment in the water tank and the installation environment of the water tank.

**Electrodes**

Select the Electrodes according to the environment in the water tank and the control range.



**Note:** The 61F Level Controller, Electrode Holder, and Electrodes are sold separately.

Sensors  
Switches  
Safety Components  
Relays  
Control Components  
Automation Systems  
Motion / Drives  
Energy Conservation Support / Environment Measure Equipment  
Power Supplies / In Addition  
Others  
Common

## Explanation of Terms

### Types of Water

#### Purified Water

Water that has been purified for drinking, tap water available in an average household.

Water in septic tanks is treated wastewater and should not be mixed.

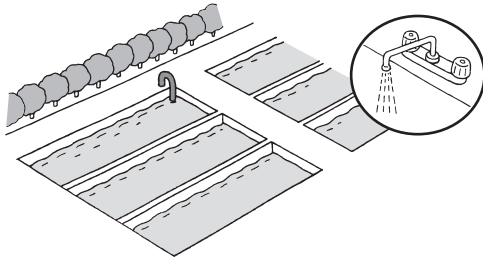

#### Wastewater

Liquid waste that goes into the sewer, such as flushed water from toilets.

**Note:** Domestic and industrial wastewater contain solids and suspended matter and has a low electrical resistance. Be very careful when installing the electrodes.

#### Purified Water

Similar meaning to purified water; however, at water treatment plants it may refer to water at a stage before it is purified so it has a broader meaning than purified water.

#### Sewage (Sewer)

Better described as a wastewater drainage system than a type of water, which eliminates the need for septic tanks, and wastewater tanks can be drained directly into the sewers. In most cases there are pipes that are connected directly to the sewer so that wastewater can be dumped directly into the sewers without wastewater tanks.

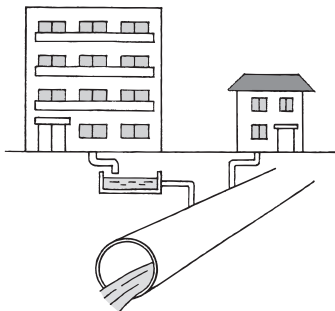

#### Rainwater

Rain collected by rainwater pits. Electrical resistance is slightly higher than purified water.

#### Spring Water

Water that flows from spring wells. Similar to rainwater, the electrical resistance is slightly higher.

#### Pumped Water

Water that is pumped to another location. Most tap water is pumped through the water mains.

#### Stored Water

Water that is stored for a purpose. Most of the time its sensitivity is same as tap water. The use of water as fire-fighting water takes priority.

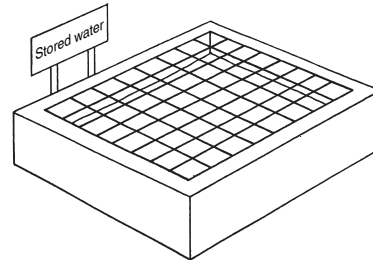

#### Ion-exchanged Water

Water that has had its ions removed. The ions are not removed by distillation, and thus electrical resistance is high.

**Note:** Generally a device with an operate resistance of 200 kΩ is used. The 61F-GP-NH3 can be used in some cases; however, the water resistance can be higher depending on the method used to remove the ions (pure water).

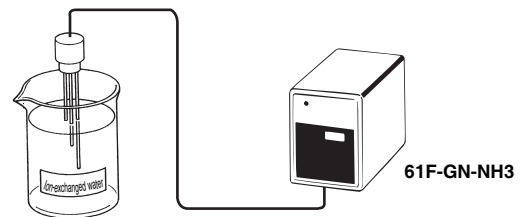

#### Distilled Water

Water that has been distilled by boiling and re-condensing the vapors. Electrical resistance is not as high as pure water.

**Note:** High-sensitivity models can be used.

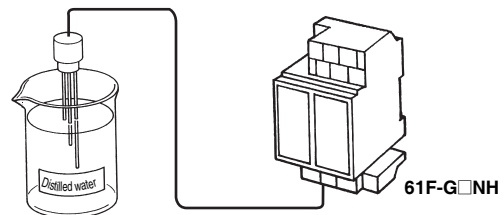

#### Return Water

Water that circulates in a boiler as steam. It is the condensed water recovered from inside the pipes.

## Pure Water

Water that is free of impurities.

It may have a resistance anywhere from 200 kΩ·cm up to 18 MΩ·cm, requiring a super high-sensitivity 61F.

**Note:** Titanium electrodes are used to preserve the purity level of the water.

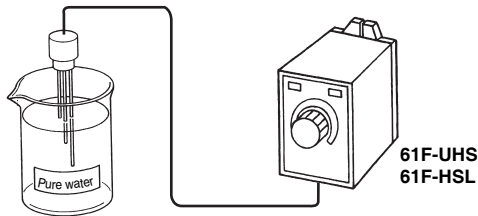

## Condensate

Cooling water from steam turbines and boilers.

## Feed Water

Water that is injected into the boiler to keep the purity level constant.

It has relatively low resistance.

## Water Tanks and Ponds

### Ground Tank

High-rise buildings and apartments that have elevated storage tanks on the rooftop temporarily store water in a ground tank before pumping it up to the elevated tank. The ground tank is often installed underground or on the ground floor.

**Note:** In this brochure, the generic term “water supply sources” is used instead of the term “ground tank.” Take into consideration the fact that ground tanks often double as fire hydrants when determining the length of electrodes. The water level of the ground tank will be controlled by a different 61F Level Controller or a float valve. (The 61F Level Controller for the elevated tank may be used and its electrodes will be in the ground tank together with the other electrodes.) The 61F-G4N is used for relatively larger buildings and apartments but due to recent Japanese government regulations that require the lower limit to be displayed, the 61F-GP-N may be added.

### Elevated Tank

Water tanks that are installed on rooftops of high-rise buildings and apartments. They use the height of the tank (i.e., gravity) to supply water.

**Note:** Water is automatically pumped from the ground tank using the 61F-G4N or 61F-G1N. With the recent introduction of pressurized water systems, some buildings do not have elevated water tanks. However, their role as storage tanks in the event of blackouts and disasters is being reconsidered.

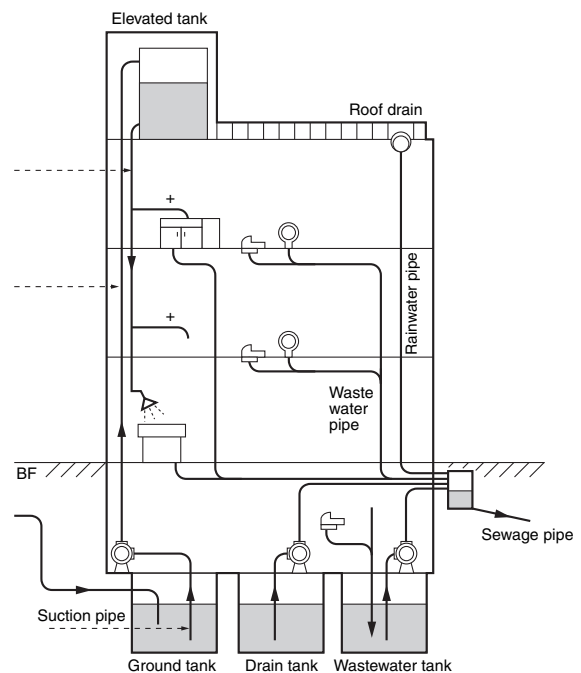

### Distribution Reservoirs

Water from the main water supply is distributed and temporarily stored in a reservoir for residential housing. These are used for separate small water supplies.

## Wastewater Tank

In cities where there are good sewage systems, the septic tank has been replaced with a temporary storage tank for wastewater from toilets and kitchens.

**Note:** In normal apartments, the wastewater will be drained directly into the sewer through the wastewater pipes; however, buildings with underground levels must use pumps to draw the wastewater up to the sewers. For this reason, a temporary storage tank for wastewater is required. These types of tanks contain grease and other solids, so each electrode must be mounted with enough separation to prevent short-circuiting.

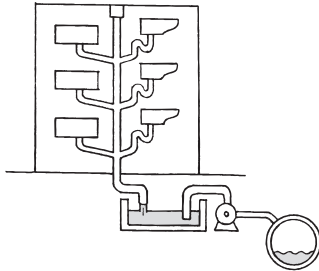

## Specifications

### Two-wire Method (Type R)

The self-holding circuit is removed to reduce the number of lines between the 61F Level Controller and the electrodes. However, the self-holding electrode is still required, so make sure that all components (Level Controller, relay unit, electrode holder, etc.) are type R with 1 W, 6.8 kΩ resistance.

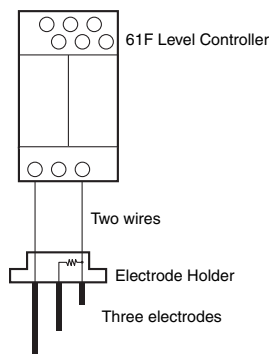

### Reference

Model	Number of lines between electrodes and the 61F Level Controller	Model	Number of lines between electrodes and the 61F Level Controller
61F-GN/-G	3	61F-GNR/-GR	2
61F-G1N/-G1	6 (See note 1.) 4 (See note 2.)	61F-G1NR/-G1R	4 (See note 1.) 3 (See note 2.)
61F-G2N/-G2	4	61F-G2NR/-G2R	3
61F-G3N/-G3	5	61F-G3NR/-G3R	4
61F-G4N/-G4	9	61F-G4NR/-G4R	7

**Note:** 1. Indicates automatic water supply control with pump idling prevention.  
2. Indicates automatic water supply control with abnormal water shortage alarm.

### Three-wire Method

Called three-wire as opposed to the two-wire method. It is the standard operation method for 61F Level Controllers.

## Supply Reservoir

The main water supply reservoir for residents created by waterworks.

Water is delivered to this reservoir from various water sources, passed through a purification plant, and supplied to the residents.

**Note:** Supply reservoirs must be maintained above a certain water level at all times. The 61F Level Controllers are often used for this purpose, and the wiring distance between the relay and the electrodes are also often very long. There are some private as well as public supply reservoirs.

## Septic Tank

Temporarily stores wastewater from toilets. The wastewater is treated to get rid of any solids before it discharges the fluid elsewhere.

**Note:** Electrodes used in septic tanks are weak alkaline types, so be careful with the insulation. In cities where the sewage system is well established, septic tanks are no longer necessary in buildings and any wastewater goes directly to the wastewater tank.

### Operate Resistance

The amount of resistance between the electrodes required for a 61F Level Controller to operate. The resistance of the liquid or solid between the electrodes must be below this value for the Level Controller to operate.

**Note:** The higher the operate resistance, higher the sensitivity, and liquid with low conductivity can be detected

### Inter-electrode resistance

Similar to the operate resistance. The operate resistance includes the resistance of the lead wires for the electrodes. If the lead wires are very long, these values are not exactly the same, but generally they can be regarded as the same.

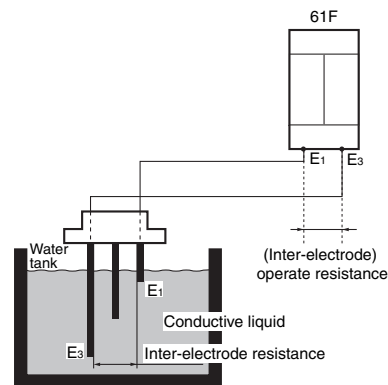

### Conductivity (Siemens: S)

Unit of electrical conductance for liquids. It is commonly expressed in micro-siemens ( $\mu\text{S}$ ) although it used to be expressed in ohms ( $\Omega$ ). It is the inverse value of electrical resistance, so the smaller it is, the higher the resistance, requiring a Level Controller with higher sensitivity.

1  $\mu\text{S}/\text{cm}$   $\rightarrow$  1 M $\Omega\cdot\text{cm}$   
2  $\mu\text{S}/\text{cm}$   $\rightarrow$  500 k $\Omega\cdot\text{cm}$   
10  $\mu\text{S}/\text{cm}$   $\rightarrow$  100 k $\Omega\cdot\text{cm}$

## Self-holding Circuit

When the relay is triggered, the value is retained by a self-holding circuit.

For the 61F-GN, electrode E<sub>2</sub> is the self-holding circuit. A self-holding circuit enables a control range to be set and also prevents the relay from switching rapidly due to ripples on the liquid surface.

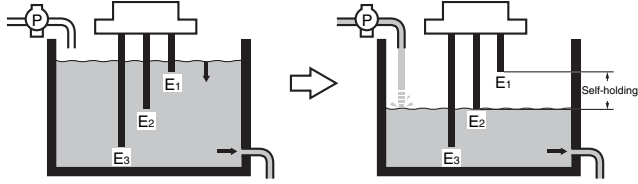

## Contact Capacity (Output)

Maximum switching capacity of the relay contact.

## Reset Resistance

The amount of resistance between the electrodes required for the 61F Level Controller to reset. The resistance must be higher than this value for the device to reset.

**Note:** If there is no liquid, the resistance should be infinite; however, if there is liquid residue on self-holding electrode and separators, it won't be infinite immediately.

This value is important for 61F Level Controllers because it affects the leakage current of the wire's float capacitance. The low-sensitivity and long distance Level Controllers are used for this purpose.

## Specific Resistance

The liquid's resistance to current flow expressed in  $k\Omega \cdot cm$ . It has an inverse relationship with conductance. (It is different to the operate resistance.)

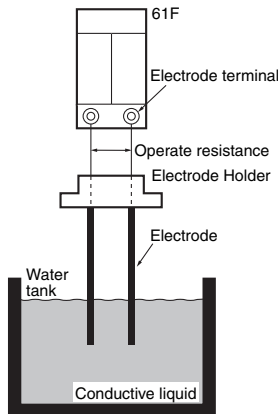

Electricity flows between the electrodes along infinite routes through the liquid.

Specific resistance is a measure of how difficult it is for current to flow along these paths. Specific resistance varies with the installation conditions of the electrodes and the submersion depth, so the actual operation depends on the distance between the electrodes and the surface area of the fluid (submersion depth). It is difficult to find the resistance between the electrodes, so the specific resistance is used as a reference value.

## Operating Voltage

The power supply voltage required for the 61F Level Controller to operate. For the 61F Level Controllers, it is at least 85% of rated voltage. Therefore the power supply voltage must not fall below 85% of rated voltage.

## Minimum Applicable Load

An estimate of the smallest load for which switching is possible in electronic circuits.

## Type of Contacts

Types of contact structure.

### Note

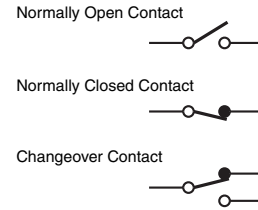

## Load

Loads can be categorized into the following three types.

- (1) Resistive loads  
When voltage is applied to appliances such as heaters, it has a constant current flow. These types of loads are called resistive loads.
- (2) Inductive loads  
Loads that have inductive components such as motors and solenoids.
- (3) Reactive loads  
Loads that have reactance such as condensers.

### Note

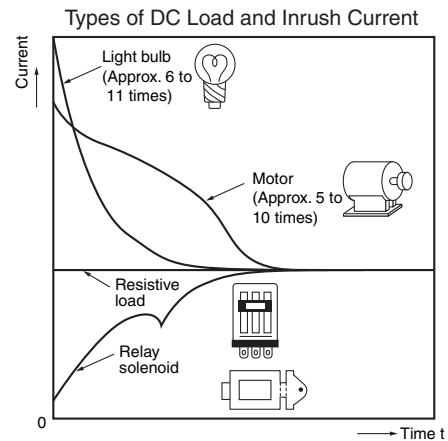

## Types of AC Load and Inrush Current

Type of load	Inrush Current/ Rated Current	Waveform
Solenoid 	Approx. 60 times	
Incandescent light bulb 	Approx. 10 to 15 times	
Motor 	Approx. 5 to 10 times	
Relay 	Approx. 2 to 3 times	
Resistive load 	--	

**Inrush Current**

The instantaneous current flow when the contact is closed or the transitive current is higher than the steady-state current.

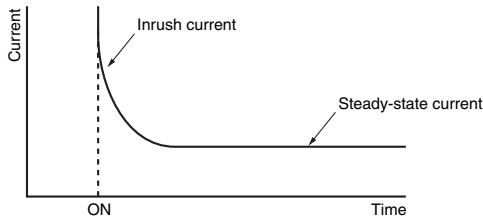

**Switching Frequency**

The number of times a relay switches in one time unit. The time unit is a discrete unit, such as per hour.

**Operation**

**Idling Prevention**

In high-rise buildings and apartments, water is pumped up from ground tanks to elevated tanks. If the ground tanks run out of water and the pump is still operating, the pumps starts pumping air and overheats the motors, potentially causing a burnout. To prevent this from happening, the pumps are stopped once the water drops below a certain level. The 61F-G1N/-G1 and 61F-G4N/-G4 have this function.

**Alternate Operation**

In larger applications where water is pumped using a motor, there will be a spare motor. If the spare motor is not used, it may get rusty and deteriorate. If it is used continuously, it will also deteriorate due to generation of heat. By alternating control of the two motors, the effective life of the motors is extended and when one of them breaks down, it can maintain operation with the other one. (An external switch is required.) The 61F-AN/-APN2 support this function.

**Initial Operation Method**

The internal relay operates when power is applied to the 61F and resets when current flows between the electrodes. However, the operation after resetting and the wiring are the same as for models with sequential operation.

**Sequential Operation Method**

The internal relay switches when current flows between electrodes.

**Note:** All models except high-sensitivity models use this method. The 61F-G□NH also uses this method.

## Further Information

### Level Controller Selection Criteria

#### Categories (Reference Information)

##### Categorized by Fluid Types

Applicable liquids	Electrode	Electrode Holders	Relay Unit
Acid/alkaline solutions	Select electrodes based on corrosion resistance <i>Table 4 on page 11</i> . (Separators are not used.)	Electrodes in BS-IT are outlined in <i>Table 4 on page 11</i> . Separate each electrode with insulation.	Low-sensitivity 61F-□□ND Level Controller (61F-11ND or equivalent, however depending on the cable length, the long-distance 61F-11NL Level Controller may be required.)
Boiler	SUS316 (The materials used make the water alkaline.)	BS-1 (Subject to high temperature and pressure.)	Standard 61F-□□ Level Controller
Tap water	SUS304, SUS316	PS, BF. No other specific requirements.	Standard 61F-□□ Level Controller, but when it is over a long distance, use a long-distance 61F-□□L Level Controller.
Pure water (Ion-exchanged water)	Titanium (Maintains the purity level of water.)	BS-1T Titanium	May require a high-sensitivity Level Controller depending on conductivity 61F-□□NH (61F-11NH) Ultra-high-sensitivity 61F-UHS Level Controller
Bubbles (Detection)	SUS304, SUS316, Titanium (Separators are not used.)	PS, BF	High-sensitivity 61F-GP-NH Level Controller or equivalent
Bubbles (No detection)	As above (Separators are not used.)	As above	Low-sensitivity 61F-□□ND Level Controller
Wastewater	SUS304 (Low salinity) (Separators are not used.)	BF-1 is used with each electrodes separated.	Low-sensitivity 61F-□□ND Level Controller
Oil mixed in water *	SUS304	PS, BF use pipes to guard against the oil.	Standard 61F-□□ Level Controller
Steam	SUS316	PS-1, BF-1 If there is enough pressure to be able to separate the electrodes, use the BS-1.	Standard 61F-□□ Level Controller

\* Oil does not allow electricity to pass through, preventing detection.

##### Categorized by Installation Conditions of Electrodes

Installation Condition	Electrode	Electrode Holder
Confined space	PH underwater electrodes	---
Protect against rainwater	SUS304, SUS316	PS + F03-11 Protective Cover + F03-12 Frame
Objects from wastewater (i.e., clothing) get tangled	SUS304	The BF-1; separates the distance between electrode holders
Wastewater, contaminated water, or areas with clusters of grease	SUS304 or SUS316	As above
Elevated tank	SUS304 or SUS316	PS
Ground tank	SUS304 or SUS316, F03-05 Electrode Band, PH underwater electrodes	PS
Sewer, drains (manhole)	SUS304, SUS316	PS (Place the electrodes in a pipe in areas that accumulate grease, e.g., underground, factory pits)
Septic tank (Flushed matter)	SUS304	BF-1
Measurements at a depth like water wells	PH underwater electrodes	---
Areas where ice forms	PH underwater electrodes	---
High temperature (hot water tank)	SUS316	Temperatures under 50°C, BS-1S2 No model is suitable for temperatures above 250°C (Must be made by the user.)



## Selection Criteria for 61F Level Controllers

### Specific Resistance and Model Selection Criteria

The limit for specific resistance of liquid that can be controlled with a generic Level Controller is 30 kΩ·cm when using a PS-3S Electrode Holder within a submersion depth of 30 mm. For any fluid with specific resistance higher than this value, use a high-sensitivity Level Controller (H type). (See note.)

Table 1 and Table 2 shown on the right and Table 3 on the next page show specific resistances for typical liquids. Use these when selecting a model.

- Note: 1.** The high-sensitivity Level Controllers may suffer from resetting problems when used with certain types of water. In some cases it cannot substitute for the standard Level Controllers or Low-sensitivity Level Controllers. Be sure to select the model appropriate for the application.
- 2.** The circuit configuration of the High-sensitivity 61F-□H Level Controller is designed so that the relay is reset when there is water present between the electrodes. When power supply voltage is applied, the internal relay switches to the NO contact and, when there is conductivity between electrodes E<sub>1</sub> and E<sub>3</sub>, the relay is reset to the NC contact. This contact operation is reversed for models other than the high-sensitivity models. Although the internal relay operates (and operation indicator turns ON) simply when the power supply voltage is applied, this operation is normal. (The relay in the 61F-□NH energizes when there is water present between the electrodes.)

**Note:** For the ultra high-sensitivity variable 61F-HSL Level Controller, malfunction due to electric corrosion may occur in the DC electrode circuit. Be careful not to use the product where current constantly flows between electrodes.

**Table 1: Specific Resistance of Water (General Guideline)**

Type of water	Specific resistance
Tap water	5 to 10 kΩ·cm
Well water	2 to 5 kΩ·cm
River water	5 to 15 kΩ·cm
Rainwater	15 to 25 kΩ·cm
Seawater	0.03 kΩ·cm
Sewage	0.5 to 2 kΩ·cm
Distilled water	250 to 300 kΩ·cm min.

**Table 2: Detectable Specific Resistance (Guideline)**

Type of use	Specific resistance (recommended value)
Long distance (4 km)	5 kΩ·cm max.
Long distance (2 km)	10 kΩ·cm max.
Low sensitivity	10 kΩ·cm max.
Two-wire	10 kΩ·cm max.
General-purpose	10 to 30 kΩ·cm
High-temperature	10 to 30 kΩ·cm
High-sensitivity (COMPACT plug-in type)	30 to 200 kΩ·cm
High-sensitivity (base type)	30 to 300 kΩ·cm
Ultra high-sensitivity	100 kΩ to 10 MΩ·cm

**Note:** The specific resistance of liquids are those that can be controlled using the PS-3S when the submersion depth is 30 mm or less.

### Conductance

Conductance is a scale describing how easily current can flow. The relationship of conductance and resistance is defined by the following equation.

$$\text{Conductance} = \frac{1}{\text{Resistance } (\Omega)} \text{ (siemens: S)}$$

Table 1 can be modified to contain the corresponding conductance as shown in Table 1A.

**Table 1A: Specific Conductance of Water (Guideline)**

Type of water	Specific Conductance
Tap water	100 to 200 μS/cm
Well water	200 to 500 μS/cm
River water	67 to 200 μS/cm
Rainwater	40 to 67 μS/cm
Seawater	33,300 μS/cm
Sewage	500 to 2,000 μS/cm
Distilled water	3.3 to 4 μS/cm max.

Table 3: Specific Resistance of Various Liquids

Type of liquid	Temperature (°C)	Concentration (%)	Specific resistance (Ω·cm)
Beer (Company A)	12	---	830.0
Port wine (Company K)	12	---	966.0
Whisky (Company T)	12	---	14,608.0
Sake (Company K First grade quality)	12	---	1,743.0
Silver nitrate AgNO <sub>3</sub>	18	5.0	39.5
		60.0	4.8
Barium hydroxide Ba(OH) <sub>2</sub>	18	1.25	40.0
		2.5	20.9
Calcium chloride CaCl <sub>2</sub>	18	5.0	15.6
		20.0	5.8
		35.0	7.3
Cadmium chloride CdCl <sub>2</sub>	18	1.0	181.0
		20.0	33.5
		50.0	73.0
Cadmium sulfate CdSO <sub>4</sub>	18	1.0	240.0
		5.0	68.5
		35.0	23.8
Nitric acid HNO <sub>3</sub>	18	5.0	3.9
	15	31.0	1.3
	15	62.0	2.0
Phosphoric acid H <sub>3</sub> PO <sub>4</sub>	15	10.0	17.7
		60.0	5.5
		87.0	14.1
Sulphuric acid H <sub>2</sub> SO <sub>4</sub>	18	5.0	4.8
		30.0	1.4
		97.0	12.5
		99.4	117.6
Potassium bromide KBr	15	5.0	14.5
		36.0	2.9
Potassium chloride KCl	18	5.0	14.5
		21.0	3.6
Potassium chlorate KClO <sub>3</sub>	15	5.0	27.2
Potassium cyanide KCN	15	3.25	19.0
		6.5	9.8
Potassium carbonate K <sub>2</sub> CO <sub>3</sub>	15	5.0	17.8
		30.0	4.5
		50.0	6.8
Potassium fluoride KF	18	5.0	15.3
		40.0	4.0
Potassium iodide KI	18	5.0	31.4
		55.0	2.4
Potassium nitrate KNO <sub>3</sub>	18	5.0	22.1
		22.0	6.2
Potassium hydroxide KOH	15	4.2	6.8
		33.6	1.9
		42.0	2.4
Potassium monosulfide K <sub>2</sub> S	18	3.18	11.8
		29.97	2.2
		47.26	3.9

Type of liquid	Temperature (°C)	Concentration (%)	Specific resistance (Ω·cm)
Copper sulfate CuSO <sub>4</sub>	18	2.5	92.6
		17.5	21.8
Ferrous sulfate FeSO <sub>4</sub>	18	0.5	65.0
		3.0	21.7
Hydrogen bromide HBr	15	5.0	5.2
		15.0	2.0
Hydrochloric acid HCl	15	5.0	2.5
		20.0	1.3
		40.0	1.9
Hydrogen fluoride HF	18	0.004	4,000.0
		0.015	2,000.0
		0.242	275.0
		29.8	2.9
Mercuric chloride HgCl <sub>2</sub>	18	0.229	22,727.0
		5.08	2,375.0
Hydrogen iodide HI	15	5.0	7.5
Potassium sulfate K <sub>2</sub> SO <sub>4</sub>	18	5.0	21.8
		10.0	11.6
Sodium chloride NaCl	18	5.0	14.9
		25.0	5.6
Sodium carbonate Na <sub>2</sub> CO <sub>3</sub>	18	5.0	22.2
		15.0	12.0
Sodium iodide NaI	18	5.0	33.6
		40.0	4.7
Sodium nitrate NaNO <sub>3</sub>	18	5.0	22.9
		30.0	6.2
Sodium hydroxide NaOH	15	2.5	9.2
		20.0	2.9
		42.0	8.4
Sodium sulfate Na <sub>2</sub> SO <sub>4</sub>	18	5.0	24.4
		15.0	11.3
Ammonia NH <sub>3</sub>	15	0.1	3,984.0
		4.01	913.0
		3.05	5,181.0
Ammonium chloride NH <sub>4</sub> Cl	18	5.0	50.5
		25.0	2.5
Ammonium nitrate NH <sub>4</sub> NO <sub>3</sub>	15	5.0	16.9
		50.0	2.7
Ammonium sulfate (NH <sub>4</sub> ) <sub>2</sub> SO <sub>4</sub>	15	5.0	18.1
		31.0	4.3
Zinc chloride ZnCl <sub>2</sub>	15	2.5	36.2
		30.0	10.8
		60.0	27.1
Zinc sulfate ZNSO <sub>4</sub>	18	5.0	52.4
		30.0	22.5

Sensors

Switches

Safety Components

Relays

Control Components

Automation Systems

Motion / Drives

Energy Conservation Support / Environment Measure Equipment

Power Supplies / In Addition

Others

Common

### Selecting Electrode Material According to Resistance against Corrosion

To get the most out of the electrodes, refer to *Table 4* to select the best material.

**Table 4: Resistance to Corrosion of Electrode Material**

Aqueous Solution			Electrode material				
Type	Concentration (%)	Temperature (°C)	SUS 304	SUS 316	Titanium	HAS B	HAS C
Sulphurous acid H <sub>2</sub> SO <sub>3</sub>	6	30	E	C	A	B	B
	1	30	A	A	A	A	A
	1	BP	E	D	E	B	C
	3	30	B	A	A	A	A
	3	BP	E	E	E	C	C
	5	30	D	B	D	B	A
	5	BP	E	E	E	D	D
	10	30	E	C	E	A	A
	10	BP	E	E	D	C	E
	20	30	E	E	C	C	B
Sulphuric acid H <sub>2</sub> SO <sub>4</sub>	20	BP	E	E	D	D	E
	40	30	E	E	D	B	B
	40	BP	E	E	D	E	E
	60	30	E	E	D	B	C
	60	BP	E	E	D	C	D
	70	30	E	E	D	B	B
	70	BP	E	E	D	C	D
	80	30	E	E	D	B	B
	80	BP	E	E	D	D	D
	90	30	E	E	D	B	B
Hydrochloric acid HCl	90	BP	E	E	D	D	D
	95	30	E	D	D	B	B
	95	BP	E	E	D	D	D
	1	30	E	D	B	B	A
	1	BP	E	E	E	D	C
	3	30	E	E	B	B	A
	3	BP	E	E	E	D	C
	5	30	E	E	C	C	A
	5	BP	E	E	E	E	D
	10	30	E	E	E	C	C
Chromium oxide CrO <sub>3</sub>	10	BP	E	E	E	E	E
	10	BP	E	E	E	E	E
	15	30	E	E	E	C	C
	15	BP	E	E	E	E	E
	20	30	E	E	E	C	D
	20	BP	E	E	E	E	E
	37	30	E	E	E	C	E
	37	BP	E	E	E	E	E
	10	BP	D	C	A	B	C
	20	30	C	B	A	B	B
Nitric acid HNO <sub>3</sub>	36.5	90	E	E	C	C	C
	10	30	B	A	A	D	A
	10	BP	B	B	B	D	C
	20	290	B	B	C	D	D
	65	175	C	C	B	E	E
Hydrogen fluoride HF	68	30	C	C	A	D	D
	68	BP	D	D	B	E	E
	90	80	E	E	A	E	E
Phosphoric acid H <sub>3</sub> PO <sub>4</sub>	5	30	E	E	D	D	C
	100	30	E	D	C	C	C

Aqueous Solution			Electrode material				
Type	Concentration (%)	Temperature (°C)	SUS 304	SUS 316	Titanium	HAS B	HAS C
Acetic acid CH <sub>3</sub> COOH	5 to 50	RT	A	A	A	A	A
	100	RT	A	A	A	A	A
	100	BP	C	B	A	A	A
Formic acid H-COOH	All	BP	D	D	D	A	A
Acetone CH <sub>3</sub> -CO-CH <sub>3</sub>	All	RT	B	B	A	A	A
Alum	All	RT	E	E	D	B	B
Aluminum sulfate	50	BP	D	C	B	C	A
Ammonium chloride NH <sub>4</sub> Cl	5	BP	D	D	A	B	B
Ammonium nitrate NH <sub>4</sub> NO <sub>3</sub>	All	BP	A	A	A	B	B
Ammonium sulfate (NH <sub>4</sub> ) <sub>2</sub> SO <sub>4</sub>	5	RT	E	D	B	B	C
	10	BP	E	E	B	B	C
	100	100	C	C	A	B	B
Ammonia NH <sub>3</sub>	10	BP	C	B	B	B	C
	28	60	C	B	A	B	B
	25	BP	B	A	C	B	C
Potassium hydroxide KOH	30	60	A	A	B	A	B
Sodium hydroxide NaOH	50	65	B	A	C	A	C
	25	BP	B	B	B	B	B
Sodium carbonate Na <sub>2</sub> CO <sub>3</sub>	20	BP	B	B	B	B	B
Potassium carbonate K <sub>2</sub> CO <sub>3</sub>	50	150	D	C	B	B	C
Zinc chloride ZnCl <sub>2</sub>	25	BP	C	C	A	A	A
Calcium chloride CaCl <sub>2</sub>	25	BP	C	B	A	B	B
Sodium chloride NaCl	30	RT	E	E	A	E	B
Ferric chloride	30	RT	E	E	A	E	B
Copper chloride	30	RT	E	E	A	E	B
Sea water		RT	C	C	A	B	A
Hydrogen peroxide H <sub>2</sub> O <sub>2</sub>	10	RT	B	B	B	B	B
Sodium sulfite	10	RT	B	B	A	B	B
Citric acid	All	RT	B	A	C	A	A
Oxalic acid CO <sub>2</sub> H-CO <sub>2</sub> H	All	RT	B	A	D	B	B
Sodium hypochlorite	10	RT	E	D	A	C	C
Potassium dichromate	10	BP	C	B	A	B	C
Magnesium chloride	30	RT	C	B	A	A	A
Magnesium sulfate	10	RT	B	B	A	A	A

- Note:**
- RT: Room temperature  
BP: Boiling point
  - A: Adequate resistance to corrosion  
B: Resistive to corrosion, erosion rate is less than 0.8 mm/year  
C: Low resistance to corrosion, erosion rate is less than 1.8 mm/year  
D: Highly corrosive, not usable  
E: No resistance to corrosion, not usable
  - The table above is used for reference when selecting the electrodes. Even if the material has adequate corrosion resistance, it doesn't mean that it is not subject to corrosion. Check regularly once a month to see if corrosion is occurring. If it is, replace the electrodes.

**Reference**

When selecting an Electrode Holder, make sure that you consider the corrosion resistance of the material of electrode holders as it may be exposed to the liquid inside the water tank.

Sensors  
Switches  
Safety Components  
Relays  
Control Components  
Automation Systems  
Motion / Drives  
Energy Conservation Support / Environment Measure Equipment  
Power Supplies / In Addition  
Others  
Common

## Level Controller Installation

### Attaching Electrodes to the Electrode Holder

#### Appearance

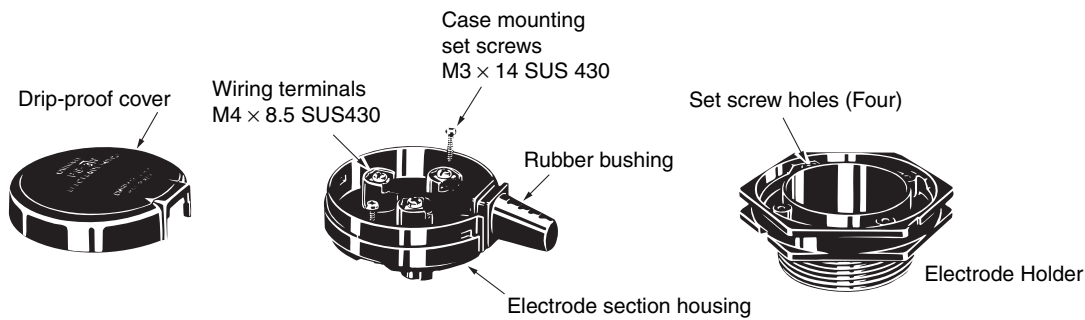

#### 1. Removing the cover

- (1) Wedge a flat-blade screwdriver into the groove on either side of the rubber bushing and lever it off alternately. (The cover may break if you lever it too much on one side.)

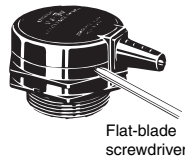

- (2) Undo the two set screws and lift off the electrode section.

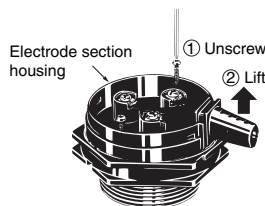

#### 2. Mounting

- (1) Screw the Electrode Holder into the coupling (54 dia.) secured at the installation location.

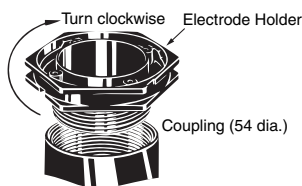

- (2) Screw in the electrodes until it cannot be turned any further, tighten the lock nut, and then secure them with the clamp screws (M3.5).

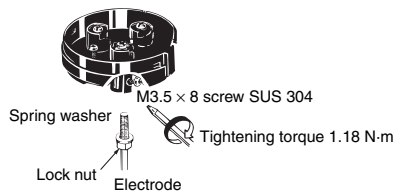

- (3) Attach the electrode section to the Electrode Holder.

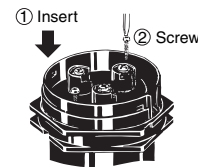

(Secure with the two case mounting screws. Tightening torque 0.7 N·m)

- (4) The rubber bushing can be cut with a utility knife if the hole size requires adjustment to fit the cables.



- (5) Connect the leads to the respective terminals. (Fit the rubber bushing in position as shown in the diagram below.)



- (6) Put the claw at the back of the cover into the hole at the back of the electrode section housing and push it close until you hear a click.



### Installing an Electrode Holder on a Tank

**Note:** Electrode Holders should always be installed from above the tank.

#### Method 1

Fabricate screw threads of the same size as PF2 in the tank.

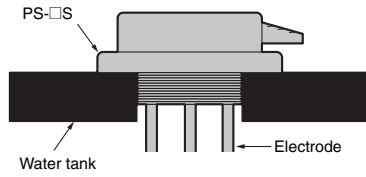

#### Method 2

Use a commercially available coupling (PF2 parallel thread (effective dia.: 58.135) JIS B0202.)

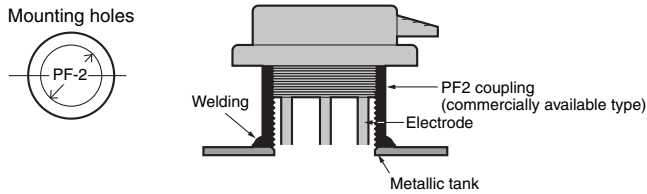

#### Method 3

Drill a hole (65 dia.) in the tank and insert the Electrode Holder. Use an F03-12 Frame (sold separately) as a nut from below and secure in place.

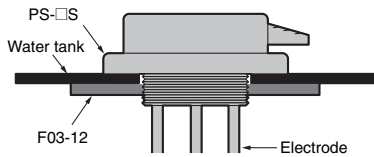

#### Method 4

Use the F03-12 Frame (sold separately) as a flange.

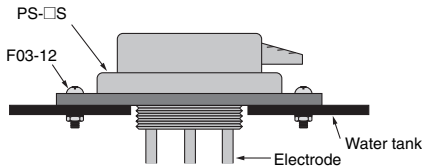

- (1) Drill a hole in the tank.
- (2) Attach the Frame over the hole.  
(Tighten the four F03-12 mounting screws.)

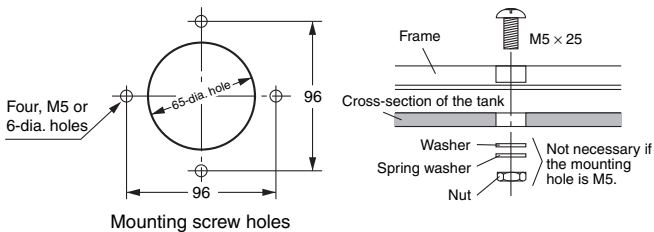

#### Method 5

Use F03-12 and F03-13 Frames (both sold separately) together and embed them in the concrete.

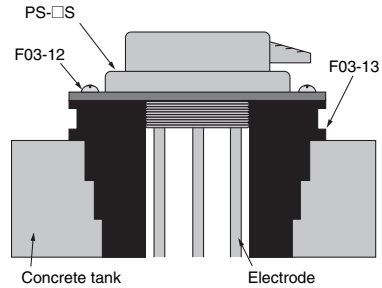

### Mounting the F03-11 Protective Cover (Sold Separately)

The protective cover can only be used for methods 4 and 5 described in the previous section.

#### PS-S(R) Series

Attach the F03-12 Frame to the bottom of the PS-series Electrode Holder. (See diagram below.)

Next, place the F03-11 Protective Cover on top of the Electrode Holder and press on it until it clicks into place.

**Note:** The cap screw attached to the protective cover is not required for mounting.

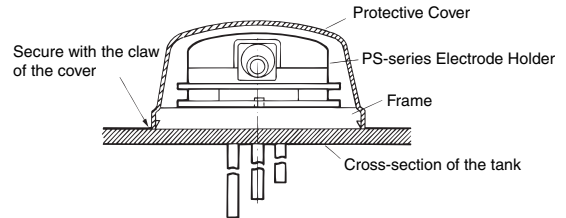

#### BF-series Electrode Holder (Applicable to BF-3(R), -5(R))

Remove the two mounting screws (M5 x 25) of the BF-series Electrode Holder and attach the two cap screws (M5 x 25) provided with the F03-11 Protective Cover.

Next, put the Protective Cover over the top of the BF-series Electrode Holder, and then tighten the two enclosed screws (M3 x 20 with washers). See diagram below.

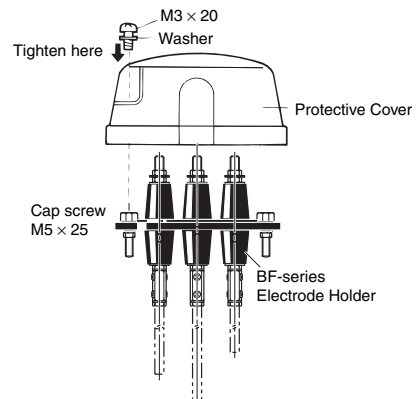

**Note:** The Protective Cover cannot be mounted on the BF-1.

## Mounting Electrodes

### Connecting Electrodes to Electrode Holders

- (1) Place a lock nut onto the electrode.
- (2) Fully fit the electrode into the connecting nut attached to the Electrode Holder.
- (3) Tighten the lock nut.
- (4) Tighten the electrode with the two clamp screws.

### Applicable units

**BF Series**  
**BS Series**

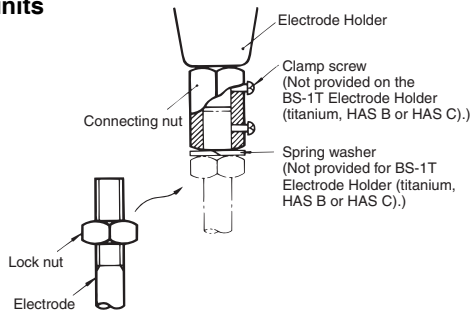

### Connecting One Electrode to Another

- (1) Put a lock nut onto each electrode at its end.
- (2) Fit each electrode into the connecting nut so that the ends meet at the center.
- (3) Tighten the lock nuts.
- (4) Tighten the electrodes with the two clamp screws.

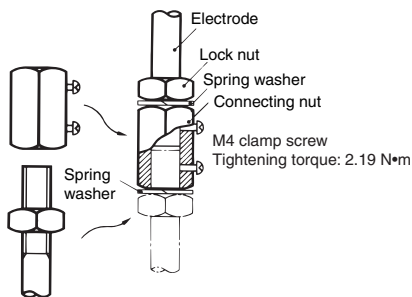

## Spring washer

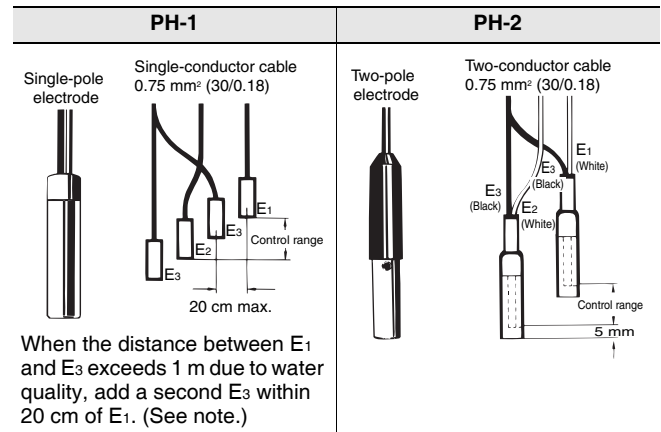

**Note:** Even when the distance is less than 1 m, the product may not operate due to the water quality.

### Example

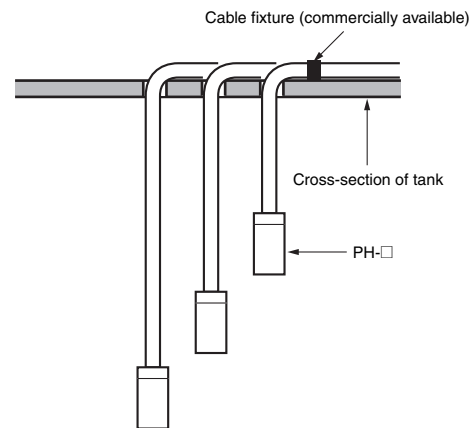

## Electrode Band Mounting

### Connecting Electrode Holder and Electrode Band

Screw the Electrode Band Connecting Nut into the Electrode Nut inside the Electrode Section Housing, and then secure it with the clamp screws. Next, insert the Electrode Band into the Electrode Band Connecting Nut and tighten the two screws so that the core wire in the Electrode Band will come into contact with the Connecting Nut. Then, secure the Electrode Holder to the Electrode Section Housing with the two screws and put the Drip-proof Cover on top.

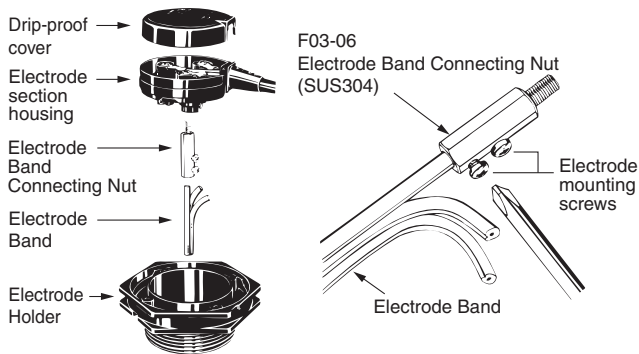

### Mounting Electrode Band Weights

#### Mounting Weight 1

Insert the Electrode Band inside the Electrode Band Weight and firmly tighten the two screws at either (A) or (B). The screws will come into contact with the core in the Electrode Band, allowing the Electrode Band Weight to become an electrode plate.

(Be sure to use the screw holes at either (A) or (B).) The Electrode Band has guides as shown by the arrow below for the connecting screws so that connecting screws can be correctly inserted into the center of the core wire.

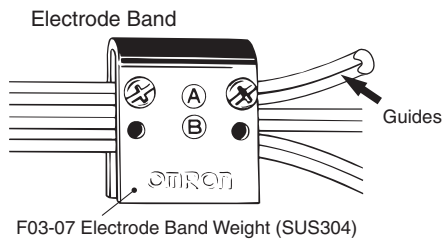

#### Mounting Weight 2

Electrode Band Weights can be attached at positions E<sub>1</sub>, E<sub>2</sub>, and E<sub>3</sub> by changing the heights. These will be the contact surface between the liquid and the conductors, thus creating short, medium, and long electrodes.

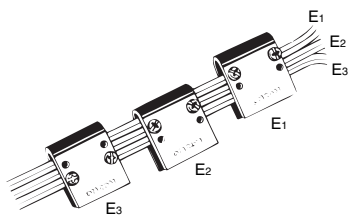

### Mounting Insulation Caps

Cover each Electrode Band Weight with an Insulation Cap to prevent false detection due to contact between the Electrode and water tank. Deform the Insulation Cap to an ellipsoid before installing it on the Electrode Band Weight.

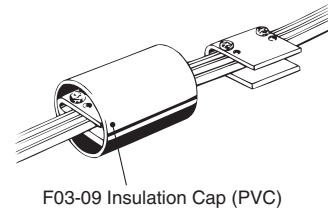

### Mounting End Caps

Cover the ends of the Electrode Band with the End Caps and glue them with F03-10 Electrode Band Adhesive (sold separately) to prevent water from entering between the sheaths and the End Caps.

Five end caps can be glued with one Adhesive.

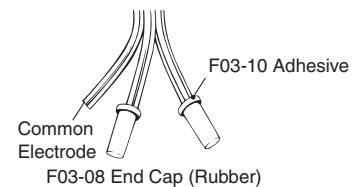

### Completed Mounting Band

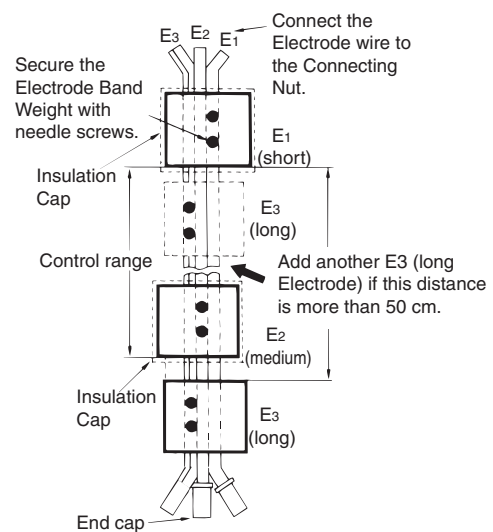

For purified water, if the distance between long electrode E<sub>3</sub> and short electrode E<sub>1</sub> is 50 cm or longer, add an Electrode Band Weight as an additional E<sub>3</sub> near E<sub>1</sub> at a distance of 15 to 20 cm.

Refer to *Mounting Weight 2 in Mounting Electrode Band Weights*. Long Electrode E<sub>3</sub> does not require an End Cap.

### Number of Parts Required During Installation (Electrodes)

Automatic Water Supply and Drainage Control

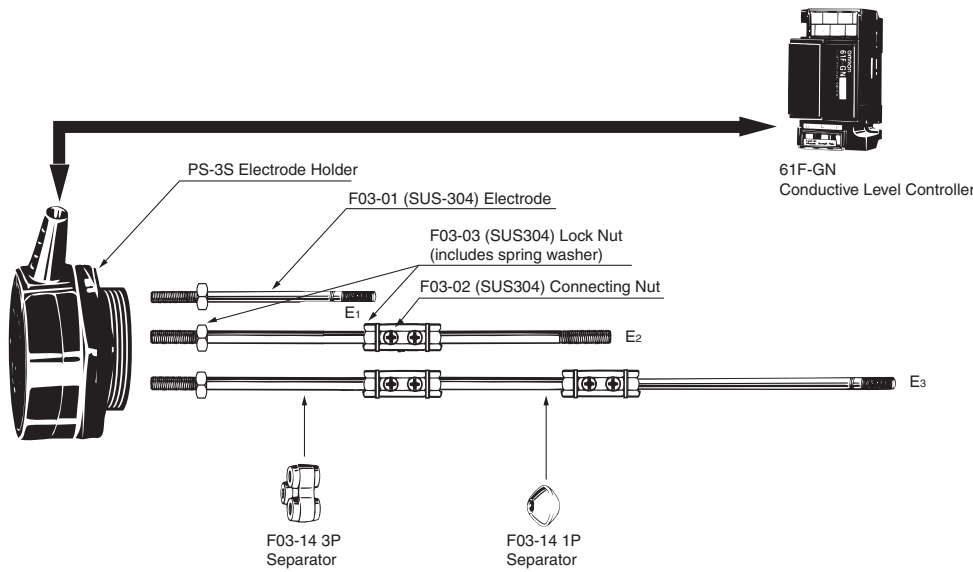

**Number of Parts  
Required for E<sub>1</sub> = 1 m,  
E<sub>2</sub> = 2 m, E<sub>3</sub> = 3 m**

61F-GN .....	1
PS-3S .....	1
F03-01(SUS304).....	6
F03-02(SUS304).....	3
F03-03(SUS304).....	9
F03-14 3P .....	1
F03-14 1P .....	1

### Number of Parts Required During Installation (Electrode Bands)

Automatic Water Supply and Drainage Control

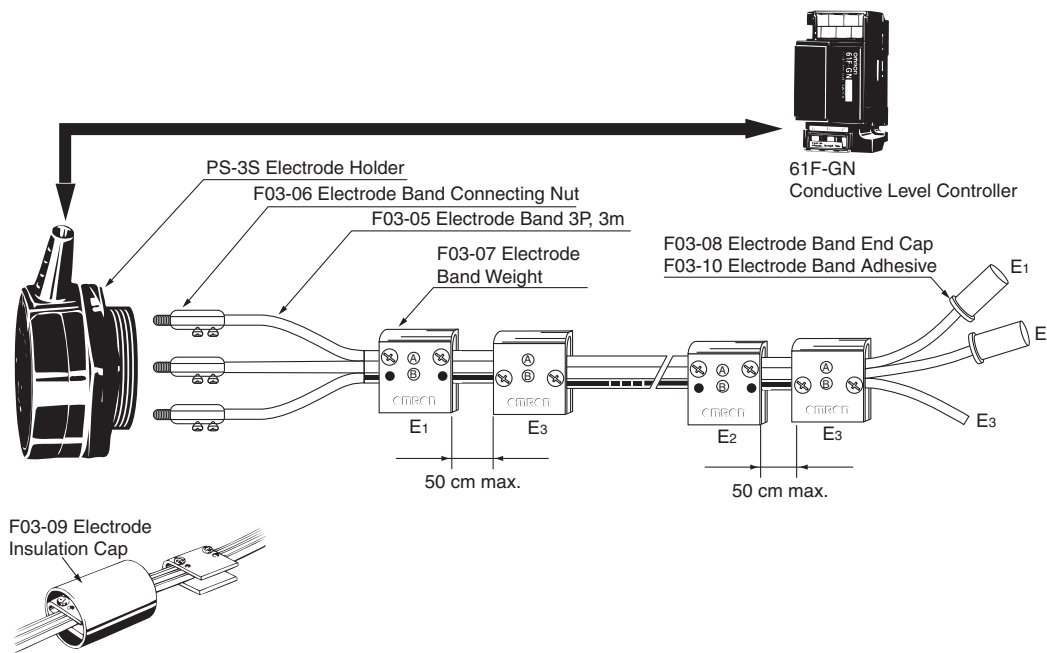











**Number of Parts  
Required for a 3-m  
Electrode Band:**

61F-GN .....	1
PS-3S .....	1
F03-06 .....	3
F03-05 3P .....	3
F03-07 .....	4
F03-08 .....	2
F03-09 .....	2
F03-10 .....	1

Sensors  
Switches  
Safety Components  
Relays  
Control Components  
Automation Systems  
Motion / Drives  
Energy Conservation Support / Environment Measure Equipment  
Power Supplies / In Addition  
Others  
Common

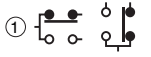

Summary of Element Symbols Used in Connection Diagrams

Element	Symbol		Details
	Denotation in product catalogs	Denotation by JIS	
NO contact	 or 		Normally open contact. Contact is open when the relay is inactive.
NC contact	 or 		Normally closed (NC) contact. Contact is closed when relay is inactive.
Changeover contact	①  or 		Changeover contacts control two circuits, one normally open contact and one normally closed contact with a common terminal. Symbols ① and ② are equivalent.
Relay			Magnetic relay.

Sensors

Switches

Safety Components

Relays

Control Components

Automation Systems

Motion / Drives

Energy Conservation Support / Environment Measure Equipment

Power Supplies / In Addition

Others

Common

FAQs

Electrodes and Electrode Holders



**Can the electrodes be cut off?  
Are there longer ones?**



Electrodes are sold in 1-m increments.

**Electrode (F03-01)**

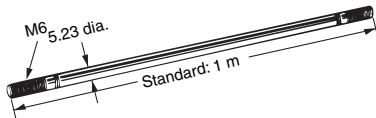

- There are threads at both ends so it can be cut in half and used as two electrodes. The threads (M6) have been created by rolling but you cannot roll a new thread.
- When the required length of electrode is more than 1 m, connect two electrodes with connecting nuts and lock nuts (2 pieces) or a spring washer for SUS.
- If the electrodes are too long, it may cause problems with the signal intensity and handling becomes cumbersome. A cable type electrode (PH) or an Electrode Band is more suitable.



**What is an electrode assembly?**



An electrode assembly consists of an electrode, a connecting nut, two lock nuts, and two spring washers. HAS B, HAS C, and titanium electrodes do not come in assemblies.

**Electrode Assembly Models**

Model	Material
F03-60: SUS304	SUS304
F03-60: SUS316	SUS316

**Electrode Assembly (F03-60)**



	Distance to the water surface is long (one-pole)	Distance to the water surface is long (two-pole)
<b>Application</b>		
<b>Model</b>	<b>PH-1</b> 	<b>PH-2</b> 
<b>Features and application examples</b>	For a deep-well pump or anywhere there is accumulation of dirt and lime deposits, use a few electrodes together. Maximum cable length is 100 m.	Use in application where the distance to the water surface is long, such as a deep-well pump or a submerged pump. Suspend a few pairs to mark the upper and lower limits. Maximum cable length is 100 m.
<b>Operating temperature</b>	Vinyl cable: -10 to 60°C Hypalon cable: -30 to 70°C	Vinyl cable: -10 to 60°C Hypalon cable: -30 to 70°C

**Note:** Hypalon is a registered trademark of Mitsui Chemicals, Inc.

**Note** Always use a lock nut so that the electrode doesn't become loose.

**Comment** Water inside the water tank may appear still even when it is actually flowing. This can cause considerable pressure on the electrodes, so make sure that they are secured properly. Also, sometimes the rods may bend from the force of the water. For applications involving tap water, use a separator.



**Is it OK to short circuit the electrodes?**



There are no problems with short-circuiting the electrodes deliberately as part of a test or even during actual operation.

**Comment**

The impedance between the electrodes is equivalent to the internal impedance of the relay unit, so even if a short circuit was created across the electrodes, the current flow would be less than 2 mA (for a standard Level Controller.) For a high-sensitivity or ultra high-sensitivity Level Controller, the current would be in the order of  $\mu\text{A}$ .

**Note**

When creating a short circuit across the electrodes using a switch, a low resistance switch must be used.



**Can electrodes be shared?**



Electrodes cannot be shared.

Do not connect a single electrode to more than one 61F. If the phases of the 8-VAC electrode-circuit power supplies are opposite to each other, as shown in *Figure 1*, an internal close circuit (return circuit) is created (indicated by the arrows). The 61F may malfunction regardless of the liquid level when the 61F power is turned ON. This problem can be overcome by matching the power supply phases, as shown in *Figure 2*, but in this configuration the internal impedance of the 61F calculated from the electrode will be approximately half as large as the internal impedance of a single 61F. The same phenomenon can occur if multiple (not shared) electrodes, connected to separate 61F Level Controllers, are installed close together inside a single tank. Maintain sufficient clearance between electrodes connected to separate 61F Level Controllers so that they do not interfere with each other. Common leads, however, can be connected to the ground electrode.

**Figure 1. Internal Closed Circuit**

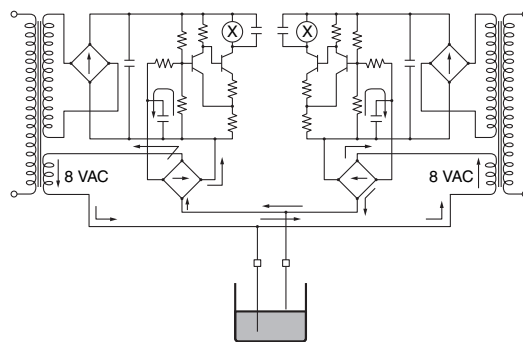

**Figure 2. Match Phases**

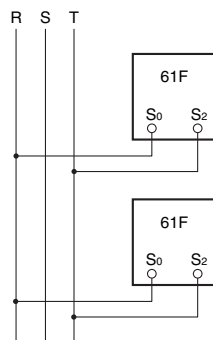



**How long can the sensing band be for a water leak detector? How can you join the bands together?**

1. The following table gives the lengths of sensing bands that are produced.



Model	Individually orderable length	Maximum order length
F03-15	● 100 max. in increments of 1 m	Same as at left
F03-16PE	● 50 max. in increments of 1 m	*100 m/reel
F03-16PT	* 20 max. in increments of 1 m	Same as at left

●: Standard production, \*: Produced upon order

The possible lengths of sensor cable for a Water Leak Detector (61F-GPN-V50) for different lengths of Sensing Bands (F03-15, -16PE, -16PT) are shown below, where the reset current is set at a minimum of 0.15 mA. When the leakage current of the sensing band set to more than 0.15 mA, the water leak detector cannot reset. When the leakage current of the Sensing Band is less than 0.15 mA, the corresponding cable length is okay.

**Possible Length of Sensor Cable (Sensing Band + IV Cable)**

(Unit: mA)

IV cable \ Sensing Band	0 m	10 m	50 m	100 m	150 m	200 m	250 m	300 m	350 m	400 m
0 m		○	○	○	○	○				
10 m	○	○	○	○	○	○				
50 m	○	○	○	○	○	○				
100 m	○	○	○	○	○	○				
150 m	○	○	○	○	○	○				
200 m	○	○	○	○	○	○				
250 m	○	○	○	○	○	○				
300 m	○	○	○	○	○	○				
350 m	○	○	○	○	○	○				
400 m	○	○	○	○	○	○				

Usable range ←

○: Cable lengths that can be used

Note: IV cable (2 mm<sup>2</sup>), Sensing Band (F03-15, F03-16PE)

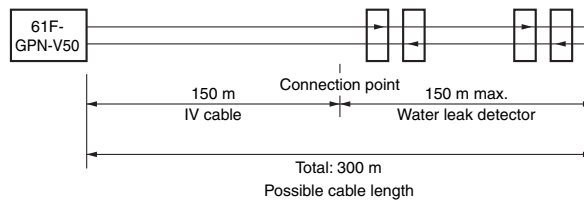

2. The sensing bands can be joined together with the following steps.

**Connecting Water Leak Detector Sensing Bands**

• **F03-15 Sensing Band**

(1) Connecting the Sensing Band Directly to the Water Leak Detector

Strip away about 8 to 10 mm of the sheath from the end of the sensing band.

Figure 1

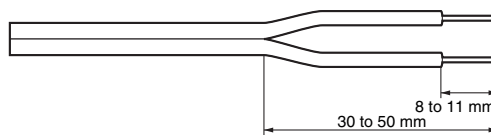

(2) Connecting the Sensing Bands Together

Connect the sensing bands using an insulated crimp sleeve or a closed end connector. Install a pull box (e.g., plastic) and keep the connected section inside it to keep it well insulated. If a pulling box cannot be installed, wrap some insulation tape around the connected section to keep it well insulated. When using a closed end connector, select cables that are similar in size and stiffness to the sensing cable. If a dissimilar cable must be connected, twist the more flexible cable around the stiff cable and use the closed end connector as a standoff connector. If required, remove any electrodes that are attached in close proximity to the connected section.

Figure 2

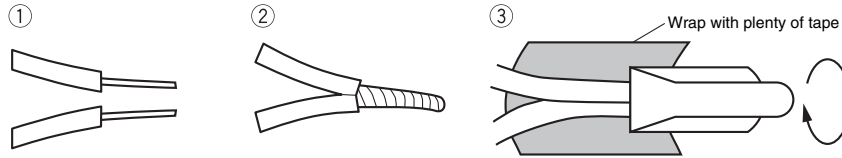

After putting the closed end connector over the joined section, pull the cable and wrap insulation tape around it.

Note

Use AMP Closed end connector, product number 35653 or equivalent.

• F03-16PE Sensing Band

A standard F03-16PE sensing band is made from 0.3 × 1.5 rectangular lines.

(1) Connecting the Sensing Band Directly to the Water Leak Detector

Strip away about 8 to 10 mm of the sheath from the end of the sensing band and then connect it.

Figure 3

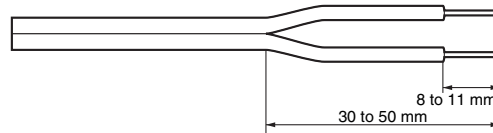

(2) (Connecting the Sensing Bands Together (Using Crimp Sleeve P-1.25 or B-1.25)

Note: P-1.25 and B-1.25 are JIS titles for general electrical wiring.

- (a) Cut a slit in the center of the sensing band with a utility knife. Leave the insulation intact on the inside.
- (b) Strip back the insulation so that the enough wire is exposed to fit into the sleeve in the configuration shown in Figure 7.
- (c) Pull the sleeve over the wires and crimp in the directions shown in Figure 5 and Figure 8. Pull on the wire to check whether the crimping is effective.
- (d) Wrap each connection with insulation tape, then bend the connected sections in opposite directions as shown in Figure 6. Wrap the whole section with insulation tape for protection (see Figure 6).

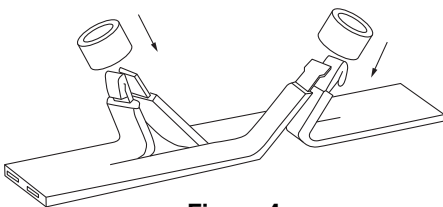

Figure 4

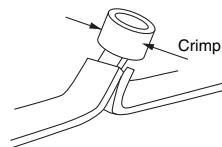

Figure 5

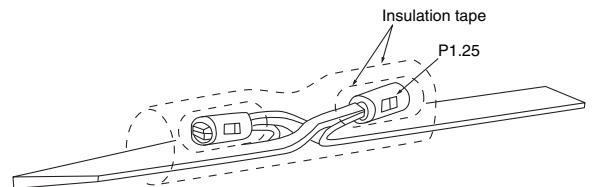

Figure 6

(3) The sensing bands can also be connected by inserting them from opposite ends of sleeve.

As shown in Figure 9, the sensing bands can be inserted from opposite ends of the crimp sleeve to meet in the middle. Either P-1.25 or B-1.25 crimp sleeves can be used but make sure that the crimped section is big enough to fit three folds of the cable conductors.

Crimp in the directions as shown in Figure 5 and Figure 8.

Wrap each connection with insulation tape, then wrap the whole section with insulation tape again for protection.

(4) Connecting the Sensing Band and Lead Wires

Connect the sensing band and lead wires using the method described in the previous item (3). Use a B-1.25 crimp sleeve. (Refer to Figure 9.)

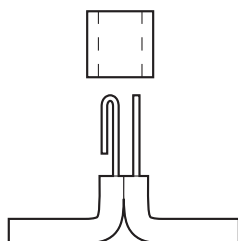

Figure 7

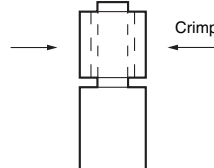

Figure 8

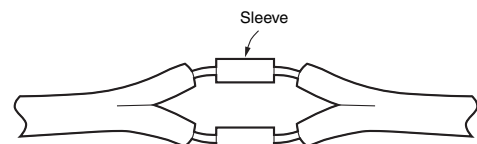

Figure 9

Wiring

**?** The diagrams in the product catalogs always show the long electrode (common electrode) connected to ground. What is the reason for that?

There are two reasons for connecting to ground.

1. To prevent false detection.
2. To provide protection from surges.

The 61F Level Controllers operate on very small currents (2 mA or less for short circuits at 8 VAC) so if the ground is left floating it is susceptible to induction, hence false operation. (Refer to Page 26.)



When using the 61F-03B/-04B, if the circuit is not grounded properly, it will not be effective in suppressing surges.

FRP water tanks are becoming more common in recent times, so it is often connected to the ground terminal of 61F Level Controller.

**?** I want to use an iron tank without using a ground electrode.



If the ground electrode line is connected to the tank, then there is no problem. In some cases, however, the tank has insulation coating on its internal walls, so make sure that you check in advance that the system operates correctly.

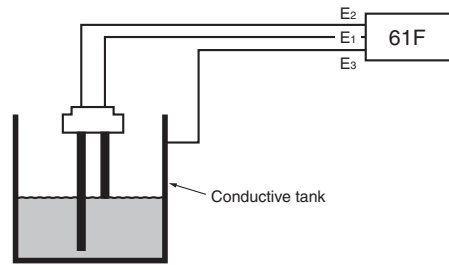

- Comment**
1. If you measure the potential difference between the electrodes when the Level Controller is disconnected, you may find that there is a few volts difference, even though theoretically there should be no difference. For example, if the potential difference was measured to be 3 V, when the common line is connected to ground, this voltage will drop down to as low as 0.5 V, getting rid of any false readings.
  2. Depending on the installation, the ground source may be floating and induce noise from other devices through the ground. If this unlikely situation occurs, establish a proper ground or try floating the 61F ground.

Relay Unit

**?** I want to control the level of purified water.

Consider the conductance and specific resistance when selecting the appropriate Level Controller model. To be accurate, measure the inter-electrode resistance. If the measured value is within the specified range of operate resistance for a particular Level Controller model, it means that the Level Controller can be used. The measurable resistance range of multi-meters is for DC voltage applications, so the inter-electrode resistance cannot be measured accurately. Make sure that AC voltage is used when making measurements. (Refer to page 31)



The conductance can be used as a guide for selecting Level Controller models as shown below.

		Operate resistance
0.5 to 2 $\mu$ S	→ 61F-UHS	0 to 1 M $\Omega$
2 to 5 $\mu$ S	→ 61F-GP-NH3	0 to 200 k $\Omega$
5 to 10 $\mu$ S	→ 61F-GH	0 to 70 k $\Omega$
	61F-GP-NH	0 to 40 k $\Omega$
	61F-GPN-V50	0 to 50 k $\Omega$
15 to 25 $\mu$ S	→ Standard Level Controller	

Note

1. The Ultra-high-sensitivity 61F-HSL Level Controller uses DC current in the electrodes. This causes electrolytic corrosion, making this Level Controller not appropriate in applications where the electrodes are constantly submerged in water. Its usage is limited to abnormal water level indication and water leak detection (e.g., upper-limit indication alarm, tank over flow detection).
2. For purified water higher than 1 MW (some are as high as 18 MW), use the K7L.

**?** What precautions are required when controlling hot water?



Hot water generates steam and water condensation on the connections between Electrode Holders and electrodes. If the water condensation causes a short circuit between electrodes, the Level Controller may experience a reset error regardless of the water level. To prevent this situation, use single-pole Electrode Holders (BF-1, BS-1, BS-1T) to separate the distance between the electrodes or use a low-sensitivity Level Controller. Make sure that it is operating without any errors before securing the Electrode Holders.

**? Which is the best Level Controller model as input to PLCs?  
Is it better if it has single output?**



The 61F-GP-N is recommended. One input has SPDT output.  
Output contact capacity (minimum applicable load):  
1 mA at 5 VDC (reference value)

**Minimum Applicable Load for Different Types of Units**

Standard model .....	1 mA at 5 VDC
Compact model.....	1 mA at 5 VDC
	(Manufactured in August 1999 or later)
Plug-in model.....	1 mA at 5 VDC
Compact plug-in model.....	1 mA at 5 VDC
High-sensitivity 61F-UHS.....	1 mA at 5 VDC
Variable High-sensitivity 61F-HSL .....	1 mA at 5 VDC

**Note:** These values may change when designs are revised. Contact your OMRON representative for details.

**Note** Some pump control panels at the waterworks are equipped with many 61F-GP-N Level Controllers.

**Comment** The 61F-GP-N has a SPDT output, so any unused contact can be used in parallel, increasing the efficiency and reliability. Also, if a self-holding circuit is not required, two outputs can be used individually.

**? How does the two-wire 61F-□□ Level Controller work?**



The self-holding circuit is removed to eliminate one line between the 61F Level Controller and the electrodes.

**Note**

1. Even though it is called a two-wire Level Controller, there can be more than two lines as for the 61F-G3N (5 lines) and the 61F-G3NR (4 lines).
2. Electrode Holders also have R types.

**Comment** The 6.8 kΩ of the electrode and 3.9 kΩ of the 61F are in series. If water level rises so that E<sub>2</sub> is submerged, there is still 6.8 kΩ + 3.9 kΩ = 10.7 kΩ resistance, so the Level Controller will not operate.

When the water level reaches E<sub>1</sub>, the resistance drops to 3.9 kΩ. The Level Controller will trigger the internal relay contacts. If the water level now drops below E<sub>1</sub>, E<sub>2</sub> sees only 6.8 kΩ to the 61F contact, so it can hold the value. The function of the third electrode is thus maintained.

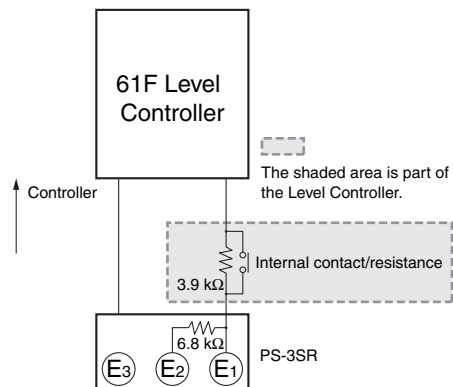



**When operating two pumps alternately using the 61F-G4N and 61F-AN together, what should I do to make the two pumps run simultaneously when the water level falls below E<sub>7</sub> and stops when it reaches E<sub>5</sub>?**

One suggestion is to add a 61F-GN for operating the pumps simultaneously. See the diagram below.

Point 1: Match power supply phases of all the 61F devices.

Point 2: Only the grounded electrode can be shared.

Point 3: Cut electrode E<sub>1</sub> of 61F-GN to the same length as E<sub>5</sub> of 61F-G4N.

Point 4: Cut electrode E<sub>2</sub> of 61F-GN to the same length as E<sub>7</sub> of 61F-G4N.

Point 5: Connect the relay output contacts (T<sub>c</sub>), (T<sub>b</sub>) of 61F-GN to the corresponding terminals (T<sub>a1</sub>), (T<sub>b1</sub>) of 61F-AN.

**Note:** The following wiring diagram may not achieve the desired function. Make sure that you check in advance that it operates correctly.

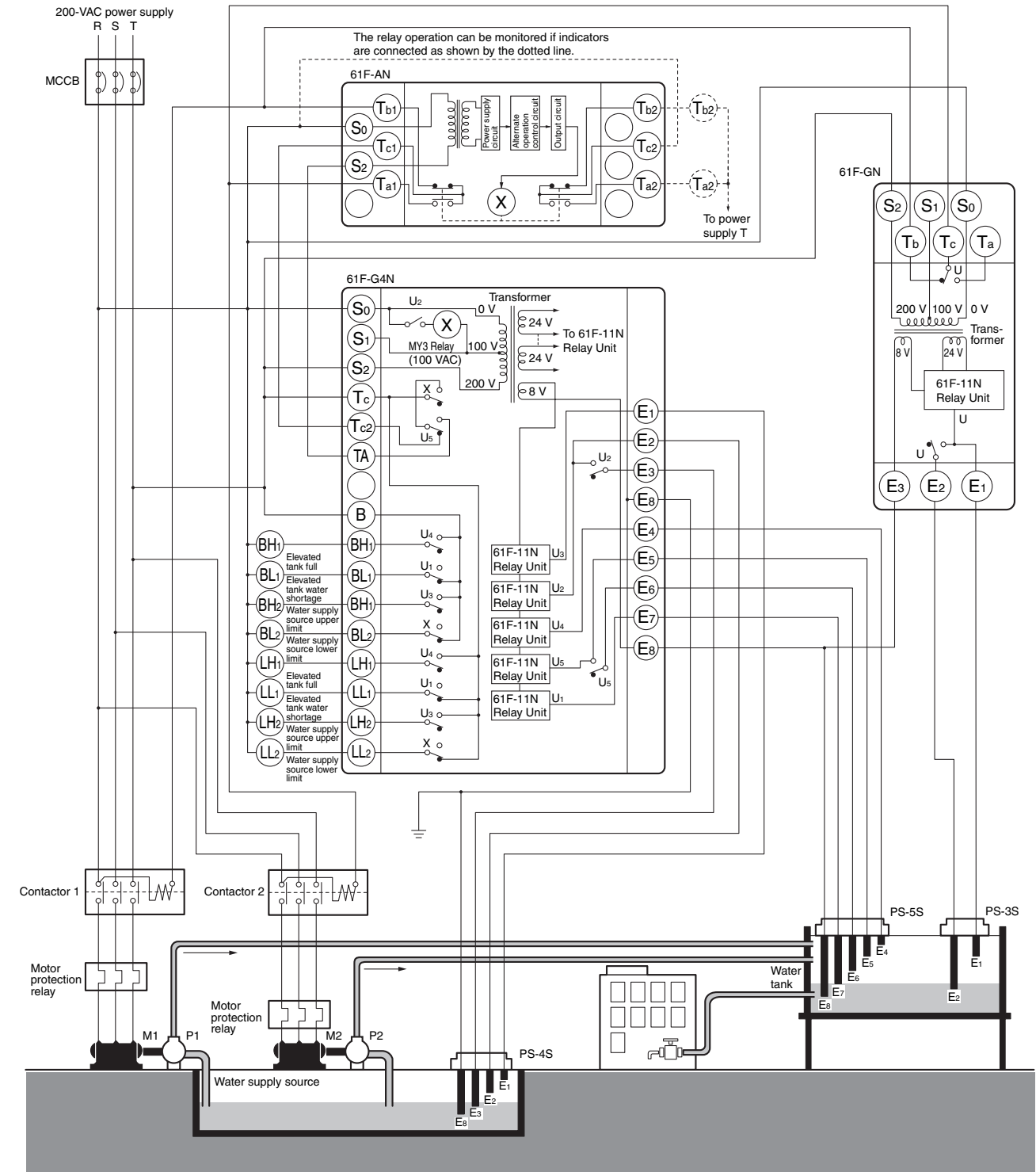

**Note:** Be sure to ground terminal E<sub>8</sub>.

- Sensors
- Switches
- Safety Components
- Relays
- Control Components
- Automation Systems
- Motion / Drives
- Energy Conservation Support / Environment Measure Equipment
- Power Supplies / In Addition
- Others
- Common



## ? How can I connect a float switch to a 61F-GP-N Level Controller.



Connect the float switch contacts to terminals 4 and 5 of the Level Controller. The 61F Level Controllers operate with 8 VAC and only 1 mA flowing between the electrodes, so it is better to use a low-resistance float switch.

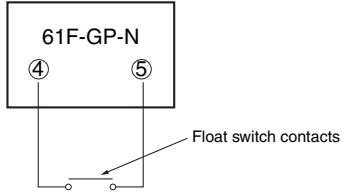

## ? Are there any points to look out for when changing over from the discontinued 61F-GP to the replacement 61F-GP-N8?



The 61F-GP-N8 and 61F-GP differ in outer dimensions so the compatible socket and the mounting method will be different. The terminal arrangement will be reversed so the wiring will have to be changed as well.

### 61F-GP

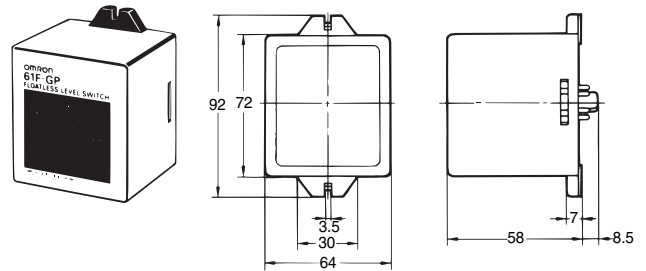

### 61F-GP-N8

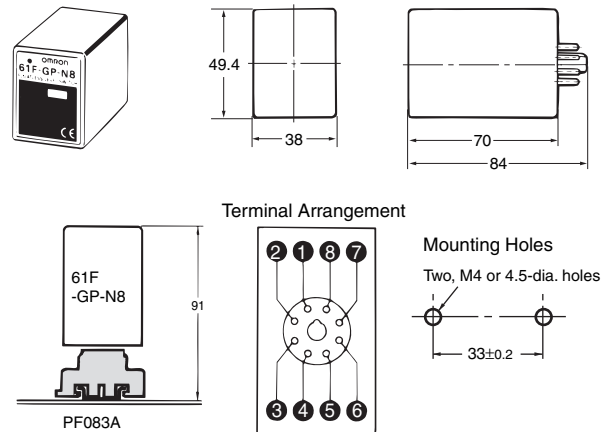

Problems

? There is a small amount of oil mixed in with the water and sometimes the pump doesn't stop. Is this because the electrodes are dirty? Would a high-sensitivity model be better?

Oil floats to the surface of the water and it can cling to the electrodes. When this happens, the electrodes must be cleaned. (Maintenance is required.)

1. Fundamentally oil does not conduct electricity, so a 61F Level Controller that relies on the conductivity of water will not operate properly and should not be used.

Even if it works well at the beginning, when the oil starts to cling to the electrodes, the Level Controller will malfunction.

2. Example Application

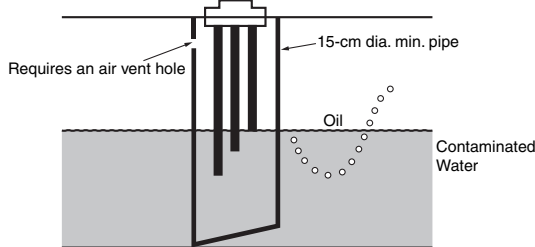

Cut off the end of the pipe at an angle to keep the oil from the electrodes.

? I am using 800 m of 2 mm<sup>2</sup> three-conductor cable for the 61F-G and sometimes the water supply motor doesn't work properly. The catalog indicates that a 0.75 mm<sup>2</sup> cable enables operation for lengths up to 1,000 m so I would have thought that using a 2 mm<sup>2</sup> cable would be ok since it reduces the voltage drop.

Check

Are there any other lines together with the lines for the 61F?

The leakage current to ground will increase when changing from a 0.75 mm<sup>2</sup> cable to a 2 mm<sup>2</sup> cable. The problem is not the voltage drop but the effect of induction through ground. The motor is not working properly due to a reset fault. There may be induced voltage causing a problem. Use 61F-11L 2KM Relay Unit.



Comment

Many people think that voltage drop is the problem; however, the 61F uses very small currents so voltage induction is a bigger concern. Unlike a voltage drop, induction combines the effect from all the connected lines. If 30 conductors are connected and even if not all of the lines are used, all of them contribute to the effect. If any of these lines are 100 VAC or 200 VAC lines, then even more so. Make sure that they are wired separately. (Using shielded cables for the electrode lines can also be effective.)

The bigger the diameter of the cable, the bigger its capacitance to ground, and bigger the leakage current. This leakage current can cause reset faults and the Level Controller may malfunction even when the electrodes are not conducting any current. Leakage current varies significantly depending on the cable length.

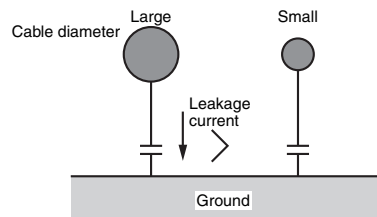

Maintenance

? It seems that the sensitivity has dropped because the electrodes are dirty. How should I clean them?

If there is any rust on the electrodes, it will not conduct properly. Use sand paper to remove it. Use a cloth to wipe off any lime deposits.



The electrodes are stainless, so commercial chemicals can be used for cleaning but make sure that they don't affect the liquid inside the tank.

If the electrodes are in a very bad condition, replace them with new ones.

## Troubleshooting

### Basic Concepts

Any problems with the 61F can be categorized into one of three areas. (See diagram on right.)

To find out which area is causing the problem, simulate a change in water level by using a clip or a piece of wire to create a short circuit between the electrodes. By closing and opening the circuit you can compare it with normal operating behavior. (Do not short circuit the power supply terminals.)

For example, for the 61F-GN, check that the electrodes are not submerged in water, then see what happens when terminals E<sub>1</sub> to E<sub>3</sub> are short circuited. Check that it resets when the short circuit is removed. If there are no problems, then conduct the same test at the terminals of the Electrode Holder, thereby finding the problematic section by process of elimination.

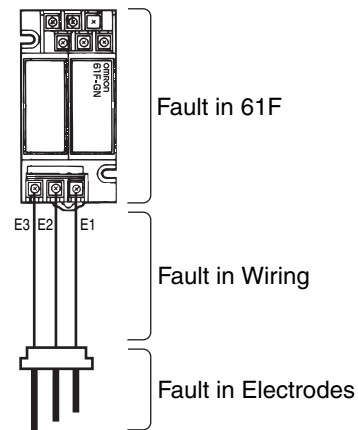

### Flowcharts

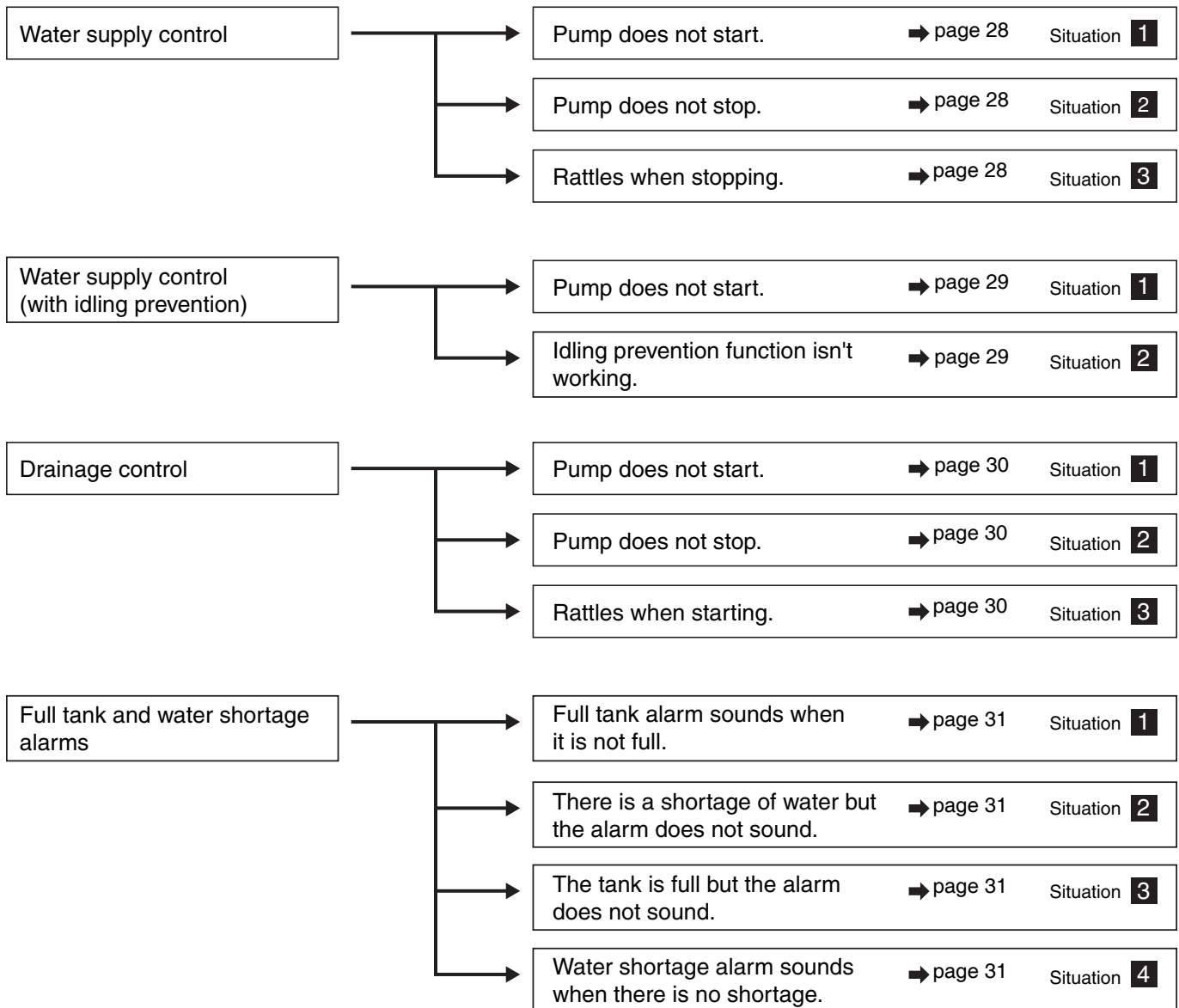

### Water Supply Control Troubleshooting

Situation	Items to check	Cause and Solution							
<b>1</b> <b>Pump does not start.</b>	1. Is power applied to the contact and power supply terminals? 2. Is the power supply (same phase) connected to one end of the magnetic contact switch coil and So terminal of 61F? 3. Are the contact and power supply terminals screwed on properly? 4. Is the motor protection relay activated? 5. Are the electrodes in the table below touching each other, in contact with the tank or tangled with any objects?	1. Check the fuse and no-fuse breakers. 2. Check that the wiring of the output relay and the magnetic contact coil is correct. 3. If it is loose, tighten it. 4. If it has operated, remove the cause and reset. 5. Install it correctly and if there is something tangled on it, remove it. 6. If there is a fault, replace the wires. 7. If long wires are needed, use a long-distance Level Controller (61F-□NL (-□L) 2 km or 4 km). If the interference is due to inductance, use shielded wires or change the wiring.							
	<table border="1" style="width:100%; border-collapse: collapse;"> <tr> <th style="width:33%;">61F-GN(G), 61F-G1N(G1)</th> <th style="width:33%;">61F-G3N(G3)</th> <th style="width:33%;">61F-G4N(G4)</th> </tr> <tr> <td>E<sub>1</sub> to E<sub>3</sub> or E<sub>2</sub> to E<sub>3</sub></td> <td>E<sub>2</sub> to E<sub>5</sub> or E<sub>3</sub> to E<sub>5</sub></td> <td>E<sub>5</sub> to E<sub>8</sub> or E<sub>6</sub> to E<sub>8</sub></td> </tr> </table> 6. Are there insulation problems with wiring of any of the following electrode circuits?		61F-GN(G), 61F-G1N(G1)	61F-G3N(G3)	61F-G4N(G4)	E <sub>1</sub> to E <sub>3</sub> or E <sub>2</sub> to E <sub>3</sub>	E <sub>2</sub> to E <sub>5</sub> or E <sub>3</sub> to E <sub>5</sub>	E <sub>5</sub> to E <sub>8</sub> or E <sub>6</sub> to E <sub>8</sub>	
61F-GN(G), 61F-G1N(G1)	61F-G3N(G3)	61F-G4N(G4)							
E <sub>1</sub> to E <sub>3</sub> or E <sub>2</sub> to E <sub>3</sub>	E <sub>2</sub> to E <sub>5</sub> or E <sub>3</sub> to E <sub>5</sub>	E <sub>5</sub> to E <sub>8</sub> or E <sub>6</sub> to E <sub>8</sub>							
<b>2</b> <b>Pump does not stop.</b>	If the Level Controller stops when terminals of the following are short circuited, the problem could be any from 1 to 6.	1. Put it in properly and tighten if loose. 2. Replace if faulty. Tighten terminal screws. 3. If there are lime deposits or grease, it will not conduct well, so remove it and clean. 4. If the electrodes are too far apart, the inter-electrode resistance becomes too high and 61F will not operate properly. 5. If the specific resistance is high, replace with a high-sensitivity Level Controller (61F-□NH (-□H).) 6. If tape is wrapped around for protection, leave at least 10 cm of the end uncovered.							
	<table border="1" style="width:100%; border-collapse: collapse;"> <tr> <th style="width:33%;">61F-GN(G), 61F-G1N(G1)</th> <th style="width:33%;">61F-G3N(G3)</th> <th style="width:33%;">61F-G4N(G4)</th> </tr> <tr> <td>E<sub>1</sub> to E<sub>3</sub> terminals</td> <td>E<sub>2</sub> to E<sub>5</sub> terminals</td> <td>E<sub>5</sub> to E<sub>8</sub> terminals</td> </tr> <tr> <td>E<sub>1</sub>*</td> <td>E<sub>2</sub>*</td> <td>E<sub>5</sub>*</td> </tr> </table> 1. Have any of the electrodes marked with * fallen Off or becoming loose? 2. Are any of the electrode lead wires marked with * disconnected or have loose terminal screws? 3. Are there any lime deposits or grease on the electrodes? 4. Is the distance between the electrodes appropriate? 5. Is the specific resistance of the liquid (water) too high? 6. Is tape wrapped around the electrodes right to the end?		61F-GN(G), 61F-G1N(G1)	61F-G3N(G3)	61F-G4N(G4)	E <sub>1</sub> to E <sub>3</sub> terminals	E <sub>2</sub> to E <sub>5</sub> terminals	E <sub>5</sub> to E <sub>8</sub> terminals	E <sub>1</sub> *
61F-GN(G), 61F-G1N(G1)	61F-G3N(G3)	61F-G4N(G4)							
E <sub>1</sub> to E <sub>3</sub> terminals	E <sub>2</sub> to E <sub>5</sub> terminals	E <sub>5</sub> to E <sub>8</sub> terminals							
E <sub>1</sub> *	E <sub>2</sub> *	E <sub>5</sub> *							
<b>3</b> <b>Rattles when stopping.</b>	1. Have any of the electrodes marked with the * fallen off or becoming loose? 2. Are any of the electrode circuits lead wires marked with * disconnected or have loose terminal screws?	If electrodes marked with * are not working properly, it becomes a single point control and switches the device ON, OFF with just a small amount of variation in water level.							
	<table border="1" style="width:100%; border-collapse: collapse;"> <tr> <th style="width:33%;">61F-GN(G), 61F-G1N(G1)</th> <th style="width:33%;">61F-G3N(G3)</th> <th style="width:33%;">61F-G4N(G4)</th> </tr> <tr> <td>E<sub>2</sub>*</td> <td>E<sub>3</sub>*</td> <td>E<sub>6</sub>*</td> </tr> </table> 3. Is there a mistake with the wiring of the electrodes shown in the following table?		61F-GN(G), 61F-G1N(G1)	61F-G3N(G3)	61F-G4N(G4)	E <sub>2</sub> *	E <sub>3</sub> *	E <sub>6</sub> *	
61F-GN(G), 61F-G1N(G1)	61F-G3N(G3)	61F-G4N(G4)							
E <sub>2</sub> *	E <sub>3</sub> *	E <sub>6</sub> *							
	<table border="1" style="width:100%; border-collapse: collapse;"> <tr> <th style="width:33%;">61F-GN(G), 61F-G1N(G1)</th> <th style="width:33%;">61F-G3N(G3)</th> <th style="width:33%;">61F-G4N(G4)</th> </tr> <tr> <td>E<sub>1</sub> to E<sub>3</sub></td> <td>E<sub>1</sub> to E<sub>5</sub></td> <td>E<sub>4</sub> to E<sub>8</sub></td> </tr> </table>	61F-GN(G), 61F-G1N(G1)	61F-G3N(G3)	61F-G4N(G4)	E <sub>1</sub> to E <sub>3</sub>	E <sub>1</sub> to E <sub>5</sub>	E <sub>4</sub> to E <sub>8</sub>		
61F-GN(G), 61F-G1N(G1)	61F-G3N(G3)	61F-G4N(G4)							
E <sub>1</sub> to E <sub>3</sub>	E <sub>1</sub> to E <sub>5</sub>	E <sub>4</sub> to E <sub>8</sub>							

**Note:** 1. For devices with idling prevention function, check the items listed in page 29 as well.  
 2. For devices with full tank and water shortage alarm, refer to page 31.  
 3. When using a Level Controller for water supply control and it has a water shortage alarm, if the buzzer sounds but the pump doesn't start when the Level Controller is turned ON, check the water level.  
 If the water level is not reaching electrode E<sub>4</sub>, this phenomenon is the correct outcome for a water shortage alarm.  
 To start the pump in this state, create a short circuit between the electrode circuits E<sub>4</sub> and E<sub>3</sub> until the water level reaches electrode E<sub>4</sub>.  
 Re-check the alarm water level and the length of electrode E<sub>4</sub>.

#### Type of Electrodes

61F-GN(G)	61F-G1N(G1)	61F-G3N(G3)	61F-G4N(G4)		
	<table border="0" style="width:100%;"> <tr> <td style="width:50%; vertical-align: top;"> <b>Situation 1</b>                              Automatic water supply with pump idling prevention   </td> <td style="width:50%; vertical-align: top;"> <b>Situation 2</b>                              Automatic water supply with water shortage alarm   </td> </tr> </table>	<b>Situation 1</b> Automatic water supply with pump idling prevention  	<b>Situation 2</b> Automatic water supply with water shortage alarm  		
<b>Situation 1</b> Automatic water supply with pump idling prevention  	<b>Situation 2</b> Automatic water supply with water shortage alarm  				
	Water supply source		Water supply source		

For connection details, refer to the datasheets of 61F-G□N, 61F-G□, 61-GP-N□, 61F-G□P, and 61F-UHS/-HSL.

Sensors  
 Switches  
 Safety Components  
 Relays  
 Control Components  
 Automation Systems  
 Motion / Drives  
 Energy Conservation Support / Environment Measure Equipment  
 Power Supplies / In Addition  
 Others  
 Common

## Water Supply Control (with Idling Prevention) Troubleshooting

For devices with idling prevention 61F-G1N (G1)/-G4N (G4), conduct the following checks as well.

Situation	Items to check	Cause and Solution
<b>1</b> Pump does not start.	<ul style="list-style-type: none"> <li>Is the idling prevention circuit activated? Make sure that electrodes E<sub>1</sub>, E<sub>2</sub> and E<sub>3</sub> are not too short. (Check E<sub>1</sub>' and E<sub>2</sub>' When using 61F-G1N (G1).)</li> </ul> <ol style="list-style-type: none"> <li>Check the water level of the water supply source. Does the water level reach E<sub>2</sub> (E<sub>1</sub>')?</li> <li>Are either of the electrode E<sub>2</sub>, E<sub>3</sub> (E<sub>1</sub>', E<sub>2</sub>') lead wires broken? Are any of the screws of E<sub>2</sub>, E<sub>3</sub> (E<sub>3</sub>', E<sub>2</sub>') loose?</li> </ol>	<ul style="list-style-type: none"> <li>Unless it is conductive between E<sub>2</sub> (E<sub>1</sub>' when using 61F-G1N/G1) and E<sub>8</sub> (E<sub>3</sub>) when the Level Controller is turned ON, and between E<sub>3</sub> (E<sub>2</sub>') and E<sub>8</sub> (E<sub>3</sub>) after it has been turned ON, the idling prevention function operates and the motor will not move.</li> </ul> <ol style="list-style-type: none"> <li>If the water level is not reaching electrode E<sub>2</sub> (E<sub>1</sub>') when the Level Controller is turned ON, create a short circuit between E<sub>2</sub> and E<sub>8</sub> (E<sub>1</sub>' and E<sub>3</sub>) momentarily to start the motor.</li> </ol>
<b>2</b> Idling prevention function is not working.	<ol style="list-style-type: none"> <li>Are any of the electrodes E<sub>2</sub> and E<sub>8</sub> or E<sub>3</sub> and E<sub>8</sub> (E<sub>1</sub>' and E<sub>3</sub> or E<sub>2</sub>' and E<sub>3</sub>) touching, in contact with the tank, or tangled with any objects?</li> <li>Are there any insulation problems with the lead wires of electrodes E<sub>2</sub> or E<sub>3</sub> (E<sub>1</sub>' or E<sub>2</sub>')?</li> <li>Is the Level Controller malfunctioning because of the long lead wires?</li> </ol>	<ol style="list-style-type: none"> <li>Install it properly and if there is something tangled on it, remove it.</li> <li>If the wires are faulty, replace them.</li> <li>If long wires are needed, use a long-distance Level Controller. If the interference is due to inductance, use shielded wires or change the wiring.</li> </ol>

**Note:** Items in the parentheses are for the 61F-G1N (G1).

### Type of Electrodes

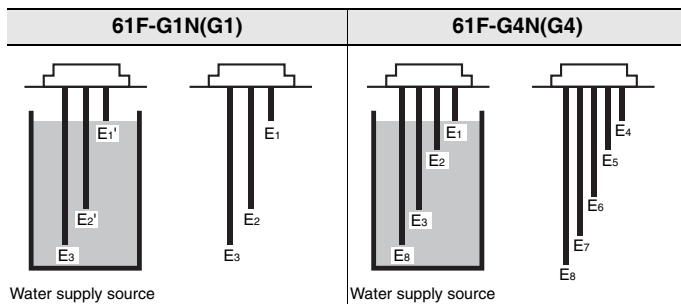

For connection details, refer to the datasheets of 61F-G□N, 61F-G□, and 61F-G□P.

## Drainage Control Troubleshooting

Situation	Items to check	Cause and Solution						
<b>1</b> <b>Pump does not start.</b>	1. Is power applied to the contact and power supply terminals? 2. Is the power supply (same phase) connected to one end of the magnetic contact switch coil and S <sub>0</sub> terminal of 61F? 3. Are the contact and power supply terminals screwed on properly? 4. Is the motor protection relay activated? • If the device starts when terminals shown in the following table are short circuited, the problem could be any one from 5 to 10. <table border="1" style="width: 100%; margin-top: 10px;"> <thead> <tr> <th style="width: 50%;">61F-GN(G), 61F-G2N(G2)</th> <th style="width: 50%;">61F-G3N(G3)</th> </tr> </thead> <tbody> <tr> <td>Between electrodes E<sub>1</sub> and E<sub>3</sub></td> <td>Between electrodes E<sub>2</sub> and E<sub>5</sub></td> </tr> <tr> <td>E<sub>1</sub>*</td> <td>E<sub>2</sub>*</td> </tr> </tbody> </table>	61F-GN(G), 61F-G2N(G2)	61F-G3N(G3)	Between electrodes E <sub>1</sub> and E <sub>3</sub>	Between electrodes E <sub>2</sub> and E <sub>5</sub>	E <sub>1</sub> *	E <sub>2</sub> *	1. Check the fuse and no-fuse breakers. 2. Check that the wiring of the output relay and the magnetic contact coil is correct. 3. If it is loose, tighten it. 4. If it is active, remove the cause and reset. 5. Install it correctly and if there is something tangled on it, remove it. 6. Replace if faulty. Tighten terminal screws. 7. If there is lime deposits or grease, it will not conduct well, so remove it and clean. 8. If the electrodes are too far apart, the inter-electrode resistance becomes too high and 61F will not operate properly. 9. If the specific resistance is high, replace with a high-sensitivity Level Controller (61F-□NH (-□H).) 10. If tape is wrapped around for protection, leave at least 10 cm of the end uncovered.
	61F-GN(G), 61F-G2N(G2)	61F-G3N(G3)						
Between electrodes E <sub>1</sub> and E <sub>3</sub>	Between electrodes E <sub>2</sub> and E <sub>5</sub>							
E <sub>1</sub> *	E <sub>2</sub> *							
5. Are any of the electrode circuits lead wires marked with * in the above table disconnected or have loose terminal screws? 7. Are there any lime deposits or grease on the electrodes? 8. Is the distance between the electrodes appropriate? 9. Is the specific resistance of the liquid (water) too high? 10. Is tape wrapped around the electrodes right to the end?								
<b>2</b> <b>Pump does not stop.</b>	1. Are the electrodes in the table below touching each other, in contact with the tank or tangled with any objects? <table border="1" style="width: 100%; margin-top: 10px;"> <thead> <tr> <th style="width: 50%;">61F-GN(G), 61F-G2N(G2)</th> <th style="width: 50%;">61F-G3N(G3)</th> </tr> </thead> <tbody> <tr> <td>Between E<sub>1</sub> and E<sub>3</sub> or E<sub>2</sub> and E<sub>3</sub></td> <td>Between E<sub>2</sub> and E<sub>5</sub> or E<sub>3</sub> and E<sub>5</sub></td> </tr> </tbody> </table>	61F-GN(G), 61F-G2N(G2)	61F-G3N(G3)	Between E <sub>1</sub> and E <sub>3</sub> or E <sub>2</sub> and E <sub>3</sub>	Between E <sub>2</sub> and E <sub>5</sub> or E <sub>3</sub> and E <sub>5</sub>	1. Install it correctly and if there is something tangled on it, remove it.  2. If there is a fault, replace the wires.  3. If long wires are needed, use a long-distance Level Controller (61F-□NL (-□L) 2 km or 4 km). If the interference is due to inductance, use shielded wires or change the wiring.		
	61F-GN(G), 61F-G2N(G2)	61F-G3N(G3)						
Between E <sub>1</sub> and E <sub>3</sub> or E <sub>2</sub> and E <sub>3</sub>	Between E <sub>2</sub> and E <sub>5</sub> or E <sub>3</sub> and E <sub>5</sub>							
2. Are there any insulation problems with the lead wires of any of the following electrodes? <table border="1" style="width: 100%; margin-top: 10px;"> <thead> <tr> <th style="width: 50%;">61F-GN(G), 61F-G2N(G2)</th> <th style="width: 50%;">61F-G3N(G3)</th> </tr> </thead> <tbody> <tr> <td>E<sub>1</sub>, E<sub>2</sub> circuits</td> <td>E<sub>2</sub>, E<sub>3</sub> circuits</td> </tr> </tbody> </table>	61F-GN(G), 61F-G2N(G2)	61F-G3N(G3)	E <sub>1</sub> , E <sub>2</sub> circuits	E <sub>2</sub> , E <sub>3</sub> circuits				
61F-GN(G), 61F-G2N(G2)	61F-G3N(G3)							
E <sub>1</sub> , E <sub>2</sub> circuits	E <sub>2</sub> , E <sub>3</sub> circuits							
<b>3</b> <b>Rattles when starting.</b>	<table border="1" style="width: 100%; margin-bottom: 10px;"> <thead> <tr> <th style="width: 50%;">61F-GN(G), 61F-G2N(G2)</th> <th style="width: 50%;">61F-G3N(G3)</th> </tr> </thead> <tbody> <tr> <td>E<sub>2</sub>*</td> <td>E<sub>3</sub>*</td> </tr> </tbody> </table>	61F-GN(G), 61F-G2N(G2)	61F-G3N(G3)	E <sub>2</sub> *	E <sub>3</sub> *	If electrodes marked with * are not working properly, it becomes a single point control and switches the device ON, OFF with just a small amount of variation in water level.		
	61F-GN(G), 61F-G2N(G2)	61F-G3N(G3)						
E <sub>2</sub> *	E <sub>3</sub> *							
1. Are any of the electrodes marked with * fallen off or coming loose? 2. Are any of the electrode circuits lead wires marked with * in the above table disconnected or have loose terminal screws? 3. Are the contactor or 61F terminals screws coming loose? 4. Is there a mistake with the wiring of the electrodes shown in the following table?								

**Note:** For devices with full tank and water shortage alarm, refer to page 31.

### Type of Electrodes

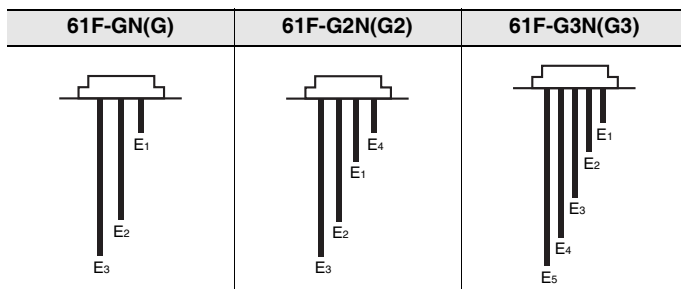

For connection details, refer to the datasheets of 61F-G□N, 61F-G□, 61-GP-N□, 61F-G□P, and 61F-UHS/-HSL.

## Troubleshooting for Full Tank and Water Shortage Alarms

The following table provides specific check points for each model for various problems and check items.

Problem	Check items	61F-G1N(G1)	61F-G2N(G2)	61F-G3N(G3)	64F-G1N(G4)
<b>1</b> Full tank alarm sounds when the tank is not full.	<ol style="list-style-type: none"> <li>Are the electrodes touching each other, in contact with the tank, or tangled with any objects?</li> <li>Are there insulation problems with the wiring of any of the following electrode circuits?                             <ul style="list-style-type: none"> <li>With long leads to the electrodes (between electrode holders and the 61F), is there any interference from electrostatic capacitance or electromagnetic inductance?</li> </ul> </li> </ol>	---	<ol style="list-style-type: none"> <li>E<sub>4</sub> and other electrodes (See note.)</li> <li>E<sub>4</sub></li> </ol>	<ol style="list-style-type: none"> <li>E<sub>1</sub> and other electrodes (See note.)</li> <li>E<sub>1</sub></li> </ol>	Elevated tank <ol style="list-style-type: none"> <li>E<sub>4</sub> and other electrodes (See note.)</li> <li>E<sub>4</sub></li> </ol> Water supply source <ol style="list-style-type: none"> <li>E<sub>1</sub> and other electrodes (See note.)</li> <li>E<sub>1</sub></li> </ol>
<b>2</b> There is a shortage of water but the alarm does not sound.	<ol style="list-style-type: none"> <li>If shorting the terminals listed under 1 for each 61F model restored normal operation, then the problem is one the following.</li> <li>Are any of the electrodes that have fallen off or come loose?</li> <li>Are any of the electrode leads disconnected or have any of the terminals listed under 4 for each 61F model come loose?</li> </ol>	<ol style="list-style-type: none"> <li>E<sub>4</sub> and E<sub>3</sub></li> <li>E<sub>4</sub></li> </ol>	---	<ol style="list-style-type: none"> <li>E<sub>4</sub> and E<sub>5</sub></li> <li>E<sub>4</sub></li> </ol>	Elevated tank <ol style="list-style-type: none"> <li>E<sub>7</sub> and E<sub>8</sub></li> <li>E<sub>7</sub></li> </ol> Water supply source <ol style="list-style-type: none"> <li>E<sub>3</sub> and E<sub>8</sub></li> <li>E<sub>3</sub></li> </ol>
<b>3</b> The tank is full but the alarm does not sound.	<ul style="list-style-type: none"> <li>Are there any lime deposits or grease on the electrodes?</li> <li>Are the electrodes too far apart?</li> <li>Is the specific resistance of the liquid (water) too high?</li> <li>Is tape wrapped around the electrodes right to the end?</li> </ul>	---	<ol style="list-style-type: none"> <li>E<sub>4</sub> and E<sub>3</sub></li> <li>E<sub>4</sub></li> <li>E<sub>4</sub></li> <li>E<sub>4</sub>, E<sub>3</sub></li> </ol>	<ol style="list-style-type: none"> <li>E<sub>1</sub> and E<sub>5</sub></li> <li>E<sub>1</sub></li> <li>E<sub>1</sub></li> <li>E<sub>1</sub>, E<sub>5</sub></li> </ol>	Elevated tank <ol style="list-style-type: none"> <li>E<sub>4</sub> and E<sub>8</sub></li> <li>E<sub>4</sub></li> <li>E<sub>4</sub></li> <li>E<sub>1</sub>, E<sub>8</sub></li> </ol> Water supply source <ol style="list-style-type: none"> <li>E<sub>1</sub> and E<sub>8</sub></li> <li>E<sub>1</sub></li> <li>E<sub>1</sub></li> <li>E<sub>1</sub>, E<sub>8</sub></li> </ol>
<b>4</b> Water shortage alarm sounds when there is no shortage.	<ul style="list-style-type: none"> <li>Are there any lime deposits or grease on the electrodes?</li> <li>Are the electrodes too far apart?</li> <li>Is the specific resistance of the liquid (water) too high?</li> <li>Is tape wrapped around the electrodes right to the end?</li> </ul>	<ol style="list-style-type: none"> <li>E<sub>1</sub>' (E<sub>4</sub>) and E<sub>3</sub></li> <li>E<sub>4</sub></li> <li>E<sub>4</sub></li> <li>E<sub>1</sub>' (E<sub>4</sub>), E<sub>3</sub></li> </ol>	---	<ol style="list-style-type: none"> <li>E<sub>4</sub> and E<sub>5</sub></li> <li>E<sub>4</sub></li> <li>E<sub>4</sub></li> <li>E<sub>4</sub>, E<sub>5</sub></li> </ol>	Elevated tank <ol style="list-style-type: none"> <li>E<sub>7</sub> and E<sub>8</sub></li> <li>E<sub>7</sub></li> <li>E<sub>7</sub></li> <li>E<sub>7</sub>, E<sub>8</sub></li> </ol> Water supply source <ol style="list-style-type: none"> <li>E<sub>3</sub> and E<sub>8</sub></li> <li>E<sub>3</sub></li> <li>E<sub>3</sub></li> <li>E<sub>3</sub>, E<sub>8</sub></li> </ol>

**Note:** Even if the alarm electrode has no contact with the common electrode, it becomes conductive when it can come into contact with any other electrodes when the water level rises.

### Inspecting the Electrode Circuits

If the electrodes cannot be withdrawn to test the electrode circuit, a tester can be used to measure the resistance between the electrode and ground, as shown in the diagram on the right. The measured resistance value indicates the length, contact condition, and mounting condition of the electrode.

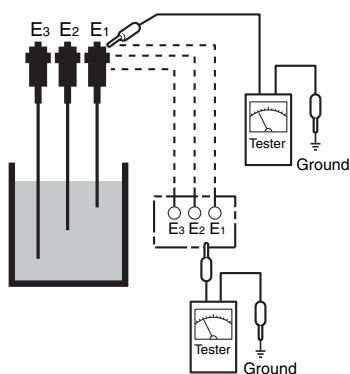

For example, the sequence of electrodes ordered from low measured resistance to high is E<sub>3</sub> (long), E<sub>2</sub> (medium), and E<sub>1</sub> (short). Follow the guidelines below to use this test method.

- Detach the leads from the 61F.
- Measure the conducting status with the tank full. (The water level must be at E<sub>1</sub> or higher.)
- Measure the insulating status with the tank empty. (The water level must be at E<sub>2</sub> or lower.)

### Measuring the Resistance between Electrodes

Measure the resistance between the electrodes if the wiring is correct but the 61F does not operate. Measure with a voltmeter using the voltage drop method, as shown on the right.

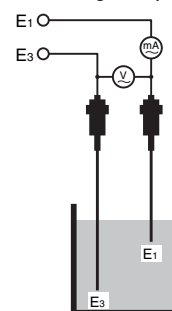

The resistance between electrodes (resistance of liquid between E<sub>1</sub> and E<sub>3</sub>) is given by the following equation.

$$R = \frac{V}{I}$$

R: Resistance of liquid between electrodes (kΩ)  
 V: Voltmeter indicated voltage (V)  
 I: Ammeter indicated current (mA)

- An ammeter able to read approximately 1 mA with as low an impedance as possible.
- A voltmeter able to read a value of several volts with as high an impedance as possible.

Select the 61F model according to the R (resistance) value.

### Inspecting the 61F-11N Relay Unit

Apply the specified power supply voltage with the Relay Units connected to the 61F. Refer to the connection diagrams (internal wiring diagrams) and short the 61F ground terminal to the operating terminal of each Relay Unit. Check the operation of the relay output contacts with a tester. With the 61F-11, the indicator will be lit when the Relay Unit operates.