

Introduction

What Is a Liquid Leakage Sensor?

A Liquid Leakage Sensor is a sensor that detects leakage of chemical liquids and pure water.

Application Examples

Detection of Condensation and Liquid Leakage at Semiconductor Production Installations

Detection is also possible for condensation inside cleaning devices and liquid leaked to the surroundings.



Detection of Liquid Leakage at Pipe Joints for Liquid Chemical Tanks

Liquid leakage at a pipe joint can be detected by wrapping the Sensing Band around the joint.



Detection of Cleaning Fluid Level for Plating Devices

The level of pure water is detected inside plating baths. High sensitivity allows high-accuracy control to prevent cleaning irregularities.

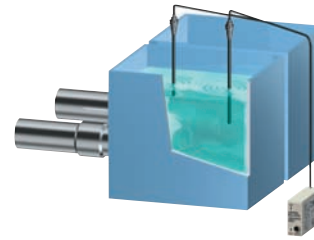

Note: Be sure to ground the baths if two or more K7L Sensors are used in the same tank in an explosion-prevention area.

Liquid Leakage Detection for Measuring Baths in CMP Devices

Liquid leaked to drain pans can be detected to prevent damage to devices and cleaning irregularities for wafers.

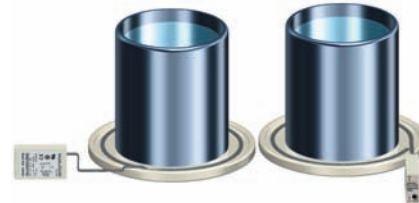

Features

The features of OMRON Liquid Leakage Sensors and the K7L Liquid Leakage Sensor Amplifiers are described below.

1. Inter-electrode Resistance Detection

Stable detection of liquids with impedances of up to 50 MΩ and common water. Four sensing ranges are available, ensuring detection suited to the application.

(For the K7L-AT50/AT50D.)



Fresh water, pure water, distilled water, plating liquids, chemical liquids, IPA (isopropyl alcohol)

2. AC Detection Method

The K7L internally oscillates AC signals provided to the Sensing Band, protecting the Sensing Band from electric corrosion and ensuring safe operation.

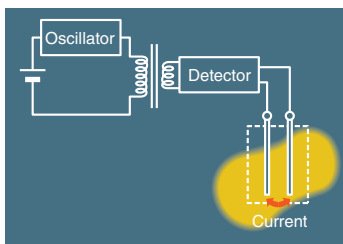

3. Noise Canceller Function

The K7L incorporates a noise canceller circuit that uses a 3-conductor cable, ensuring a high level of noise immunity.

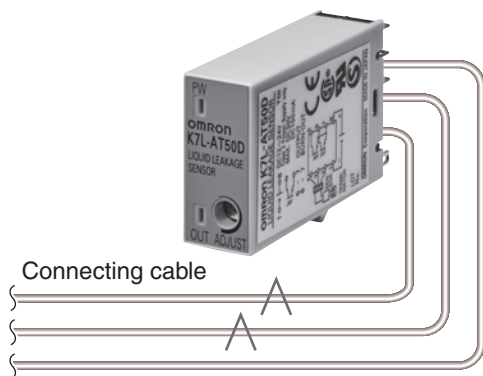

4. Multiple Installation

The power supply circuit and the detection circuit are isolated, allowing several Amplifiers to be installed in the same place.

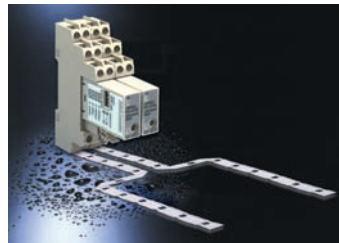

5. Sensing Band with Excellent Chemical Resistance

SUS316 and polyethylene are used for the Sensing Band's core and sheath to ensure high resistance to both acidic and alkaline liquids.

Fluoroplastic Sensing Bands are also available and they have higher resistance to both high temperatures and chemicals compared the polyethylene Sensing Bands.

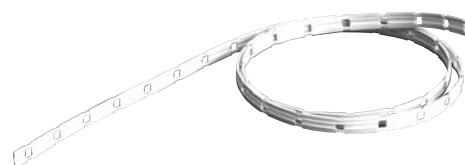

6. Helps to downsize gang-mounted panels.

The extremely compact size, with a width of only 16 mm, helps to save panel size when mounting several Units together.

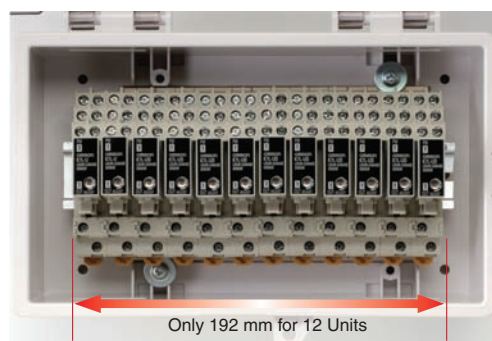

(*At an ambient operating temperature of -10 to 55°C.)

Operating Principles

With the inter-electrode resistance detection, when liquid makes contact with the two electrodes on the Liquid Leakage Sensing Band (hereafter simply called Sensing Band), current flows through the liquid and the liquid leakage is detected.

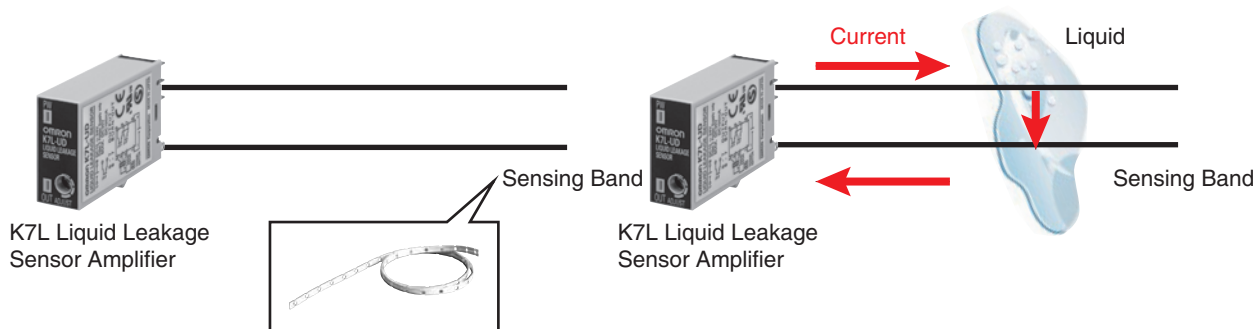

Operation While Monitoring for Liquid Leakage

- Short-wave signals (2.5 VAC, 3.75 Hz) for liquid leakage detection are output from terminal 4 of the K7L.
- When there is no liquid leakage, the liquid leakage detection signals that are output are interrupted by the Terminator and the core of the Sensing Band will form an open loop.

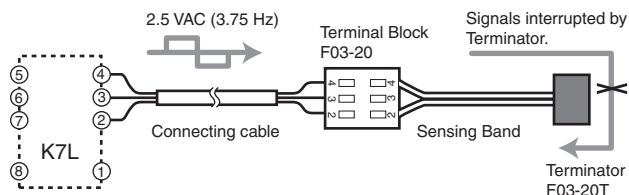

Operation at Liquid Leakage Detection

- When liquid leakage occurs within the sensing range, the liquid leakage detection signals output from terminal 4 are input to terminal 2 through the leaked liquid.
- The voltage of the input signals will vary with the resistance of the leaked liquid. This voltage is compared with the detection level set at the K7L.
- As a result of the comparison, if the K7L determines that liquid leakage has occurred, the K7L's output LED will light, and the liquid detection output will either turn ON or OFF.

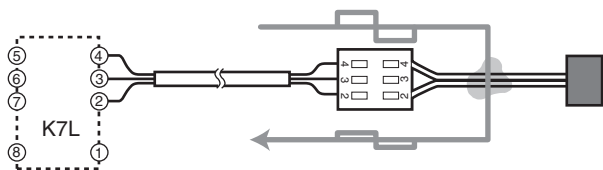

Disconnection detection function

(This applies only to Liquid Leakage Sensor Amplifiers with disconnection detection function.)

Operation While Monitoring for Disconnection

- Output of disconnection detection signals starts within 2 s of power being supplied to the K7L and is repeated at 7-s intervals.
- Disconnection signals are DC signals of 10 V max. that are output for approximately 200 ms. During this time, the K7L is in disconnection monitoring mode, i.e. it monitors for disconnections only and the liquid leakage detection signals are stopped.
- If there is no disconnection, the disconnection detection signals (10 VDC) that are output pass through the Terminator and return to the K7L. The K7L takes this as normal, i.e., there is no disconnection.

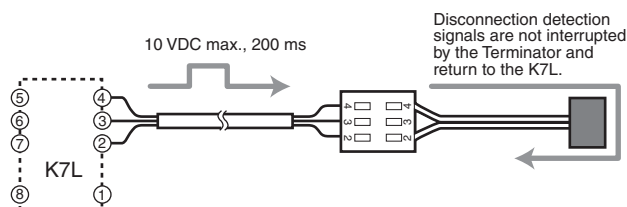



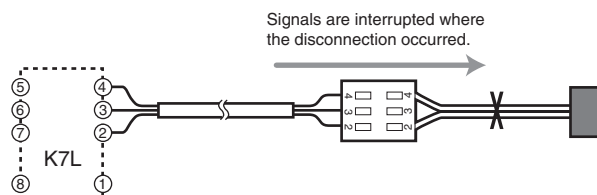

Operation at Disconnection Detection

- If there is a disconnection, the signals will be interrupted at the place where the disconnection occurred, and will not return to the K7L.
- If the signals do not return when the K7L is in disconnection monitoring mode, it will determine that a disconnection has occurred. The output indicator will flash, and the disconnection output will turn ON/OFF depending on the position of the DIP switch (right).



Classifications

Sensing Bands

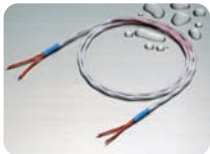
Model	Description	Appearance
F03-16PE	This is a basic sensing band. Use this Sensing Band for quick detection of liquid leaks in semiconductor production equipment, computer rooms, etc. This Sensing Band can also be used when the installation location has an electroconductive material.	
F03-16PT	The F03-16PT is made from fluoroplastic, which gives it higher resistance to both high temperatures and chemicals than the F03-16PE. This Sensing Band can detect on both sides.	
F03-15	Use this Sensing Band for dusty and humid environments. The electrodes are exposed, so install this Sensing Band in locations requiring insulated materials.	
F03-16PS F03-16PS-F	These are point-type sensors, so dismantling and wiping are easy. “-F” models have fluorine-coated electrodes, so they have superior resistance to chemicals. Also, multiple Sensing Bands can be connected to one Sensor Amplifier.	
F03-16SF	Greater flexibility compared with the F03-16PE. It is suitable for factory floors, ceilings, and winding around pipes.	
F03-16SFC	Greater flexibility compared with the F03-16PE. The sheath becomes transparent to reveal the red inner sheath if liquid leakage occurs, thereby enabling visual confirmation.	

For details on Sensing Bands, refer to the datasheets of individual products.

Further Information

Countermeasures Against Noise

Noise Canceller Function for Highly Sensitive Impedance Detection

The K7L Liquid Leakage Sensor Amplifier detects liquids with impedance as high as 50 MΩ and connects to the Sensing Band through a cable that can be extended up to 50 meters. Countermeasures against external noise are especially important for the Sensing Band and connecting cable because they pick up external noise like an antenna. The K7L incorporates the noise canceller function described below.

Connected with 3-conductor Cable that Offsets Inductive Noise (Patent Pending)

A VCT cable with three conductors (lines) is used. Line 1 is connected to the Sensing Band and line 2 is left open. Lines 1 and 2 are almost in the same position and thus will experience the same noise level.

The K7L obtains the difference between these signals. This means that the noise signals in lines 1 and 2 are offset against each other and a reading for the signal, without inductive noise, can be made.

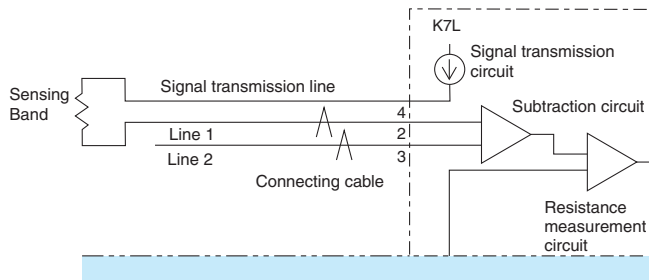

Detecting Liquid Leakage at Multiple Places

K7L-AT50

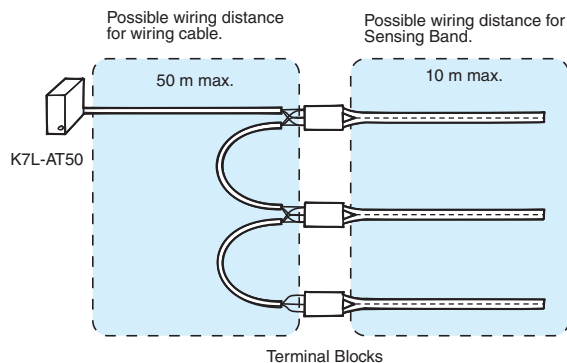

- Note:**
1. When wiring, be sure not to exceed the maximum possible wiring distances for both the connecting cable and the Sensing Band. Exceeding these distances may lead to faulty operation. Connect one Sensing Band to each Terminal Block.
 2. Not applicable to K7L-AT50D.

K7L-U

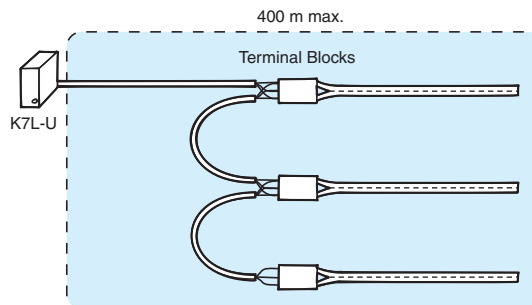

- Note:**
1. When wiring, be sure not to exceed the maximum possible wiring distances for both the connecting cable and the Sensing Band. Exceeding these distances may lead to faulty operation. Connect one Sensing Band to each Terminal Block.
 2. Not applicable to K7L-UD.

Wiring Distances for Sensing Band and Point Sensors

The wiring distance depends on the devices that are connected. Check the models of the Sensing Band, Point Sensors, and connected device and refer to the following table.

Connected Devices

- K7L-series Liquid Leakage Sensor Amplifiers
- 61F-GPN-V50/61F-WL series Water Leak Detectors

Table 1: Sensing Band Wiring Distances (Including Parallel Connections, Cable Cross-sectional Area: 2 mm²)

Type	Model	Combined Liquid Leakage Sensor Amplifier												
		Liquid Leakage Sensor Amplifiers for Long-distance Wiring	Liquid Leakage Sensor Amplifiers	Water Leak Detectors										
		K7L-U□ (no disconnection detection function) K7L-UD□ (with disconnection detection function)*1	K7L-AT50□ (no disconnection detection function) K7L-AT50D□ (with disconnection detection function)*1	61F-GPN-V50 61F-WL series										
Sensing Band	F03-15	Total of 400 m max. for wiring cables, Sensing Band, and Point Sensors	Total of 60 m max. for wiring cables, Sensing Band, and Point Sensors Sensing Band length: 10 m max.	The longer the wiring cables, the shorter the length of Sensing Band that can be connected. Table 2 <table border="1"> <thead> <tr> <th>Wiring Cables</th> <th>Sensing Band</th> </tr> </thead> <tbody> <tr> <td>0 m (Not used)</td> <td>200 m max.</td> </tr> <tr> <td>150 m max.</td> <td>150 m max.</td> </tr> <tr> <td>300 m max.</td> <td>100 m max.</td> </tr> <tr> <td>400 m max.</td> <td>50 m max.</td> </tr> </tbody> </table>	Wiring Cables	Sensing Band	0 m (Not used)	200 m max.	150 m max.	150 m max.	300 m max.	100 m max.	400 m max.	50 m max.
	Wiring Cables				Sensing Band									
	0 m (Not used)				200 m max.									
	150 m max.				150 m max.									
	300 m max.				100 m max.									
400 m max.	50 m max.													
F03-16PE														
F03-16PT														
F03-16SF														
F03-16SFC														
Point Sensor*2	F03-16PS													

*1. Point Sensors can not be used with models that have disconnection detection function. Also, Sensing Bands cannot be connected in parallel.
 *2. Point Sensors come with two 2-meter cables. Think of these cables as the wiring cables.

Example: Parallel Connection of 61F-GPN-V50/61F-WL series, Point Sensors and a Sensing Band

Find the wiring cable length and Sensing Band length from Table 2.
 The wiring cable length is the total for wiring cable A and wiring cable B (the cables attached to the Point Sensor) in the following figure.
 When five Point Sensors are used, the total for wiring cable B is 2 meters x 2 cables x 5 Sensors (20 m).
 The length of wiring cable A (100 meters) plus the length of wiring cable B (20 meters) gives a wiring cable length of 120 meters.

This corresponds to a wiring cable length of 150 max. in Table 2, so the maximum length of Sensing Band that can be connected is 150 meters.

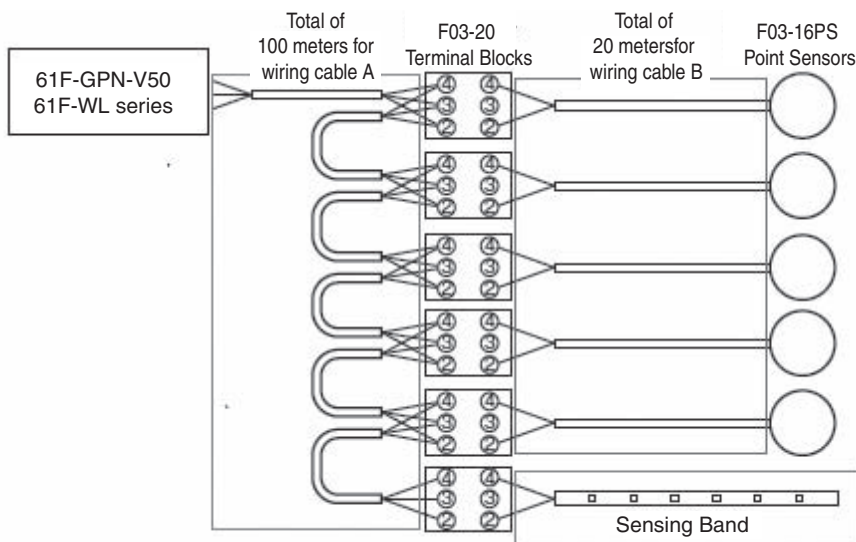

Use no more than 150 meters of Sensing Band.

Example: Parallel Connection of K7L-AT50 or K7L-U, Point Sensors, and a Sensing Band

Check the total lengths of wiring cable A and wiring cable B and the Sensing Band in the following figure.

- Wiring Cable B (Cables Attached to Point Sensors)

Point Sensors come with two 2-meter cables attached, so if two Point Sensors are used, the total for wiring cable B is 2 meters x 2 cables x 2 Sensors (8 m).

