

Freeing people from monotonous and heavy physical work

The challenges of meeting today's bulk part feeding needs

Production workers are hard to come by these days, and labor costs have risen sharply, putting pressure on manufacturers to automate complex manual processes. Automated systems must continue to identify complex shapes among bulk parts, pick them up, and align them according to feeding types and locations. While many automated part picking solutions fail to achieve human-level speed and flexibility, Omron is making great progress in this area.



Three features of 3D vision sensing close to human capabilities

Small and light

Fits in preexisting compact spaces

Approx. 0.4 s to detect *1

Faster cycle time thanks to human-like speed and flexibility

Wizards

Easy setup without manuals

*1. Total time for 3D measurement and 3D recognition under our specified conditions. It varies depending on the target.



Fits in preexisting compact spaces

The 3D vision sensor can be installed without a major change in the layout of the production system.

Small and light design saves installation space

BEFORE The production site layout must be significantly changed for automation

Others 3D vision sensor and its mounting equipment are too big to install in a typical workspace, requiring a major layout change.

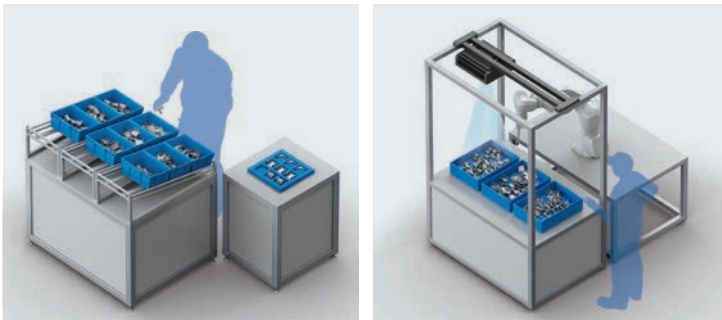

Space is limited to a human worker. Equipment to mount a camera is required.

3D vision sensor



Approx. 0.6 kg

AFTER The FH 3D Vision Sensor fits into without changing the layout

Small and light 3D vision sensor for robot arms can fit into a compact area within the work cell.



Flexible part picking from multiple locations

Combined with a robot, the sensor enables flexible picking according to the positions of part trays and shelves.

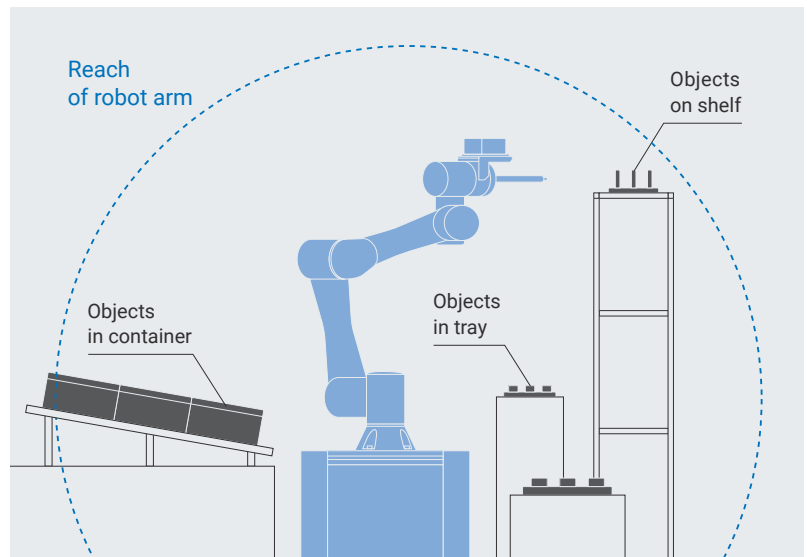

Easily transportable to where needed

The picking system, consisting of the 3D vision sensor for robot arms, collaborative robot, and mobile workstation, can be flexibly transported and relocated for different workspaces.

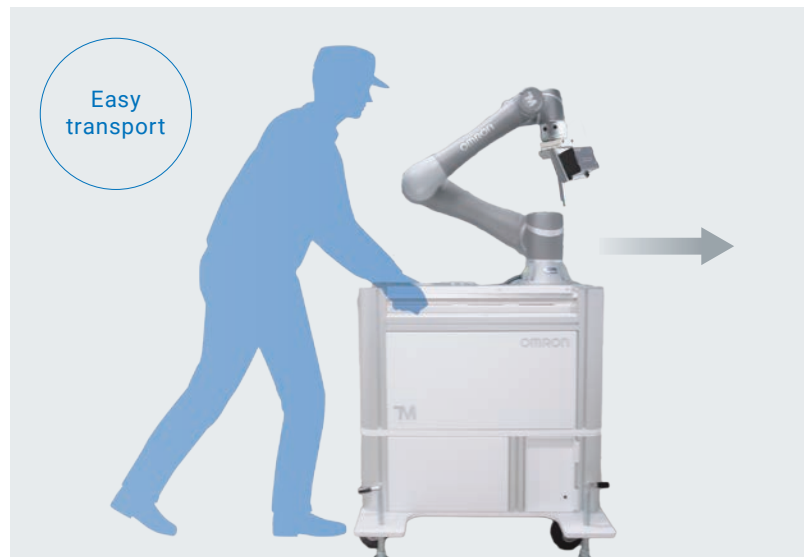

Optical technology makes the sensor small and light enough to mount on collaborative robots

Others 3D cameras using the phase-shifting method requires a projection mechanism that changes the projection pattern, resulting in a large size. Omron addressed this challenge and developed the 3D measurement technology that reduces in size by making the optical path compact with the mask creating fine patterns.

Target is recognized by illuminating it by one 3D projection pattern.

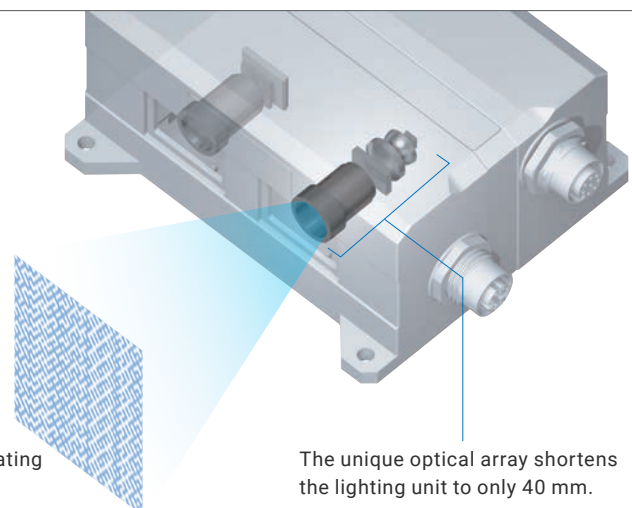

The unique optical array shortens the lighting unit to only 40 mm.

Faster cycle time thanks to human-like speed and flexibility

The advanced 3D vision sensing technology enables fast and accurate part recognition.

High-speed detection in approximately 0.4 seconds*1 makes picking smooth

3D measurement to create 3D shape images and 3D recognition to recognize the position and posture of targets were sped up, which made high-speed part detection possible.

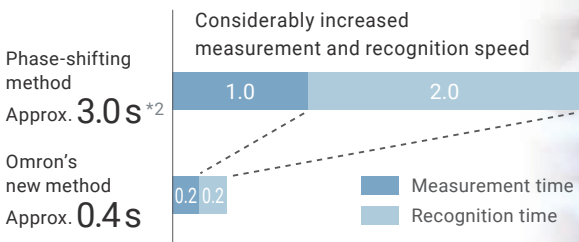
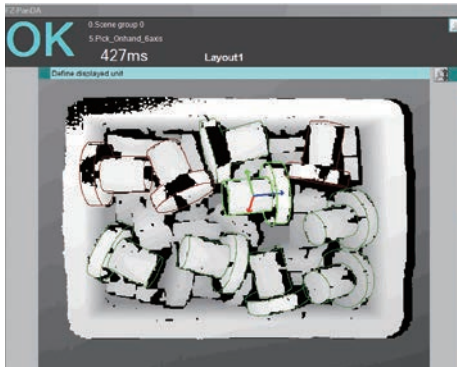

New technologies enable high-speed detection in approximately 0.4 seconds

3D measurement technology for a single-shot measurement **PATENTED***3

BEFORE

Phase-shifting method
Multiple shots

Many images need to be captured for measurement while the projection pattern is changed.



AFTER

Omron's structured light
One shot

A unique projected pattern image can be captured for measurement.

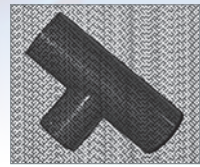

3D recognition technology for improved high-speed 2D search **PATENTED***3

BEFORE

Previous 3D recognition searches using large-volume model

Comprehensive matching using 3D model

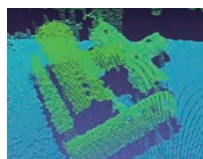

Search and comparison

AFTER

Omron's new method searches using small-volume model

3D matching after efficiently narrowing down the area using 2D feature model



Search

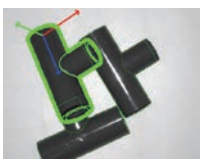

Comparison

*1. Total time for 3D measurement and 3D recognition under our specified conditions. It varies depending on the target.

*2. Time measured under our specified conditions is provided for reference.

*3. "PATENT PENDING" means that we applied for a patent in Japan, and "PATENTED" means that we obtained a patent in Japan. (As of January 2023)

Breaking the challenge of emptying all bins with less blind spots

There are blind spots where a fixed camera cannot detect parts inside the bin. To detect these parts, an operator must reposition items in the bin so that the parts are within the field of view. Cameras installed at the robot arms can reduce blind spots by changing the viewpoint, reliably detecting parts without using large-scale equipment.

BEFORE Fixed camera

There are blind spots where parts cannot be detected.

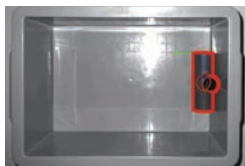
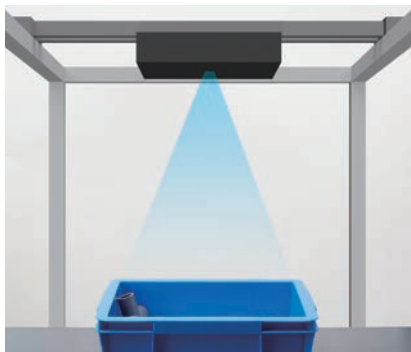

From above :
Cannot detect because the cylindrical part is too small to be detected

AFTER Camera for robot arms

The camera changes the viewpoint, reducing blind spots.

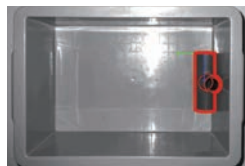
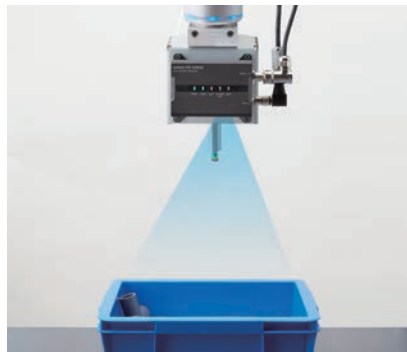

From above :
Cannot detect because the cylindrical part is too small to be detected

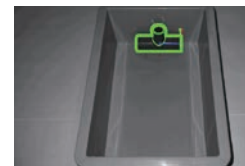

Moved to upper right :
Can detect

HDR reduces reflection from metal surfaces for reliable detection

3D measurement for bin picking sometimes encounters difficulties such as reflections or shadows caused by optical conditions varying depending on the object position and posture. HDR can simultaneously detect multiple objects within the field of view by combining images captured with different exposure times. This function is effective for highly glossy surfaces and mixed-material objects.

BEFORE Without HDR

Exposure is adjusted to objects at lower right of field of view.

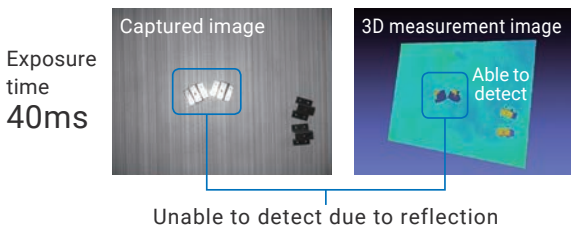

Exposure is adjusted to objects at center of field of view.

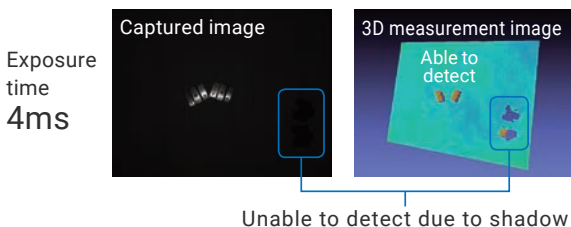

AFTER With HDR

HDR combines images captured with different exposure times for each area, lower right and center, to create 3D measurement images for simultaneous detection.

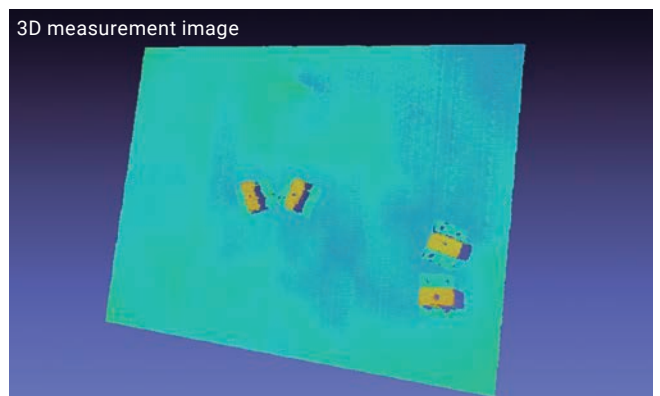

Note: When HDR is used, the detection time will be increased according to the number of images to be captured.

Easy setup without manuals

The wizards guide you step-by-step through setting up a picking application, from camera setup to calibration.

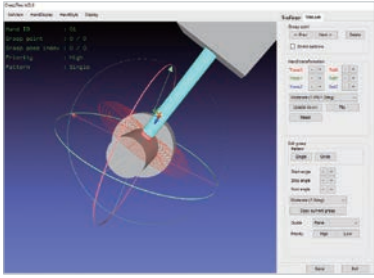
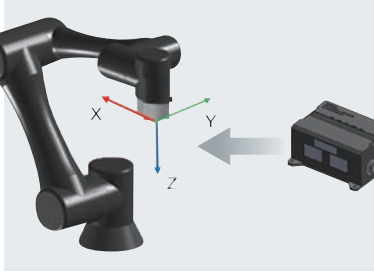
Setup procedure	You want to	Support function in wizard
Capture, recognition	Create a part model for 3D recognition seen from all directions	Just load CAD data Model Registration 
Grasping object	Register a pose of grasping and test without operating the robot	No need to operate the robot Grasp Pose Registration 
Coordination with robot	Set up to calibrate the camera and robot	No need to operate the robot Automatic Calibration 
	Set up to connect the robot	Sample programs for various robots Robot Setting Tool 

Wizards

Just follow the instructions in the wizards to set approximately 80 parameters required for a picking application, without referring to manuals.

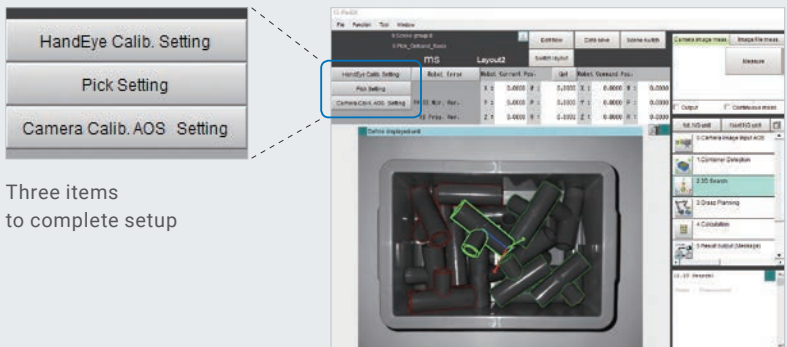

Three items to complete setup



Choose one from three items to suit your needs.

In case of Pick Setting

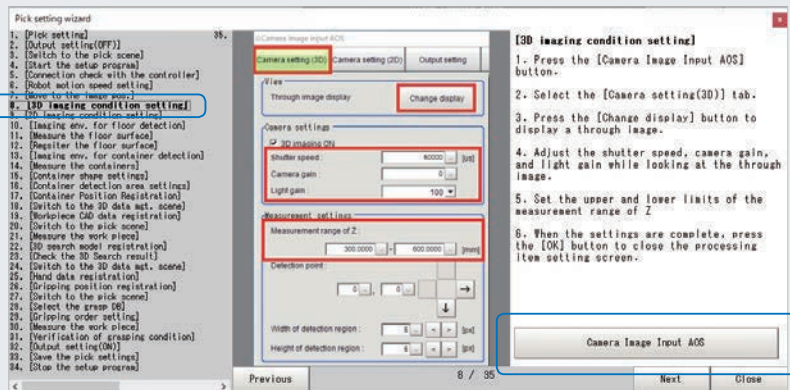

Understand the setup procedure and items to enter together with the image of the setup screen.

Click the button at the lower right to display a separate operation window.

Setup procedure and wizard

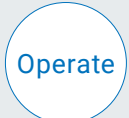
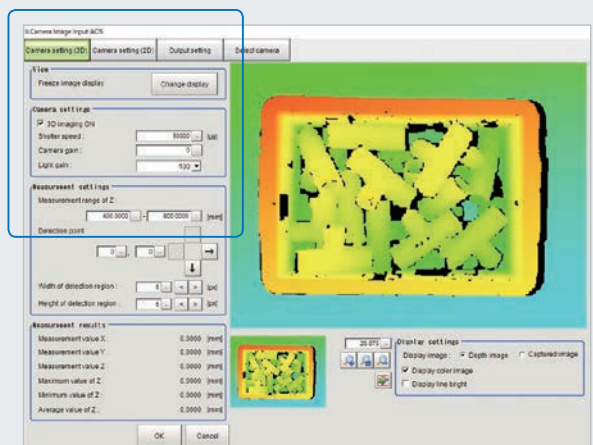

Enter the settings while referring to the setup procedure.

Operation window (displayed in a separate window)

Capture, recognition

Model Registration

Just load CAD data of a part to automatically generate a 3D search model.
 The CAD data of parts, grasp point data, and hand data can be managed to use for all scenes.
 When a new product is added, search models of its parts can be generated from the managed CAD data by copying the scene data.

Data manager screen

No	Name	Size
0	HandEyeCalibTarget	472920
1	022-PIPE_PVCTTD161...	110096
2	015-LINK	32448
3	W1_new(R4)	14120
4	W2_fixed	4920
5	W3_fixed	38920
6	W4_fixed	38120
7		
8		
9		
10		
11		

Integrated management of CAD data, hand data, and grasp data

Model registration screen

A single click to generate a 3D search model from CAD data

Grasping object

Grasp Pose Registration

Grasp poses can be set on part's CAD data, which eliminates the need to operate a physical robot.

Grasp poses can be set on 3D graphics

Multiple grasp points can be set

Automatic Calibration

Calibration between the 3D vision sensor and robot can be performed automatically without the need for complicated setup.

Enter values in only two fields

Click a button to automatically calibrate

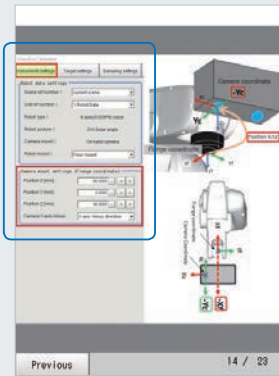

Specify the offset position of the 3D vision sensor

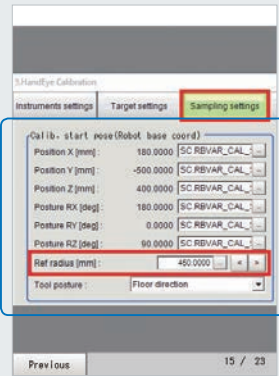

Specify the distance between the camera and calibration target

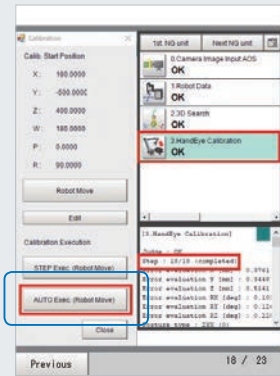

Execute automatic calibration

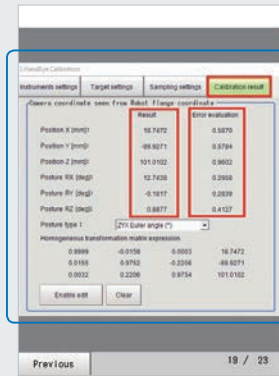

Result values are displayed

Robot Setting Tool

Omron provides sample scene data and robot connection programs tailored to individual robots. You can download the Robot Setting Tool for free after purchasing the product and signing up online. For details, see the member registration sheet attached to the 3D Robot Vision Software.

A sample scene data for the 3D vision sensor and sample program for the robot can be automatically created just by selecting the connected robot.

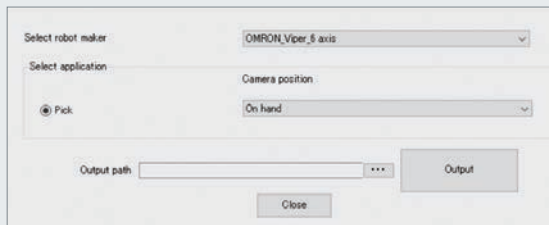

Robot Setting Tool

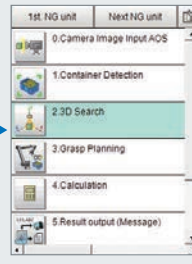

Sample scene data for 3D vision sensor

- For picking application
- For hand-eye calibration

Easy to connect



Sample program for robot

- Sample program
- Setup program

System configuration

Omron offers the 3D robot vision system and robots for picking applications.

3D Robot Vision System

This system recognizes positions and postures of parts and outputs the position information of parts to the robot.



**3D Vision Sensor
for Robot arms**
FH-SMD Series



Vision System
FH Series
FH-5050



3D Robot Vision Software

You can use it just by adding it to the sensor controller.

- 3D recognition
- Communications with robots
- Calibration

Robot

Robots from Omron and other major vendors can be used.

Collaborative Robots

TM Series



TM5X-700

TM5X-900

TM14X

TM12X

Reach	700 mm	900 mm	1100 mm	1300 mm
Max. payload	6 kg	4 kg	14 kg	12 kg



For more information about TM series, visit Omron's website:
<http://www.ia.omron.com/tm>

Industrial Articulated Robots

Viper Series



Viper 650

Viper 850

Reach	653 mm	855 mm
Max. payload	5 kg	5 kg



For more information about Viper series, visit Omron's website:
<http://www.ia.omron.com/viper>



Super-flexible cable ensures long-term stable operation

The new cable offers approximately 10 times*1 the bending resistance of conventional flexible cables. High bending resistance significantly reduces the frequency of replacing the cables on robot arms.

*1. It's compared with the FHV7 Smart Camera flexible cables.

Special material for insulation reduces friction between conductors

Highly bending-resistant special conductor

Special structure for braided shield and special soft material for outer jacket increase wear resistance

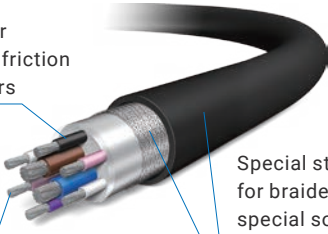

3D Robot Vision System FH-SMD Series

A complete solution for automating human-intensive part picking

- Compact and lightweight weighing approximately 0.6 kg
- High-speed detection in approximately 0.4 seconds *1
- 3 wizards for easy setup without manuals



System Configuration

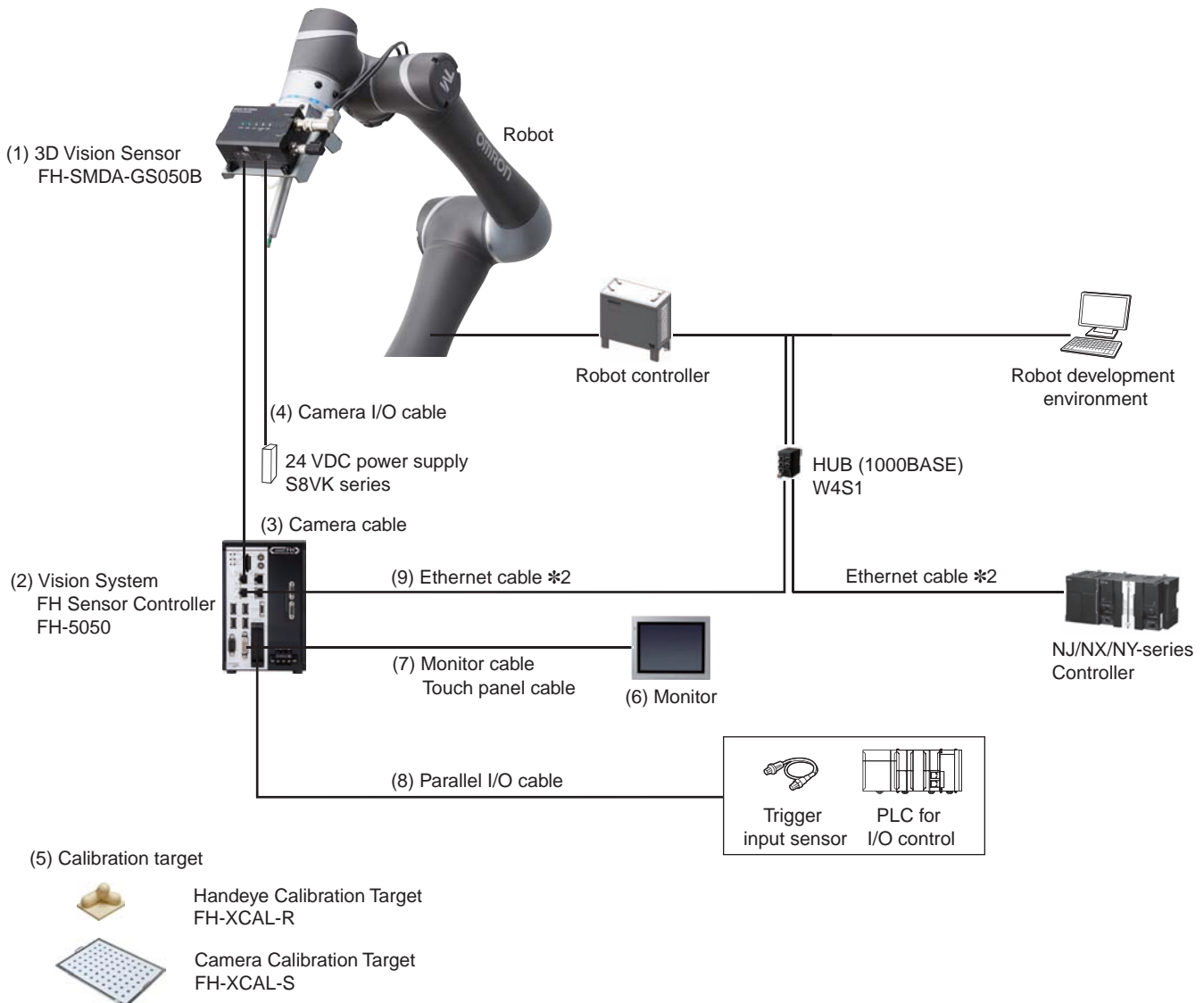

*1. Total time for 3D measurement and 3D recognition under our specified conditions. It varies depending on the target.
 *2. To use STP (shielded twisted-pair) cable of category 5 or higher for Ethernet and RJ45 connector.

Ordering Information

(1) 3D Vision Sensor

Item	Model
 <p>3D Vision Sensor</p>	FH-SMDA-GS050B

(2) Sensor Controller

Item	Model
 <p>Sensor Controller</p>	FH-5050



Note: FH-5050-10 and FH-5050-20 are not applicable.

Software Sold Separately



Item	Model
 <p>3D Robot Vision Software Installer *</p>	FH-UM3D1

* This product can be installed on the FH-5050 (version 6.40 or later).

(3) Camera Cables

Item	Descriptions	Cable length	Model
	Straight Ethernet Cable	5 m	FHV-VNBX2 5M
		10 m	FHV-VNBX2 10M
	Right-angle Ethernet Cable	5 m	FHV-VNLBX2 5M
		10 m	FHV-VNLBX2 10M

(4) Camera I/O Cables



Item	Descriptions	Cable length	Model
	Straight	5 m	FH-VSDX-BX 5M
		10 m	FH-VSDX-BX 10M
	Right-angle	5 m	FH-VSDX-LBX 5M
		10 m	FH-VSDX-LBX 10M

FH-SMD Series

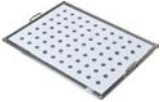
(5) Calibration Targets



Item	Model
 Handeye Calibration Target	FH-XCAL-R
 Camera Calibration Target	FH-XCAL-S

(6) Monitor

Item	Descriptions	Model
 Touch Panel Monitor 12.1 inches For FH Sensor Controllers *		FH-MT12
 LCD Monitor 8.4 inches		FZ-M08

* FH Series Sensor Controllers version 5.32 or higher is required.



(7) Monitor Cables

Item	Descriptions	Cable length	Model
	DVI-Analog Conversion Cable for Touch Panel Monitor/LCD Monitor	2 m	FH-VMDA 2M
		5 m	FH-VMDA 5M
		10 m	FH-VMDA 10M
	RS-232C Cable for Touch Panel Monitor	2 m	XW2Z-200PP-1
		5 m	XW2Z-500PP-1
		10 m	XW2Z-010PP-1
	USB Cable for Touch Panel Monitor	2 m	FH-VUAB 2M
		5 m	FH-VUAB 5M

A video signal cable and an operation signal cable are required to connect the Touch Panel Monitor.

Signal	Cable	2 m	5 m	10 m
Video signal	DVI-Analog Conversion Cable	Yes	Yes	Yes
Touch panel operation signal	USB Cable	Yes	Yes	No
	RS-232C Cable	Yes	Yes	Yes

(8) Parallel I/O Cables

Item	Descriptions	Model
	Parallel I/O Cable *1 Cable length: 2m, 5m or 15m	XW2Z-S013-□ *2
	Parallel I/O Cable for Connector-terminal Conversion Unit *1 Cable length: 0.5 m, 1 m, 1.5 m, 2 m, 3 m, 5 m Connector-Terminal Block Conversion Units can be connected (Terminal Blocks Recommended Products: OMRON XW2K-34G-T)	XW2Z-□□□EE *3
	Ultra-Compact Interface Wiring System (General-Purpose)	XW2K-34G-T *4

*1. 2 Cables are required for all I/O signals.

*2. Insert the cables length into □ in the model number as follows. 2 m = 2, 5 m = 5, 15 m = 15





*3. Insert the cables length into □□□ in the model number as follows. 0.5 m = 050, 1 m = 100, 1.5 m = 150, 2 m = 200, 3 m = 300, 5 m = 500

*4. Refer to the XW2K Series Datasheet (Cat. No. G152) for details.

(9) Recommended EtherCAT and EtherNet/IP Communications Cables

Use Straight STP (shielded twisted-pair) cable of category 5 or higher with double shielding (braiding and aluminum foil tape) for EtherCAT.
 Use Straight or cross STP (shielded twisted-pair) cable of category 5 or higher for EtherNet/IP.

Cable with Connectors

Item	Appearance	Recommended manufacturer	Cable length (m)	Model
Cable with Connectors on Both Ends (RJ45/RJ45) Standard RJ45 plugs type *1 Wire Gauge and Number of Pairs: AWG26, 4-pair Cable Cable Sheath material: PUR Cable color: Yellow *2		OMRON	0.3	XS6W-6PUR8SS30CM-YF
			0.5	XS6W-6PUR8SS50CM-YF
			1	XS6W-6PUR8SS100CM-YF
			2	XS6W-6PUR8SS200CM-YF
			3	XS6W-6PUR8SS300CM-YF
			5	XS6W-6PUR8SS500CM-YF
Cable with Connectors on Both Ends (RJ45/RJ45) Rugged RJ45 plugs type *1 Wire Gauge and Number of Pairs: AWG22, 2-pair Cable Cable color: Light blue		OMRON	0.3	XS5W-T421-AMD-K
			0.5	XS5W-T421-BMD-K
			1	XS5W-T421-CMD-K
			2	XS5W-T421-DMD-K
			5	XS5W-T421-GMD-K
			10	XS5W-T421-JMD-K
Cable with Connectors on Both Ends (M12 Straight/M12 Straight) Shield Strengthening Connector cable *3 M12/Smartclick Connectors Wire Gauge and Number of Pairs: AWG22, 2-pair Cable Cable color: Black		OMRON	0.5	XS5W-T421-BM2-SS
			1	XS5W-T421-CM2-SS
			2	XS5W-T421-DM2-SS
			3	XS5W-T421-EM2-SS
			5	XS5W-T421-GM2-SS
			10	XS5W-T421-JM2-SS
Cable with Connectors on Both Ends (M12 Straight/RJ45) Shield Strengthening Connector cable *3 M12/Smartclick Connectors Rugged RJ45 plugs type Wire Gauge and Number of Pairs: AWG22, 2-pair Cable Cable color: Black		OMRON	0.5	XS5W-T421-BMC-SS
			1	XS5W-T421-CMC-SS
			2	XS5W-T421-DMC-SS
			3	XS5W-T421-EMC-SS
			5	XS5W-T421-GMC-SS
			10	XS5W-T421-JMC-SS

*1. Cables with standard RJ45 plugs are available in the following lengths: 0.2 m, 0.3 m, 0.5 m, 1 m, 1.5 m, 2 m, 3 m, 5 m, 7.5 m, 10 m, 15 m, 20 m.
 Cables with rugged RJ45 plugs are available in the following lengths: 0.3 m, 0.5 m, 1 m, 2 m, 3 m, 5 m, 10 m, 15 m.

For details, refer to the Industrial Ethernet Connectors Catalog (Cat. No. G019).

*2. Cables colors are available in yellow, green, and blue.

*3. For details, contact your OMRON representative.

Cables / Connectors







Item	Recommended manufacturer	Model
Products for EtherCAT or EtherNet/IP (1000BASE-T/100BASE-TX) Wire gauge and number of pairs: AWG24, 4-pair cable	Cable	Hitachi Metals, Ltd. NETSTAR-C5E SAB 0.5 x 4P CP *1
	RJ45 Connector	Kuramo Electric Co. KETH-SB *1
		Panduit Corporation MPS588-C *1
Products for EtherCAT or EtherNet/IP (100BASE-TX/10BASE-T) Wire gauge and number of pairs: AWG22, 2-pair cable	Cable	Kuramo Electric Co. KETH-PSB-OMR *2
		JMACS Japan Co., Ltd. PNET/B *2
	RJ45 Assembly Connector	OMRON XS6G-T421-1 *2

*1. We recommend you to use the above Cable and RJ45 Connector together.

*2. We recommend you to use the above Cable and RJ45 Assembly Connector together.

FH-SMD Series

Accessories

Item	Descriptions			Model	
	USB Memory	2 GB		FZ-MEM2G	
		16 GB		FZ-MEM16G	
	SD Card	2 GB		HMC-SD293	
		4 GB		HMC-SD493	
		16 GB		HMC-SD1A3	
	Display/USB Switcher			FZ-DU	
---	Mouse Recommended Products Driverless wired mouse (A mouse that requires the mouse driver to be installed is not supported.)			---	
	EtherCAT junction slaves	3 port	Power supply voltage: 20.4 to 28.8 VDC (24 VDC -15 to 20%)	Current consumption: 0.08 A	GX-JC03
		6 port		Current consumption: 0.17 A	GX-JC06
	Industrial Switching Hubs for EtherNet/IP and Ethernet		5 port	Current consumption: 0.07 A	W4S1-05D

Ratings and Specifications

3D Vision Sensor

Model		FH-SMDA-GS050B
Image elements		CMOS image elements
Color/Monochrome		Monochrome
Effective pixels		1296 (H) x 972 (V)
Shutter function		Electronic shutter, Shutter speeds can be set from 1 ms to 50 ms.
Measurement range (X,Y,Z)		400 x 300 x 200 mm
Installation distance		WD: 400 mm
Lighting for 2D	Lighting color	blue
	LED class	Group 2 (IEC62471)
Lighting for 3D	Lighting color	blue
	LED class	Group 2 (IEC62471)
Indicator Lamps		PWR: Green LINK: Green ACT: Yellow WARM UP: Yellow ERR: Red
External I/F	FH controller connection	GigE (1000BASE-T) x 1 100Base cannot be used. PoE is not available.
	Power supply, Input / output	Power supply: 24 VDC I/O: -
Warming up time		15 minutes or less
Supply Voltage		21.6 VDC to 26.4 VDC (24 VDC \pm 10%)
Current consumption		2A max.
Vibration tolerance		Oscillation frequency: 10 to 150 Hz, Half amplitude: 0.35 mm, Sweep time: 8 minute/count, Sweep count: 10, Vibration direction: X/Y/Z
Shock resistance		Impact force: 150 m/s ² , Test direction: up and down/front and behind/left and right
Ambient temperature range		Operating: 0°C to +40°C Storage: -25 to +60°C (with no icing or condensation)
Ambient humidity range		Operating and storage: 35 to 85% (with no condensation)
Ambient atmosphere		No corrosive gases
Grounding		Class D grounding (100 Ω or less grounding resistance) *1
Dimensions		53 mm x 110 mm x 77 mm (Excluding protrusions and connectors)
Degree of protection		IEC60529 IP60
Material		Aluminium (A5052)
Weight		Approx. 570 g
Accessories		Instruction Sheet General Compliance Information and Instructions for EU

*1. Existing the third class grounding

Note: 1. This camera cannot be used as a measuring instrument, because it is not an absolute distance. Use in combination with robot calibration.

Sensor Controller for 3D Robot Vision

Model		FH-5050	
Controller Type		Box type	
Parallel IO polarity		NPN/PNP (common)	
Main Functions	Operation Mode	Standard	Yes
		Double Speed Multi-input	No
		Non-stop adjustment mode	No
		Multi-line random-trigger mode	No
	Parallel Processing		Yes
	Number of Connectable Camera		1 (Connect to the Ethernet port.)
	Supported Camera		FH-SMDA-GS050B
	Possible Number of Logging Images to Sensor Controller		Both 3D and 2D imaging: Up to 14 images 3D imaging only, 2D imaging only: Up to 29 images
	Possible Number of Scenes		Approximately 10 scenes (Varies depending on usage conditions.)
	Operating on UI	USB Mouse	Yes (wired USB and driver is unnecessary type)
Touch Panel		Yes (RS-232C/USB connection: FH-MT12)	
Setup		Create the processing flow using Flow editing.	
Language		Japanese, English	
External Interface	Serial Communication		RS-232C x 1
	Ethernet Communication	Protocol	Non-procedure (TCP/UDP)
		I/F	1000BASE-T x 2
	EtherNet/IP Communication		Yes (Target/Ethernet port)
	PROFINET Communication		<ul style="list-style-type: none"> • Yes (Slave/Ethernet port) • Conformance class A
	EtherCAT Communication		Yes (slave)
	Parallel I/O		9 inputs/22 outputs
	Encoder Interface		Not supported.
	Monitor Interface		DVI-I output (Analog RGB & DVI-D single link) x 1
	USB I/F		USB2.0 host x 2 (BUS Power: 5 V/0.5 A per port) USB3.0 host x 2 (BUS Power: 5 V/0.9 A per port)
SD Card I/F		SDHC x 1	
Indicator Lamps	Main		POWER: Green ERROR: Red RUN: Green ACCESS: Yellow
	Ethernet		NET RUN1: Green LINK/ACT1: Yellow NET RUN2: Green LINK/ACT2: Yellow
	SD Card		SD POWER: Green SD BUSY: Yellow
	EtherCAT		ECAT RUN: Green LINK/ACT IN: Green LINK/ACT OUT: Green ECAT ERR: Red
Supply Voltage		20.4 VDC to 26.4 VDC	
Current consumption		4.2 A max.	
Built-in FAN		Yes	

Model		FH-5050
Usage Environment	Ambient temperature range	Operating: 0°C to +45°C Storage: -20 to +65°C (with no icing or condensation)
	Ambient humidity range	Operating and storage: 35 to 85% (with no condensation)
	Ambient atmosphere	No corrosive gases
	Vibration tolerance	Oscillation frequency: 10 to 150 Hz, Half amplitude: 0.1 mm, Acceleration: 15 m/s ² Sweep time: 8 minute/count, Sweep count: 10, Vibration direction: up and down/front and behind/left and right
	Shock resistance	Impact force: 150 m/s ² Test direction: up and down/front and behind/left and right
	Noise immunity	<ul style="list-style-type: none"> • DC power: Direct infusion: 2 kV, Pulse rising: 5 ns, Pulse width: 50 ns, Burst continuation time: 15 ms/0.75 ms, Period: 300 ms, Application time: 1 min. • I/O line: Direct infusion: 1 kV, Pulse rising: 5 ns, Pulse width: 50 ns, Burst continuation time: 15 ms/0.75 ms, Period: 300 ms, Application time: 1 min.
	Fast Transient Burst	
Grounding	Class D grounding (100 Ω or less grounding resistance) *1	
External Features	Dimensions	190 mm x 115 mm x 182.5 mm Note: Height: Including the rubber at the base.
	Weight	Approx. 3.4 kg
	Degree of protection	IEC60529 IP20
	Case material	Cover: zinc-plated steel plate, Side plate: aluminum (A6063)
Accessories		Instruction Sheet (Japanese and English): 1, Installation Instruction Manual for FH series: 1, General Compliance Information and Instructions for EU: 1, Member registration sheet: 1, Power source (FH-XCN): 1 (male), Ferrite core for camera cable: 2

*1. Existing the third class grounding

FH-SMD Series

Camera Cable (Ethernet Cable)

Item	Model	FHV-VNBX2 5M	FHV-VNLBX2 5M	FHV-VNBX2 10M	FHV-VNLBX2 10M
Cable length		5 m		10 m	
Connector type		Straight connector	Right angle connector	Straight connector	Right angle connector
Cable type		Bending resistance cable			
Outer diameter		6.6 + 0.7 mm dia.			
Min. bending radius		40 mm			
Usage environment	Ambient temperature range	Operating: -10 to +70°C, Storage: -25 to +85°C (with no icing or condensation)			
	Ambient humidity range	Operating & Storage: 0 to 93% (With no condensation)			
	Ambient atmosphere	No corrosive gases			
	Vibration tolerance	Oscillation frequency: 10 to 150Hz, Half amplitude: 0.35 mm, Vibration direction: X/Y/Z, Sweep time: 8 minutes/count, Sweep count: 10 times			
	Shock resistance	Impact force: 150 m/s ² , Test direction: 6 directions, three time each (up/down, front/behind, left/right)			
Material		Mold part: PVC, Sheath part: PVC			
Weight		Approx. 390 g		Approx. 730 g	

Camera I/O Cables

Item	Model	FH-VSDX-BX 5M	FH-VSDX-LBX 5M	FH-VSDX-BX 10M	FH-VSDX-LBX 10M
Cable length		5 m		10 m	
Connector type		Straight connector	Right angle connector	Straight connector	Right angle connector
Cable type		Bending resistance cable			
Size		AWG26			
Outer diameter		5.8 mm dia.			
Min. bending radius		35 mm			
Usage environment	Ambient temperature range	Operating: 0 to +80°C, Storage: -20 to +80°C (with no icing or condensation)			
	Ambient humidity range	Operating & Storage: 0 to 93% (With no condensation)			
	Ambient atmosphere	No corrosive gases			
	Vibration tolerance	Oscillation frequency: 10 to 150Hz, Half amplitude: 0.35 mm, Vibration direction: X/Y/Z, Sweep time: 8 minutes/count, Sweep count: 10 times			
	Shock resistance	Impact force: 150 m/s ² , Test direction: 6 directions, three time each (up/down, front/behind, left/right)			
Material		Shell: Zinc alloy, brass, Sheath part: oil-resistant and heat-resistant polyvinyl chloride			
Weight		Approx. 320 g	Approx. 330 g	Approx. 570 g	Approx. 580 g

Calibration Targets

Model	FH-XCAL-R	FH-XCAL-S
Name	HandEye calibration target	Camera calibration target
Ambient temperature range	-25 to +65°C (with no icing or condensation)	
Ambient humidity range	35 to 85% (with no condensation)	
Ambient atmosphere	No corrosive gases	
Vibration tolerance	Oscillation frequency: 10 to 150 Hz, Half amplitude: 0.35 mm, Sweep time: 8 minute/count, Sweep count: 10, Vibration direction: X/Y/Z	
Shock resistance	Impact force: 150 m/s ² , Test direction: up and down/front and behind/left and right	
Dimensions	65 mm × 55 mm × 42.4 mm	350 mm × 470 mm × 25 mm
Material	ABS	Aluminium
Weight	Approx. 50 g	Approx. 1,400 g
Accessories	---	---

Touch Panel Monitor

Model		FH-MT12
Major Function	Display area	12.1 inch
	Resolution	1024 (V) × 768 (H)
	Number of color	16,200,000 colors (8 bit/color)
	Brightness	500cd/m ² (Typ)
	Contrast Ratio	700:1 (Typ)
	Viewing angle	Horizontal (left and right): -80° to 80° (Typ) Vertical (top and bottom): -70° to 70° (Typ)
	Backlight Unit	LED, edge-light
	Backlight lifetime	About 80,000 hour
	Touch panel	4 wire resistive touch screen
External interface	Video input	analog RGB
	Touch panel signal	USB RS-232C
Ratings	Power supply voltage	24 VDC (21.6 to 26.4 VDC)
	Current consumption	0.5 A
	Insulation resistance	Between DC power supply and Touch Panel Monitor FG: 20 MΩ or higher (rated voltage 250 V)
Operating environment	Ambient temperature range	Operating: 0 to 50°C, Storage: -20 to +65°C (with no icing or condensation)
	Ambient humidity range	Operating and Storage: 20 to 90%RH (with no icing or condensation)
	Ambient environment	No corrosive gas
	Vibration resistance	10 to 150 Hz, one-side amplitude 0.1 mm (Max. acceleration 15 m/s ²) 10 times for 8 minutes for each three direction
	Degree of protection	Panel mounting: IP65 on the front
Operation		Touch pen
Structure	Mounting	Panel mounting, VESA mounting
	Weight	Approx. 2.4 kg
	Material	Front panel: PC/PBT, Front Sheet: PET, Rear case: SUS

Note: FH Series Sensor Controllers version 5.32 or higher is required.

Monitor Cables

Model	FH-VMDA (2 m)	FH-VUAB (2 m)	XW2Z-200PP-1 (2 m)
Cable type	DVI-Analog Conversion Cable	USB Cable	RS-232C Cable
Vibration resistance	10 to 150 Hz, one-side amplitude 0.1 mm, 10 times for 8 minutes for each three direction		
Ambient Temperature	Operating Condition: 0 to 50°C, Storage Condition: -10 to 60°C (with no icing or condensation)		
Ambient Humidity	Operating Condition: 35 to 85%RH, Storage Condition: 35 to 85%RH (with no icing or condensation)		
Ambient environment	No corrosive gases		
Material	Cable outer sheath, Connector: PVC		Cable outer sheath: PVC, Connector: ABS/Ni Plating
Minimum bend radius	62 mm	25 mm	59 mm
Weight	Approx. 210 g	Approx. 95 g	Approx. 162 g

LCD Monitor

Model	FZ-M08
Size	8.4 inches
Type	Liquid crystal color TFT
Resolution	1,024 × 768 dots
Input signal	Analog RGB video input, 1 channel
Power supply voltage	21.6 to 26.4 VDC
Current consumption	Approx. 0.7 A max.
Ambient temperature range	Operating: 0 to 50 °C; Storage: -25 to 65 °C (with no icing or condensation)
Ambient humidity range	Operating and storage: 35 to 85% (with no condensation)
Weight	Approx. 1.2 kg
Accessories	Instruction Sheet and 4 mounting brackets

FH-SMD Series

EtherCAT Communications Specifications

Item	Specifications	
Communications standard	IEC61158 Type 12	
Physical layer	100 BASE-TX (IEEE802.3)	
Modulation	Base band	
Baud rate	100 Mbps	
Topology	Depends on the specifications of the EtherCAT master.	
Transmission Media	Twisted-pair cable of category 5 or higher (double-shielded straight cable with aluminum tape and braiding)	
Transmission Distance	Distance between nodes: 100 m or less	
Node address setting	00 to 99	
External connection terminals	RJ45 × 2 (shielded) IN: EtherCAT input data, OUT: EtherCAT output data	
Send/receive PDO data sizes	Input	56 to 280 bytes/line (including input data, status, and unused areas) Up to 8 lines can be set. *
	Output	28 bytes/line (including output data and unused areas) Up to 8 lines can be set. *
Mailbox data size	Input	512 bytes
	Output	512 bytes
Mailbox	Emergency messages, SDO requests, and SDO information	
Refreshing methods	I/O-synchronized refreshing (DC)	

* This depends on the upper limit of the master.

Components and Functions

3D Vision Sensor

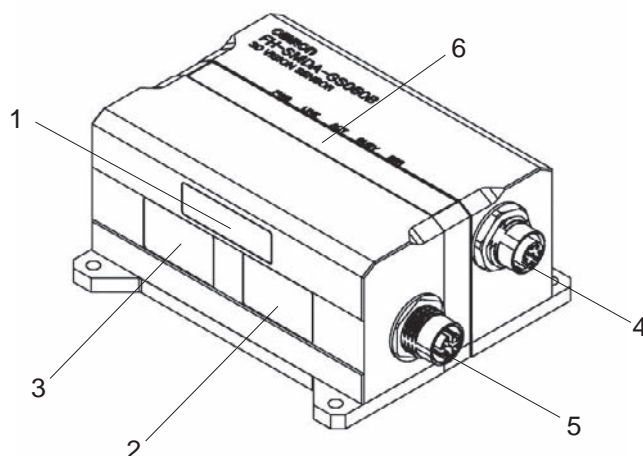

	Name		Description
1	2D lighting unit		Lighting for 2D measurement is arranged to illuminate the light.
2	3D lighting unit		Pattern lighting for 3D measurement is arranged to illuminate the light.
3	Imaging unit		Captures images.
4	Connector for camera I/O cable		Use this connector when connecting the camera with a power supply using a camera I/O cable. Dedicated camera I/O cable: FH-VSDX-BX / FH-VSDX-LBX)
5	Connector for camera cable (Ethernet cable)		Use this connector when connecting the camera with a FH sensor controller using an camera cable (Ethernet cable). Dedicated camera cable (Ethernet cable): FHV-VNBX2 / FHV-VNLBX2)
6	Operation indicator	PWR (Green)	Lights while power is supplied.
		LINK (Green)	Lights when connected with Ethernet equipment.
		ACT (Yellow)	Blinks while communicating with an Ethernet device.
		WARM UP (Yellow)	Lights from startup to completion of warming up. Turns off after warming up.
		ERR (Red)	Lights when an error occurs. For the error (system error), refer to the <i>Camera Image Input AOS in the Vision System FH series Processing Item Function Reference Manual for 3D Robot Vision</i> (Cat. No. Z445).

Sensor Controller

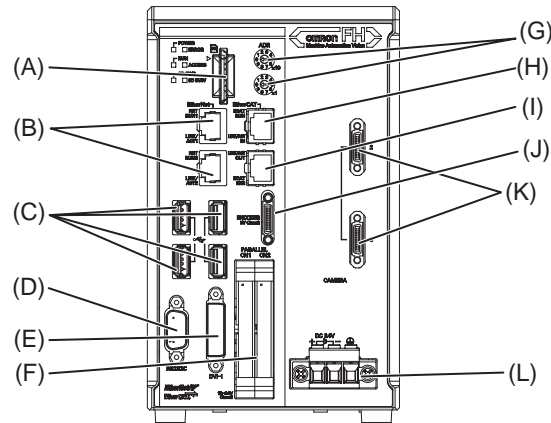

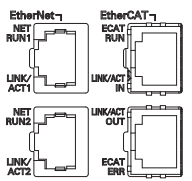
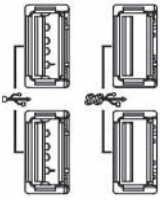
	Connector name	Description
(A)	SD memory card installation connector	Install the SD memory card. Do not plug or unplug the SD memory card during measurement operation. Otherwise measurement time may be affected or data may be destroyed.
(B)	Ethernet connector	<p>Connect an Ethernet device.</p> <div data-bbox="603 869 1369 1070" style="border: 1px solid black; padding: 5px;"> <p>Upper port : Ethernet port</p> <p>Lower port : Ethernet port, EtherNet/IP port, and PROFINET port are sharing use.</p>  </div> <p>Connect the camera cable (Ethernet cable FHV-VN□BX: sold separately) to the upper port.</p>
(C)	USB connector	<p>Connect a USB device. Do not plug or unplug it during measurement. Otherwise measurement time may be affected or data may be destroyed.</p> <div data-bbox="603 1205 1369 1545" style="border: 1px solid black; padding: 5px;"> <p>Left ports: USB2.0 Right ports: USB3.0</p> <p>The USB3.0 interface has a higher bus power supply capability than the USB2.0 interface, and you can expect more stable operation with it.</p> <p>Also, when used in combination with a USB3.0 device, you can expect higher transfer speed than USB2.0. Be sure to give priority to using the USB3.0 interface.</p>  </div>
(D)	RS-232C connector	Connect an external device such as a touch panel monitor.
(E)	DVI-I connector	Connect a monitor.
(F)	I/O (Parallel) connector (control lines, data lines)	Connect the controller to external devices such as a sync sensor and PLC.
(G)	EtherCAT address setup volume	Used to set a station address (00 to 99) as an EtherCAT communication device.
(H)	EtherCAT communication connector (IN)	Connect the opposed EtherCAT device.
(I)	EtherCAT communication connector (OUT)	Connect the opposed EtherCAT device.
(J)	Encoder connector	Not supported.
(K)	Camera connector	Not supported. Do not connect cameras.
(L)	Power supply terminal connector	Connect a DC power supply. Wire the FH Sensor Controller independently on other devices. Wire the ground line. Be sure to ground the FH Sensor Controller alone. Use an attachment power terminal (male) for installation.

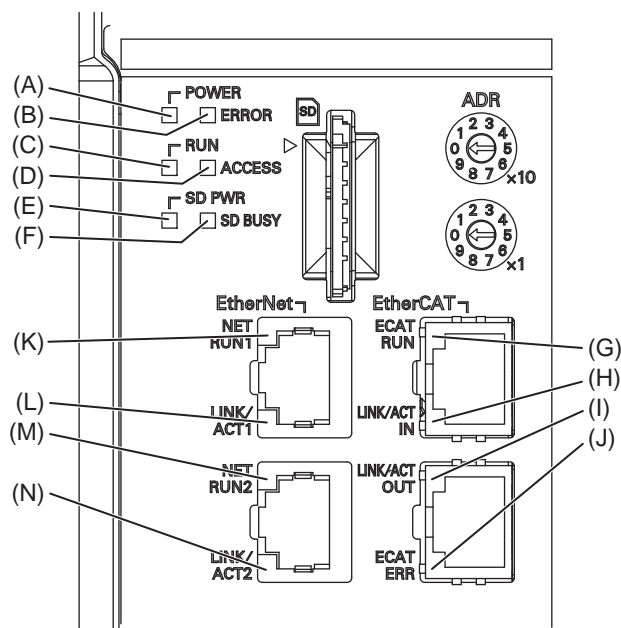













	LED name	Description
(A)	POWER LED	Lit while power is ON.
(B)	ERROR LED	Lit when an error has occurred.
(C)	RUN LED	Lit while the layout turned on output setting is displayed.
(D)	ACCESS LED	Blinks while the internal nonvolatile memory is accessed.
(E)	SD POWER LED	Lit while power is supplied to the SD memory card and the card is usable.
(F)	SD BUSY LED	Blinks while the SD memory card is accessed.
(G)	EtherCAT RUN LED	Lit while EtherCAT communications are usable.
(H)	EtherCAT LINK/ACT IN LED	Lit when connected with an EtherCAT device, and blinks while performing communications.
(I)	EtherCAT LINK/ACT OUT LED	Lit when connected with an EtherCAT device, and blinks while performing communications.
(J)	EtherCAT ERR LED	Lit when EtherCAT communications have become abnormal.
(K)	Ethernet NET RUN1 LED	Lit while Ethernet communications are usable.
(L)	Ethernet LINK/ACT1 LED	Lit when connected with an Ethernet device, and blinks while performing communications.
(M)	Ethernet NET RUN2 LED	Lit while Ethernet communications are usable.
(N)	Ethernet LINK/ACT2 LED	Lit when connected with an Ethernet device, and blinks while performing communications.

FH-SMD Series

Processing Items

Group	Icon	Processing Item	
Measurement		3D Search	Using CAD data of the workpiece, this processing item registers information on surfaces and contours that are seen from various viewpoints as a model, and then detects the position/posture of a workpiece that is most similar to the model based on the input depth map and input image. (For 3D robot vision)
		Container Detection	Defines a 3D container model for detecting collision of the hand model. (For 3D robot vision)
		Grasp Planning	Performs operations to enable the robot connected to the FH-series Sensor Controller to grasp the detected object. (For 3D robot vision)
		Search	Used to identify the shapes and calculate the position of measurement objects.
		Search II	Even if the Search processing item cannot detect a model, the Search II can stably detect it by creating the optimal model according to the size and rotation of the measurement object.
		Flexible Search	Recognizing the shapes of workpieces with variation and detecting their positions.
		Sensitive Search	Search a small difference by dividing the search model in detail, and calculating the correlation.
		Shape Search III	Robust detection of positions is possible at high-speed and with high precision incorporating environmental fluctuations, such as differences in individual shapes of the workpieces, pose fluctuations, noise superimposition and shielding.
		Classification	Used when various kinds of products on the assembly line need to be sorted and identified.
		Edge Position	Measure position of measurement objects according to the color change in measurement area.
		Edge Pitch	Detect edges by color change in measurement area. Used for calculating number of pins of IC and connectors.
		Scan Edge Position	Measure peak/bottom edge position of workpieces according to the color change in separated measurement area.
		Scan Edge Width	Measure max/min/average width of workpieces according to the color change in separated measurement area.
		Circular Scan Edge Position	Measure center axis, diameter and radius of circular workpieces.
		Circular Scan Edge Width	Measure center axis, width and thickness of ring workpieces.
		Intersection	Calculate approximate lines from the edge information on two sides of a square workpiece to measure the angle formed at the intersection of the two lines.
		Color Data	Used for detecting presence and mixed varieties of products by using color average and deviation.
		Gravity and Area	Used to measure area, center of gravity of workpieces by extracting the color to be measured.
		Labeling	Used to measure number, area and gravity of workpieces by extracting registered color.
		Precise Defect	Check the defect on the object. Parameters for extraction defect can be set precisely.
		Fine Matching	Difference can be detected by overlapping and comparing (matching) registered fine images with input images.
		Character Inspect	Recognize character according correlation search with model image registered in [Model Dictionary].
		Date Verification	Reading character string is verified with internal date.
		Model Dictionary	Register character pattern as dictionary. The pattern is used in [Character Inspection].
		2DCode II #1	Recognize 2D code and display where the code quality is poor.
		2DCode #2	Recognize 2D code and display where the code quality is poor.
		Barcode #3	Recognize barcode, verify and output decoded characters.
		OCR	Recognize and read characters in images as character information.
		OCR User Dictionary	Register dictionary data to use for OCR.
		Glue Bead Inspection	You can inspect coating of a specified color for gaps or runoffs along the coating path.

Group	Icon	Processing Item		
Input Image		Camera Image Input AOS #4	Loads images from the camera. (For 3D robot vision)	
		Measurement Image Switching	To switch the images used for measurement. Not input images from camera again.	
Compensate image		Position Compensation	Used when positions are differed. Correct measurement is performed by correcting position of input images.	
		Filtering	Used for processing images input from cameras in order to make them easier to be measured.	
		Background Suppression	To enhance contrast of images by extracting color in specified brightness.	
		Brightness Correct Filter	Track brightness change of entire screen and remove gradual brightness change such as uneven brightness.	
		Color Gray Filter	Color image is converted into monochrome images to emphasize specific color.	
		Extract Color Filter	Convert color image to color extracted image or binary image.	
		Anti Color Shading	To remove the irregular color/pattern by uniformizing max.2 specified colors.	
		Stripes Removal Filter II	Remove the background pattern of vertical, horizontal and diagonal stripes.	
		Polar Transformation	Rectify the image by polar transformation. Useful for OCR or pattern inspection printed on circle.	
		Trapezoidal Correction	Rectify the trapezoidal deformed image.	
		Image Subtraction	The registered model image and measurement image are compared and only the different pixels are extracted and converted to an image.	
		Advanced filter	Process the images acquired from cameras in order to make them easier to measure. This processing item consolidates existing image conversion filtering into one processing item and adds extra functions.	
	Support measurement		3D Data Manager	Manages the CAD data, hand data, and grasp pose data (grasp DB data) required for picking applications. (For 3D robot vision)
			Camera Calibration AOS #4	Calibrates the camera (3D vision sensor) using a dedicated calibration plate. (For 3D robot vision)
			HandEye Calibration	Calibrates the robot hand and camera (eye) to maintain the relationship of installation. (For 3D robot vision)
			Unit Macro	Advanced arithmetic processing can be easily incorporated into workflow as Unit Macro processing items.
			Unit Calculation Macro	This function is convenient when the user wants to calculate a value using an original calculation formula or change the set value or system data of a processing item.
		Calculation	Used when using the judge results and measured values of Proclern which are registered in processing units.	
		Line Regression	Used for calculating regression line from plural measurement coordinate.	
		Circle Regression	Used for calculating regression circle from plural measurement coordinate.	
		Trend Monitor	Used for displaying the information about results on the monitor, facilitating to avoid NG and analyze causes.	
		Image Logging	Used for saving the measurement images to the memory and USB memory.	
		Image Conversion Logging	Used for saving the measurement images in JPEG and BMP format.	
		Elapsed Time	Used for calculating the elapsed time since the measurement trigger input.	
		Wait	Processing is stopped only at the set time. The standby time is set by the unit of [ms].	
		Focus	Focus setting is supported.	
		Iris	Focus and aperture setting is supported.	
		Statistics	Used when you need to calculate an average of multiple measurement results.	
		Robot Data	Sets and stores data related to robots.	
		Data Save	The set data can be saved in the controller main unit or as scene data. The data is held even after the FH/FZ power is turned off.	
		Scene	The specified scene is copied to the current scene.	
		System Information	Obtain system information (e.g., memory and disk space and I/O input signal status) of the Sensor Controller.	

Group	Icon	Processing Item	
Branch		End	This Processing Item must be set up as the last processing unit of a branch.
		Conditional Execution (If)	The measurement flow is divided according to the comparison result obtained using the set expressions and conditions.
		Conditional Execution (Else)	Insert between the Conditional Execution (If) processing item and End If processing item. The measurement flow is divided according to the comparison result obtained using the set expressions and conditions.
		Loop	The set processes are repeated until the loop count reaches the specified number, and then the next process starts.
		Loop Suspension	Insert between the Loop processing item and End Loop processing item. Used to stop the loop before the loop count reaches the specified number.
		Select Execution (Select)	Used to set conditions. The measurement flow is divided according to the comparison result obtained using the conditions given by expressions.
		Select Execution (Case)	Used to make a judgment. The measurement flow is divided according to the comparison result obtained using the conditions given by expressions.
Output result		Result Output (I/O)	Output data to the external devices such as a programmable controller or a PC via PLC Link, Parallel interface, Fieldbus interface (EtherCAT, EtherNet/IP (other than message communication), PROFINET).
		Result Output (Message)	Output data to the external devices such as a programmable controller or a PC with non-procedure mode via the serial interface or EtherNet/IP (message communication). This processing item allows you to save the logging data as a ".csv" file into the Sensor Controller as well.
		Result Output (Parallel I/O)	Output measurement results and/or judgment results to the external devices such as a programmable controller or a PC via Parallel interface.
Display result		Result Display	Used for displaying the texts or the figures in the camera image.
		Display Last NG Image	Display the last NG images.
		Display Image Hold	Processing item to retain images, including measurement results.

*1. 2D Codes that can be read: Data Matrix (ECC200)

*2. 2D Codes that can be read: Data Matrix (ECC200), QR Code

*3. Bar Codes that can be read: JAN/EAN/UPC (including add-on codes), Code 39, Codabar (NW-7), ITF (Interleaved 2 of 5), Code 93, Code 128, GS1-128, GS1 DataBar (RSS-14 / RSS Limited / RSS Expanded), Pharmacode

*4. AOS: Active One Shot

FH-SMD Series

Dimensions

(Unit: mm)

3D Vision Sensor

FH-SMDA-GS050B

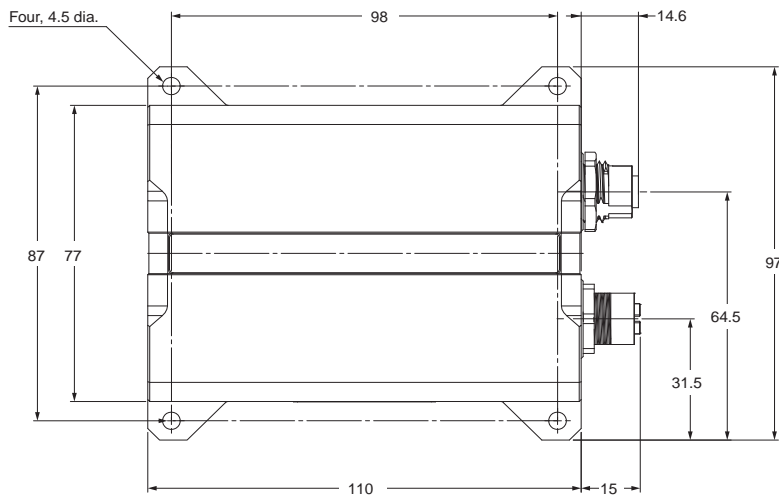

Mounting screw holes

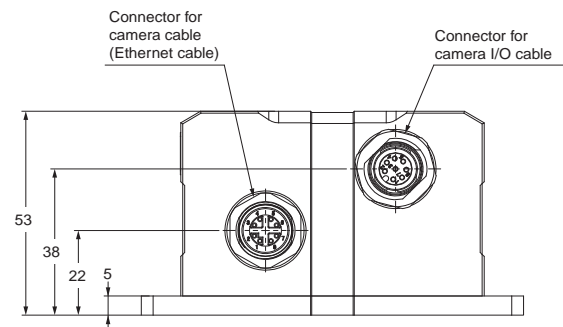
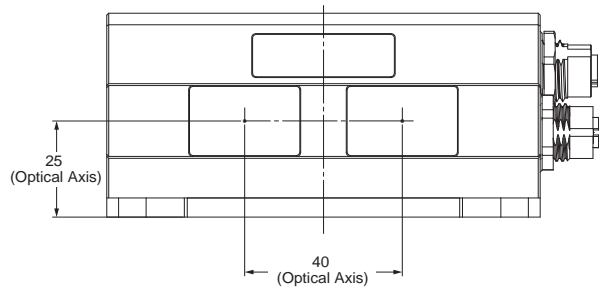
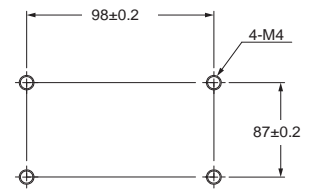

Sensor Controller

FH-5050

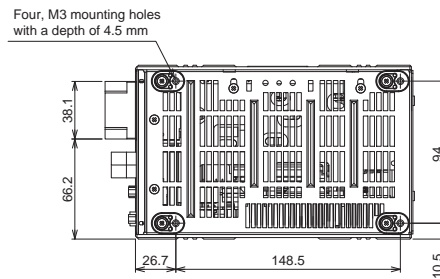
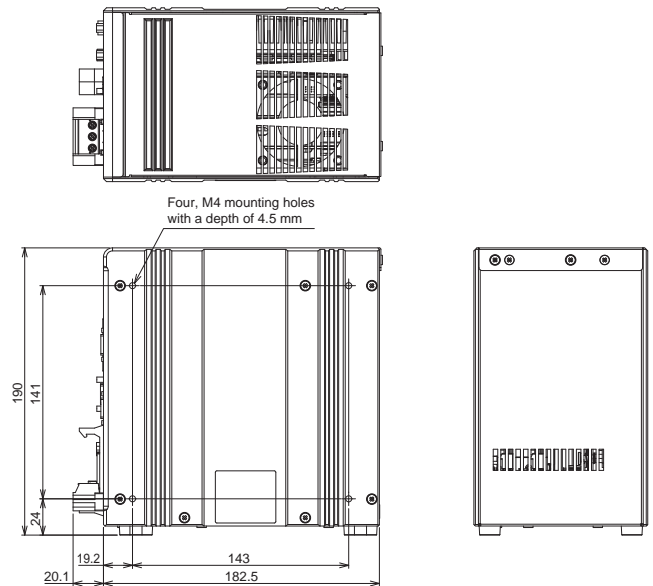
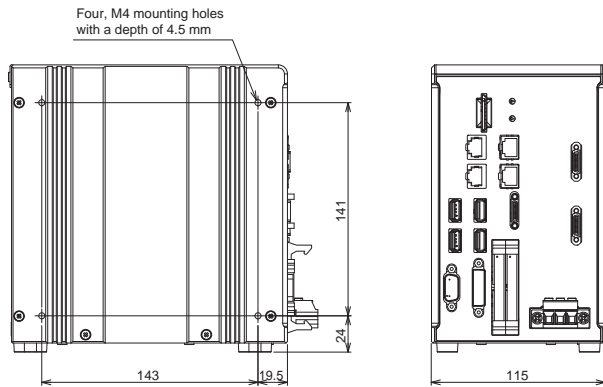

Camera cable (Ethernet cable, Straight)
FHV-VNBX2 □M

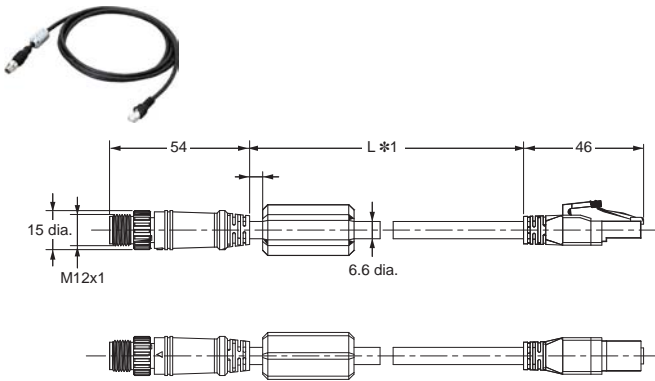

* Cable is available in 5 m/10 m.

Camera cable (Ethernet cable, Right-angle)
FHV-VNLBX2 □M

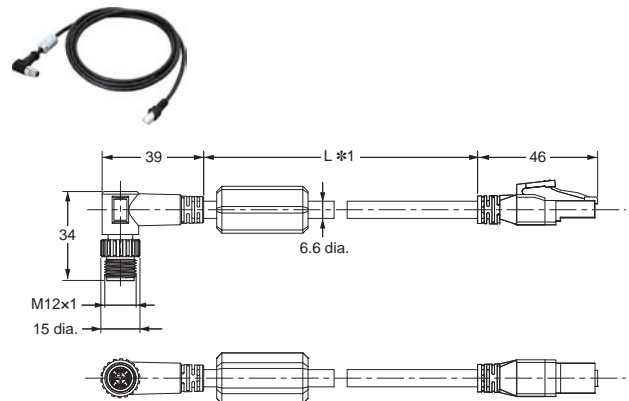

* Cable is available in 5 m/10 m.

Camera I/O Cables (Straight)
FH-VSDX-BX □M

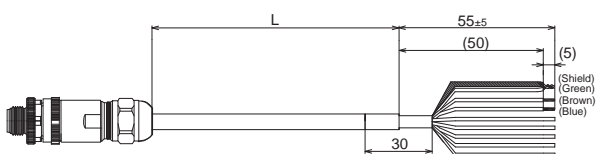

* Cable lengths (L) are 3 m/5 m/10 m.

Camera I/O Cables (Right-angle)
FH-VSDX-LBX □M

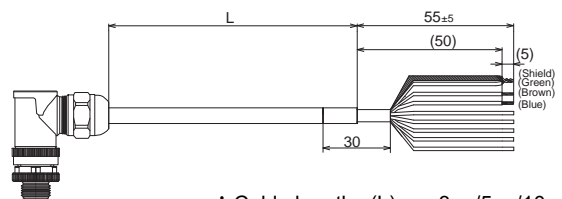

* Cable lengths (L) are 3 m/5 m/10 m.

Calibration Targets

Handeye Calibration Target FH-XCAL-R

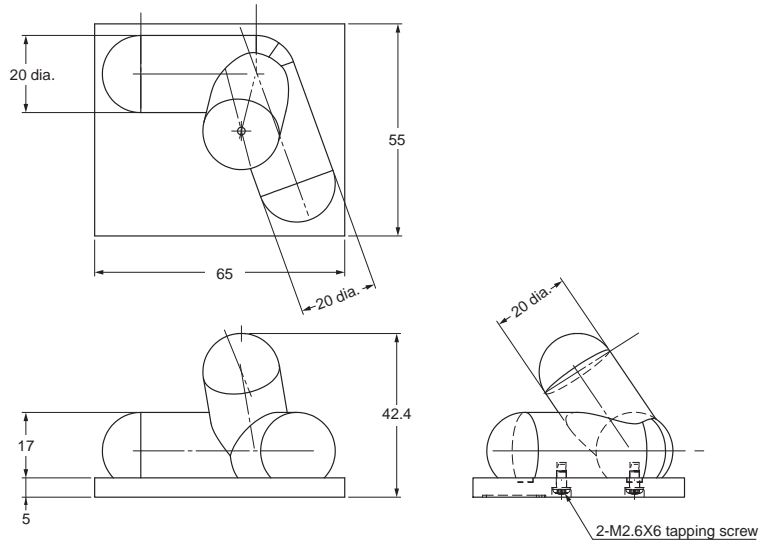

Camera Calibration Target FH-XCAL-S

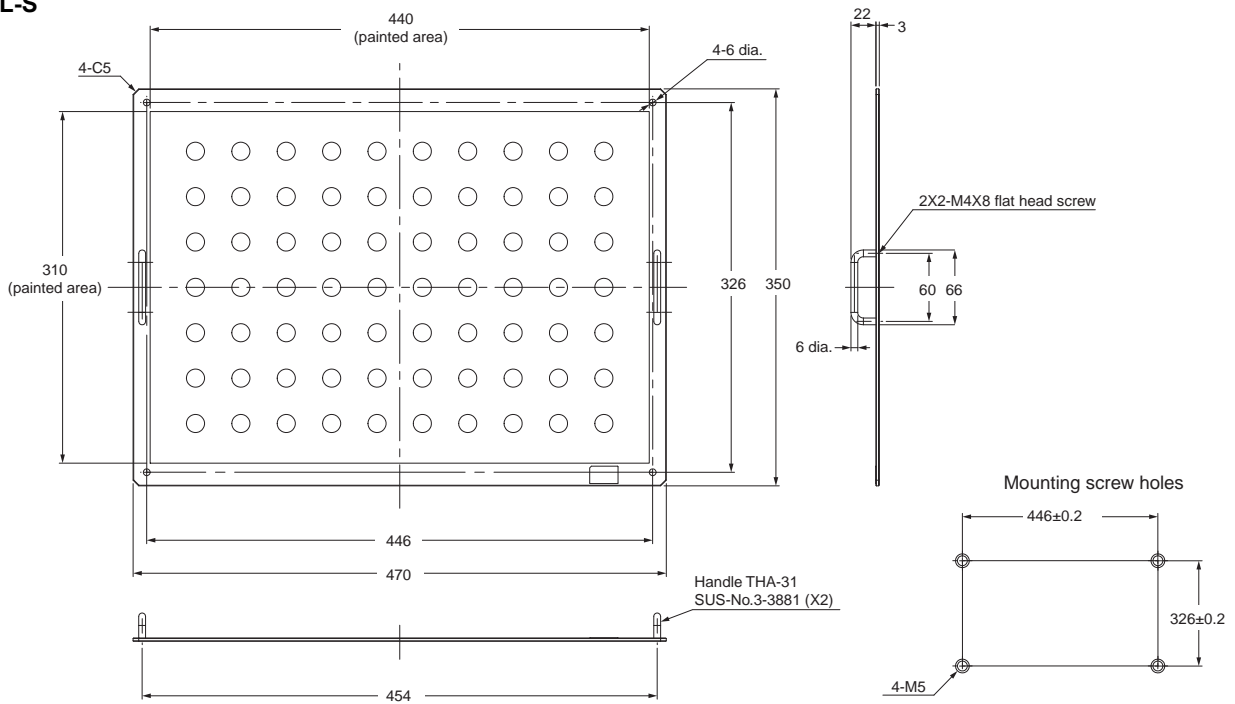

Parallel I/O Cable XW2Z-S013-□

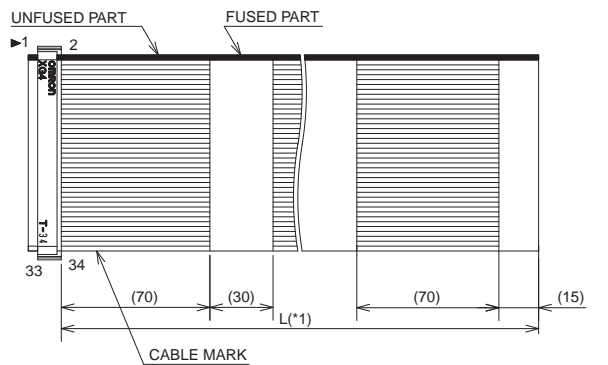

*1. Cable is available in 2m/5m.

**Touch Panel Monitor
FH-MT12**

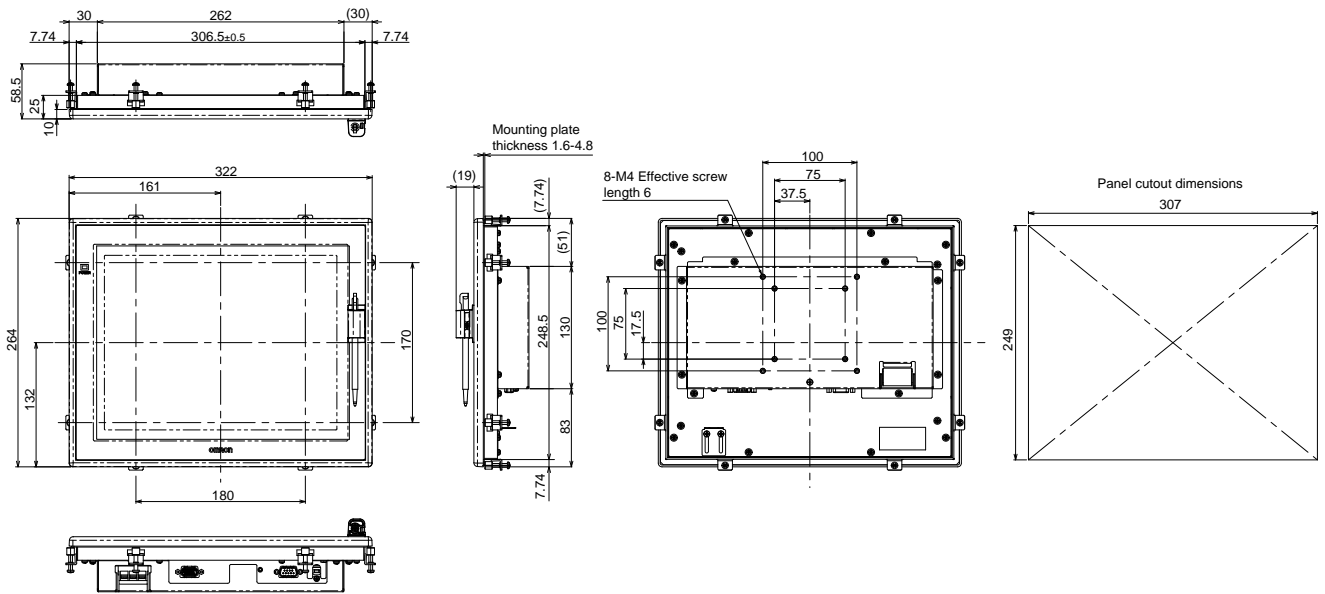

**DVI-Analog Conversion Cable for Touch Panel Monitor/LCD Monitor
FH-VMDA**

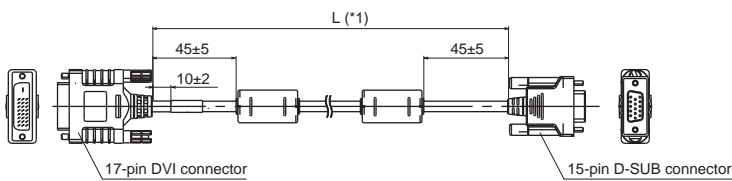

*1. Cable is available in 2 m/5 m/10 m.

**RS-232C Cable for Touch Panel Monitor
XW2Z-□□□PP-1**

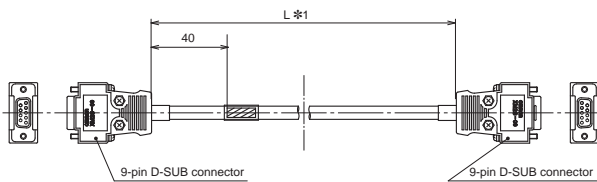

*1. Cable is available in 2 m/5 m/10 m.

**USB Cable for Touch Panel Monitor
FH-VUAB**

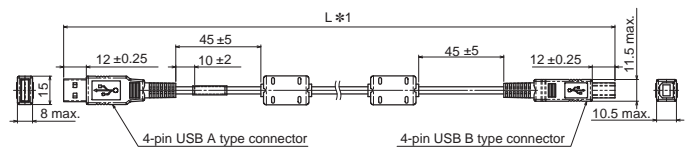

*1. Cable is available in 2 m/5 m.

**LCD Monitor
FZ-M08**

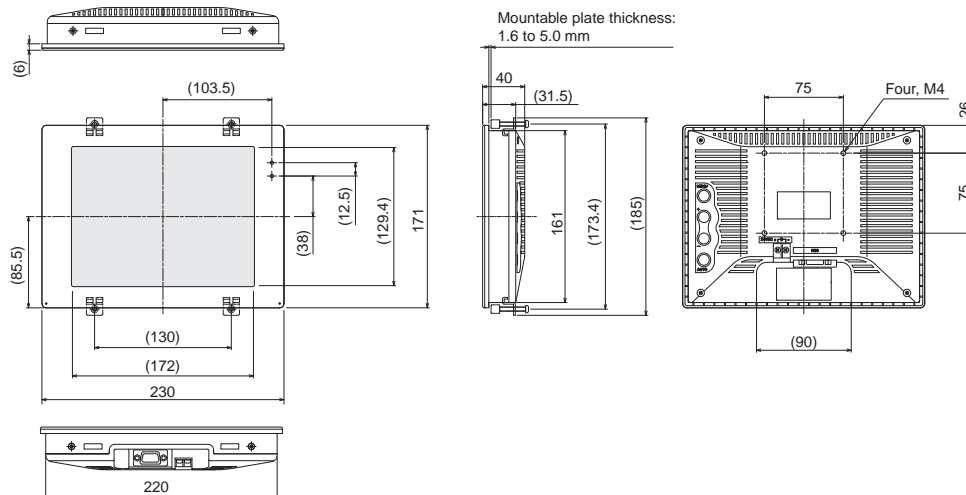

FH-SMD Series

Measurement Range and Field of View

Measurement range

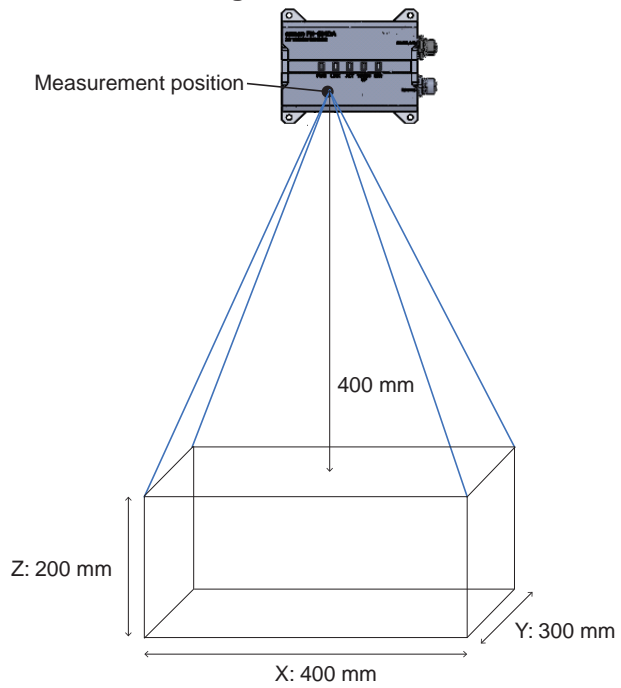

Measurement range (X, Y, Z)	400 x 300 x 200 mm
WD	400 mm

Measurement position

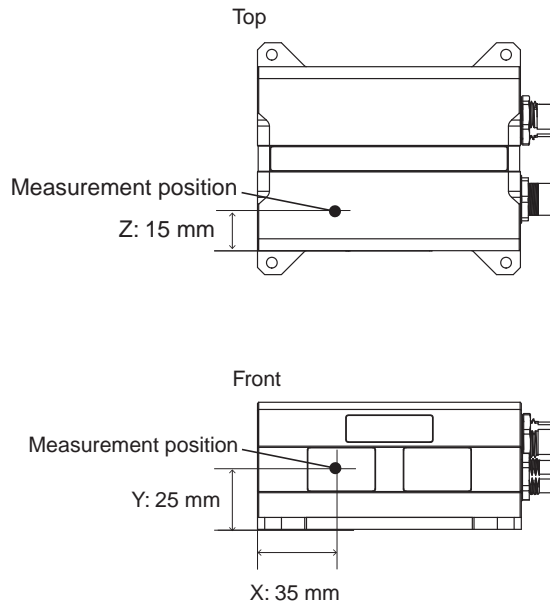

Related Manuals

Man.No.	Model	Manual
Z446	FH-5050/FH-SMDA-GS050B	Vision System FH Series 3D Robot Vision Application Construction Guide
Z436	FH-5050/FH-SMDA-GS050B	Vision System FH Series Hardware Setup Manual for 3D Robot Vision
Z445	FH-5050/FH-SMDA-GS050B	Vision System FH/FHV7 Series Processing Item Function Reference Manual for 3D Robot Vision
Z365	FH-5050	Vision System FH/FHV7 Series User's Manual
Z341	FH-5050	Vision System FH/FHV7 Series Processing Item Function Reference Manual
Z367	FH-5050	Vision System FH Series Macro Customize Functions Programming Manual
Z342	FH-5050	FH/FHV7 Series User's Manual for Communications Settings

- EtherCAT® is a registered trademark and patented technology, licensed by Beckhoff Automation GmbH, Germany.
- EtherNet/IP® is a trademark of ODVA.
- Microsoft® Visual Studio® and Windows are either registered trademarks or trademarks of Microsoft Corporation in the United States and/or other countries.
- QR code is the registered trademark of DENSO WAVE.
- Intel and the Intel logo are trademarks of Intel Corporation in the U.S. and/or other countries.
- The SD Logo is a trademark of SD-3C LLC.
- Other company names and product names in this document are the trademarks or registered trademarks of their respective companies.
- The product photographs and figures that are used in this catalog may vary somewhat from the actual products.
- Microsoft product screen shot(s) used with permission from Microsoft Corporation.
- The permission of Shutterstock.com was received for images that were used.

Terms and Conditions Agreement

Read and understand this catalog.

Please read and understand this catalog before purchasing the products. Please consult your OMRON representative if you have any questions or comments.

Warranties.

(a) Exclusive Warranty. Omron's exclusive warranty is that the Products will be free from defects in materials and workmanship for a period of twelve months from the date of sale by Omron (or such other period expressed in writing by Omron). Omron disclaims all other warranties, express or implied.

(b) Limitations. OMRON MAKES NO WARRANTY OR REPRESENTATION, EXPRESS OR IMPLIED, ABOUT NON-INFRINGEMENT, MERCHANTABILITY OR FITNESS FOR A PARTICULAR PURPOSE OF THE PRODUCTS. BUYER ACKNOWLEDGES THAT IT ALONE HAS DETERMINED THAT THE PRODUCTS WILL SUITABLY MEET THE REQUIREMENTS OF THEIR INTENDED USE.

Omron further disclaims all warranties and responsibility of any type for claims or expenses based on infringement by the Products or otherwise of any intellectual property right. (c) Buyer Remedy. Omron's sole obligation hereunder shall be, at Omron's election, to (i) replace (in the form originally shipped with Buyer responsible for labor charges for removal or replacement thereof) the non-complying Product, (ii) repair the non-complying Product, or (iii) repay or credit Buyer an amount equal to the purchase price of the non-complying Product; provided that in no event shall Omron be responsible for warranty, repair, indemnity or any other claims or expenses regarding the Products unless Omron's analysis confirms that the Products were properly handled, stored, installed and maintained and not subject to contamination, abuse, misuse or inappropriate modification. Return of any Products by Buyer must be approved in writing by Omron before shipment. Omron Companies shall not be liable for the suitability or unsuitability or the results from the use of Products in combination with any electrical or electronic components, circuits, system assemblies or any other materials or substances or environments. Any advice, recommendations or information given orally or in writing, are not to be construed as an amendment or addition to the above warranty.

See <http://www.omron.com/global/> or contact your Omron representative for published information.

Limitation on Liability; Etc.

OMRON COMPANIES SHALL NOT BE LIABLE FOR SPECIAL, INDIRECT, INCIDENTAL, OR CONSEQUENTIAL DAMAGES, LOSS OF PROFITS OR PRODUCTION OR COMMERCIAL LOSS IN ANY WAY CONNECTED WITH THE PRODUCTS, WHETHER SUCH CLAIM IS BASED IN CONTRACT, WARRANTY, NEGLIGENCE OR STRICT LIABILITY.

Further, in no event shall liability of Omron Companies exceed the individual price of the Product on which liability is asserted.

Suitability of Use.

Omron Companies shall not be responsible for conformity with any standards, codes or regulations which apply to the combination of the Product in the Buyer's application or use of the Product. At Buyer's request, Omron will provide applicable third party certification documents identifying ratings and limitations of use which apply to the Product. This information by itself is not sufficient for a complete determination of the suitability of the Product in combination with the end product, machine, system, or other application or use. Buyer shall be solely responsible for determining appropriateness of the particular Product with respect to Buyer's application, product or system. Buyer shall take application responsibility in all cases.

NEVER USE THE PRODUCT FOR AN APPLICATION INVOLVING SERIOUS RISK TO LIFE OR PROPERTY OR IN LARGE QUANTITIES WITHOUT ENSURING THAT THE SYSTEM AS A WHOLE HAS BEEN DESIGNED TO ADDRESS THE RISKS, AND THAT THE OMRON PRODUCT(S) IS PROPERLY RATED AND INSTALLED FOR THE INTENDED USE WITHIN THE OVERALL EQUIPMENT OR SYSTEM.

Programmable Products.

Omron Companies shall not be responsible for the user's programming of a programmable Product, or any consequence thereof.

Performance Data.

Data presented in Omron Company websites, catalogs and other materials is provided as a guide for the user in determining suitability and does not constitute a warranty. It may represent the result of Omron's test conditions, and the user must correlate it to actual application requirements. Actual performance is subject to the Omron's Warranty and Limitations of Liability.

Change in Specifications.

Product specifications and accessories may be changed at any time based on improvements and other reasons. It is our practice to change part numbers when published ratings or features are changed, or when significant construction changes are made. However, some specifications of the Product may be changed without any notice. When in doubt, special part numbers may be assigned to fix or establish key specifications for your application. Please consult with your Omron's representative at any time to confirm actual specifications of purchased Product.

Errors and Omissions.

Information presented by Omron Companies has been checked and is believed to be accurate; however, no responsibility is assumed for clerical, typographical or proofreading errors or omissions.

Note: Do not use this document to operate the Unit.

OMRON Corporation Industrial Automation Company

Kyoto, JAPAN

Contact : www.ia.omron.com

Regional Headquarters

OMRON EUROPE B.V.

Wegalaan 67-69, 2132 JD Hoofddorp
The Netherlands
Tel: (31) 2356-81-300 Fax: (31) 2356-81-388

OMRON ELECTRONICS LLC

2895 Greenspoint Parkway, Suite 200
Hoffman Estates, IL 60169 U.S.A.
Tel: (1) 847-843-7900 Fax: (1) 847-843-7787

OMRON ASIA PACIFIC PTE. LTD.

438B Alexandra Road, #08-01/02 Alexandra
Technopark, Singapore 119968
Tel: (65) 6835-3011 Fax: (65) 6835-3011

OMRON (CHINA) CO., LTD.

Room 2211, Bank of China Tower,
200 Yin Cheng Zhong Road,
PuDong New Area, Shanghai, 200120, China
Tel: (86) 21-6023-0333 Fax: (86) 21-5037-2388

Authorized Distributor:

©OMRON Corporation 2021-2024 All Rights Reserved.
In the interest of product improvement,
specifications are subject to change without notice.

CSM_5_2

Cat. No. Q298-E1-10 0324 (0221)