

FQ2 Smart Camera

The New Standard for Image Inspection



» Advanced inspection in a compact housing

» Expanded performance and functionality

» Camera, Communications, Software Tools, and Much More

Introducing the Smart Heavyweight

Inspection capabilities, camera options, and communication options -- this powerful heavyweight has it all.

This Vision Sensor provides all of the best-selling features found in high-end models without the need as in vision system for a separate controller. This new Smart Camera was designed to attract potential customers to try the FQ2 Series.



Code Reader	High-speed image processor	Megapixel capacity	Real color	Monochrome	C-mount	9 inspection items	11 image filters	32-camera expansion	360° position compensation	Ultra-wide field of view	DAP partial input
OCR	HDR	Sub-pixel processing	High-power lighting	IP67	E-IP	PLC Link	FINS	34 I/O points	RS-232C	Password	Image inversion

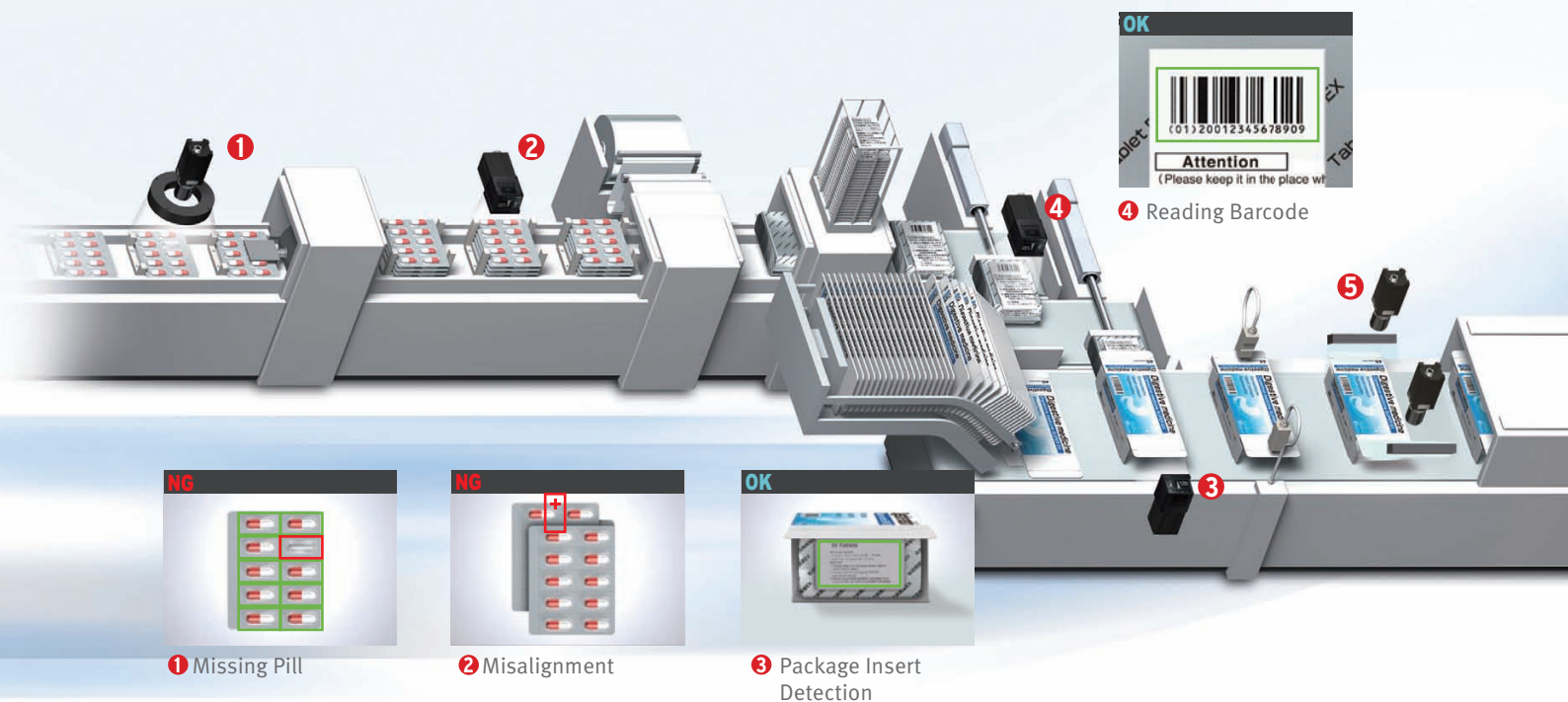

Three Improvements for an effective Machine Design

Compact Body

All in one Vision Sensor

All-in-one compact size that is perfect for use in tight spaces or as an aftermarket option. Compared to more-advanced Vision Sensors with multiple components, this Sensor boasts a much more efficient hardware design.



» p.04

Extended Functions

Image Sensor, OCR, and Code Reader in One

The OCR function, with a "build-in" dictionary and the Code Reading, ability to recognize 15 codes types add to the solution and provide a powerful upgrade !

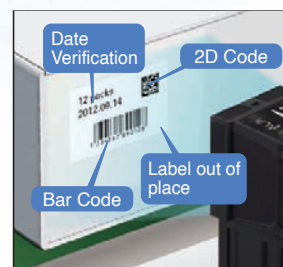

» Image Inspections p.06
 » OCR p.08
 » Code Reader p.10

Diverse Lineup

A Lineup That Fits a Wide Range of Equipment

Expanded inspection menu, camera variations, and communication interfaces with the same pricing level as our previous FQ Series. With a wide range of sensors, an option for every application now becomes a standard option.



» p.12

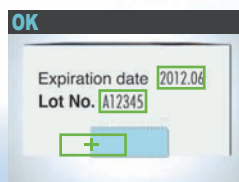
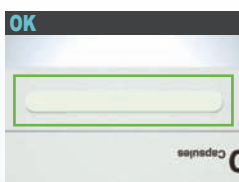

5 Hot-melt Detection

6 Date Verification and Tape Detection

7 Reading Barcode

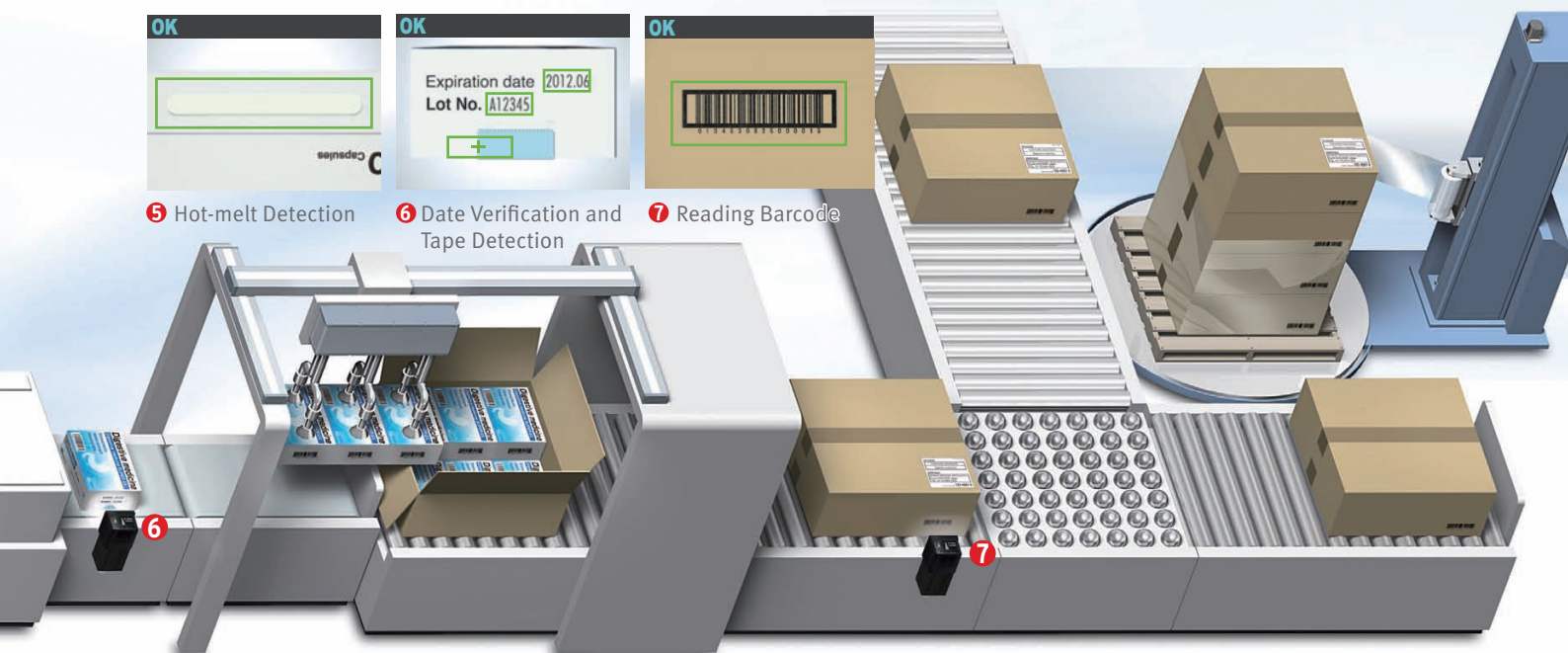

Compact

All You Need is One

All You Need in One Package

Image Processor

Although previous Vision Sensors placed the image processor in a separate Controller, now we have built the processor into the camera unit.

High-power Lighting

The Sensor includes high-power lighting capable of evenly lighting across a wide field of view. This provides sufficient lighting even when the enclosed polarizing filter is used.

Adjustable lens

The focus of the lens can be adjusted to take clear images for the specific field of view and installation distance you need.

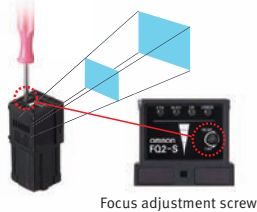

I/O Power Supply Connector

The external output line for inspection results, the input line for changing the setup, and the power supply line are all combined into one connector.

Ethernet Connector

Commands can be input from a PLC to control the FQ2, and inspection results and measurement results can be output from the FQ2 to a PLC. You can also transfer images to a computer.



IP67 Water Resistance



The sensor can be used in wet environments.

Flexible Cables



All cables from the camera are flexible. This allows the Sensor to be used safely on moving parts.

Smart Click Connectors

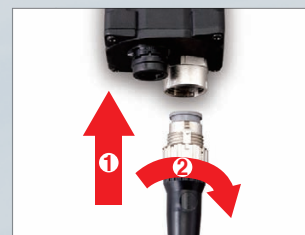

Connection is made quick and easy with a clear, definitive click-into-place mechanism.

Quick and Easy Design and Installation

Easy Product Selection

All you need to do is select the camera based on the field of view and installation distance that you require. There is no need to select and purchase additional lighting or lenses. Furthermore, the time required to wire everything has been drastically reduced due to the low number of components.

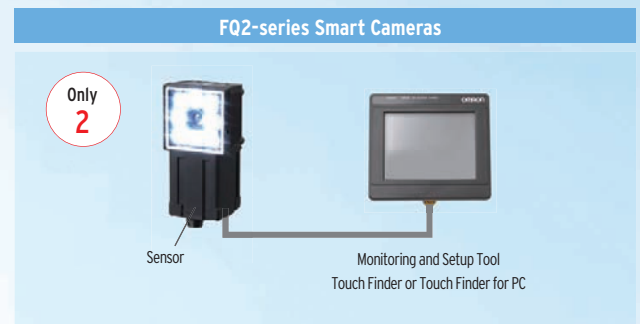
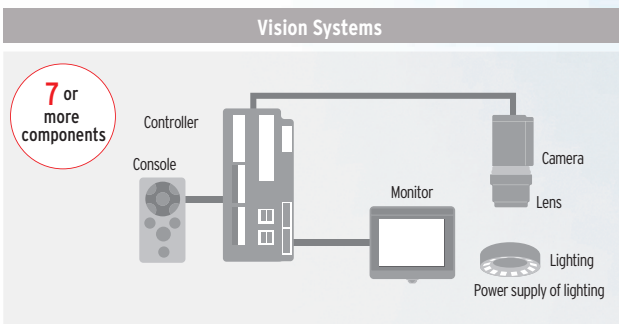

Easy Installation

The camera and lighting have been integrated into a single unit, so only one camera mounting bracket is required. The Sensor comes with a multi-directional mounting bracket that can be attached on any of the four sides of the Camera. Axis alignment is also not required because the lighting and the camera are integrated into a single unit.

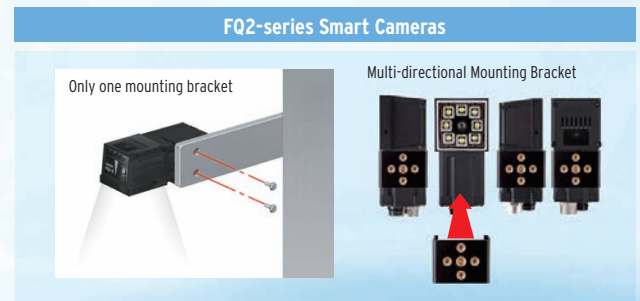
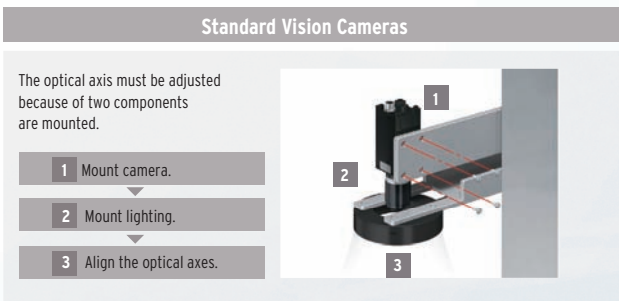

Easy Expansion Up to 32 Cameras

Just install the Cameras where you need them. No control panels are required to house the controllers. Triggers can be input for each Camera, so new Cameras can be added whenever required without having to worry about timing input design. Up to 32 Cameras can be set up from a single Touch Finder, so you do not need to worry about adding new monitors when you need more Cameras. This also allows you to smoothly respond to user requests for additional features.

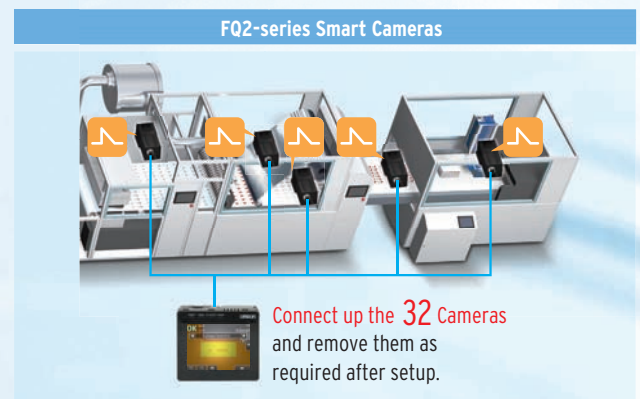
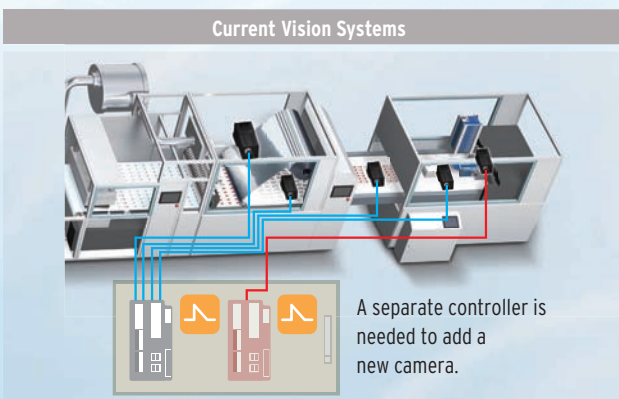

Extended Functions : Image Inspections

Easily Perform Both Inspection and Positioning

You can combine multiple inspection items to perform external inspections, positioning, and other tasks all from a single Sensor.

External Inspection

External inspection of ICs can be completed with a single Sensor. The position offset of the entire pallet before inspection can be adjusted on the image itself, which reduces the amount of work required to increase mechanical positioning accuracy.

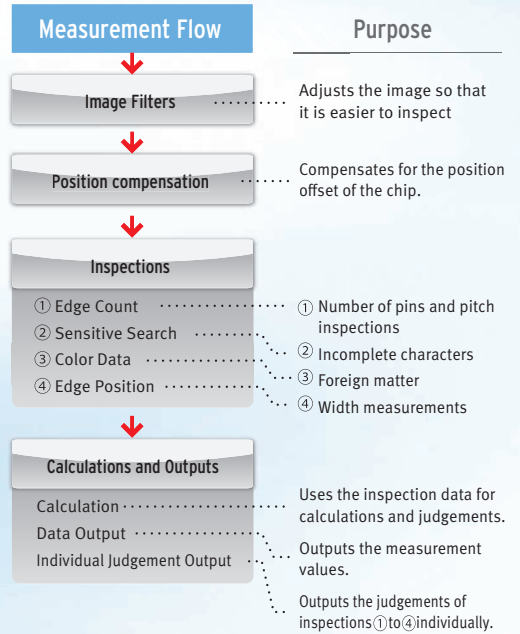
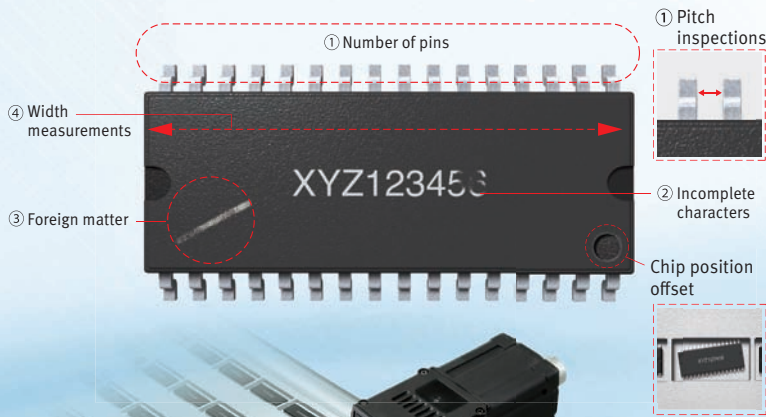

Component Positioning

The Sensor can measure angles of rotation and other position information, so it can also be used for positioning. Inspections can also be performed for the number and size of holes along with the position information.

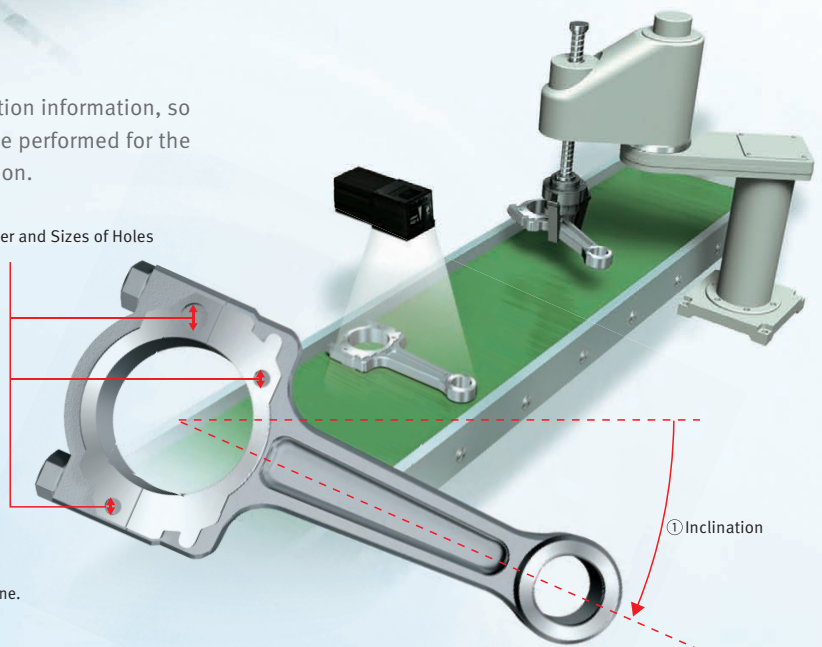
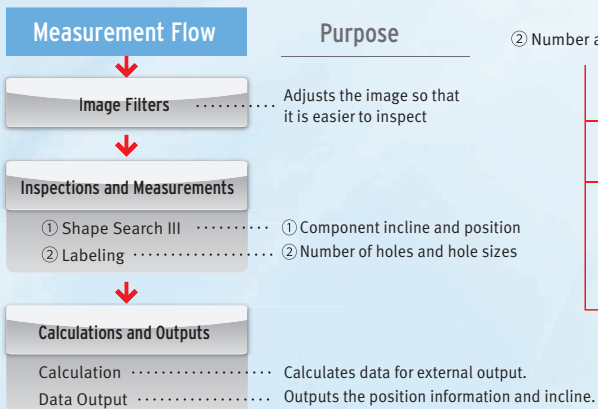

Incorporating the Best-selling Inspection Items from High-end Vision Systems

Searching



Shape Search III

The FQ2 now has Shape Search III that uses OMRON's unique techniques to search and match registered models at high speed. Shape Search III provides advanced robustness, which is critical on FA sites. High-precision and reliable position detection is possible without being affected by light interference and backgrounds.

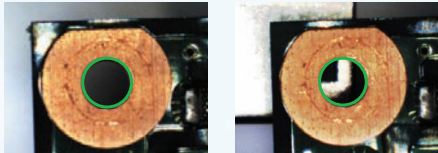

The target object can be detected precisely even with the background.



Multiple objects can be detected simultaneously even with different amounts of light.

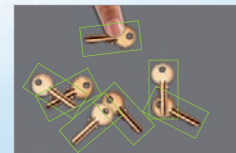

Stable 360° searching is possible even if objects are overlapped or partially hidden.

Searching

Search

This is a standard search inspection item. This type of search is used to detect items like labels, identify shapes, or positions.



Detection of Promotional Stickers

Sensitive Search

The model image can be automatically divided into small areas, so that tiny differences that cannot be detected with a normal search can be detected with large numerical differences.

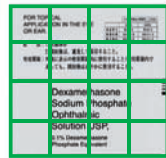

Edge Pitch

Edge Pitch

The number of edges in a region can be counted.

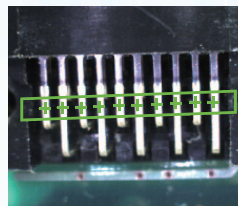

Edge Position

This inspection item detects Edges and measures their positions.

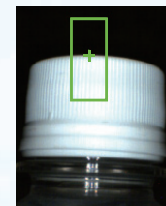

Edge Width

This inspection item measures the width between edges.



Area Measurements, Color Measurements, and Defect & Foreign Matter Detection

Labeling

This inspection item counts how many labels there are of the specified color and size and measures the area or center position of the specified label.



Area

This inspection item measures the area and center position of the specified color.

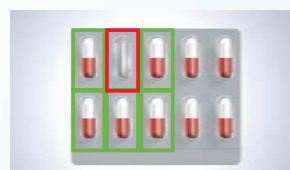

Color Data

Inspections can be performed that compare the difference in color between the workpiece and a registered image of a good product to detect objects and foreign matter.(average color value)

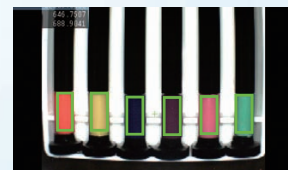

You can also inspect for defects and foreign matter by looking at the color deviation.(color deviation)

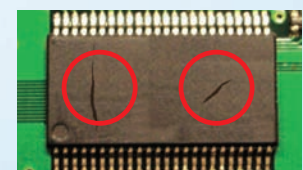

Utility Items

360° Rotational Position Compensation

The correct position of workpieces with an inconsistent orientation can be measured through automatic detection of the offset of the workpiece in relation to a registered standard model.



Image Filters

A total of 11 different image filters are provided, including background suppression to help eliminate patterns that can result in unstable measurements, as well as dilation and erosion.

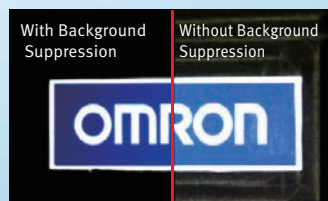

Calibration

If the dimensions or position of a workpiece is difficult to determine in a pixel display, you can convert the display unit so that it is easier to see.

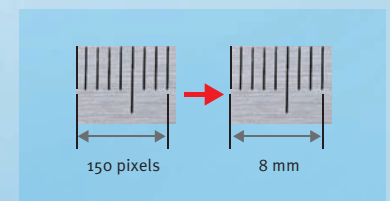

Extended Functions : OCR

New OCR Method to Quickly Read Characters without Dictionary Registration



Date Verification

Even if printing is distorted or unclear due to conveyor line conditions, a unique reading method with a built-in dictionary enables stable reading of characters.

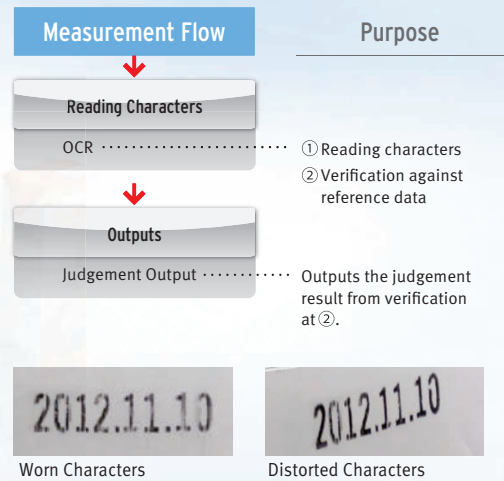

Character Recognition and Label Position Inspection

Although previously performed as separate processes, character recognition and inspection tools can now both be performed with a single FQ2 Sensor. This helps you reduce costs and save space.

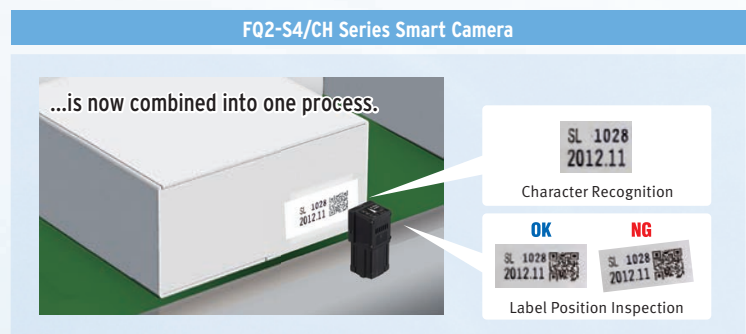
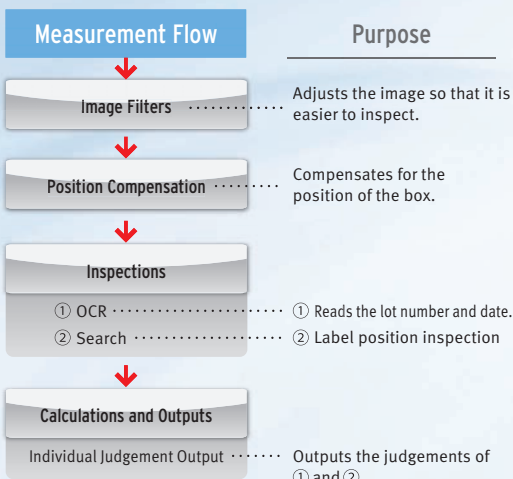
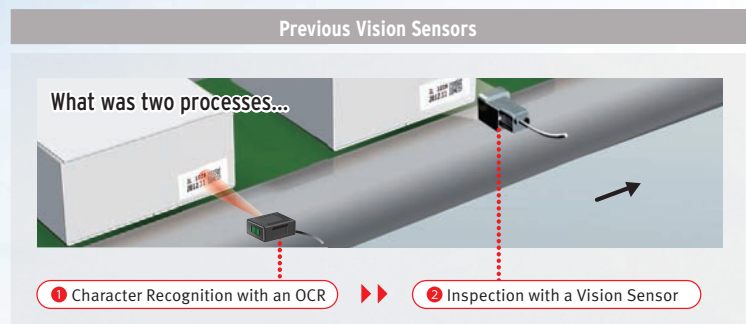

OCR with Built-in Dictionary

OCR

The large amount of data in the built-in dictionary contains approximately 80 different fonts that are used on FA sites. Variations for worn characters, blurring, distortion, different backgrounds, and size changes have been included to enable stable and highly accurate reading with the built-in dictionary even for some variations in the characters. It is not necessary to set parameters to compensate for character contrast or positional offsetting.

Conventional OCR

Time is required for character registration in the dictionary.

FQ2 OCR

The built-in dictionary eliminates the need for character registration in the dictionary, significantly reducing setup time.

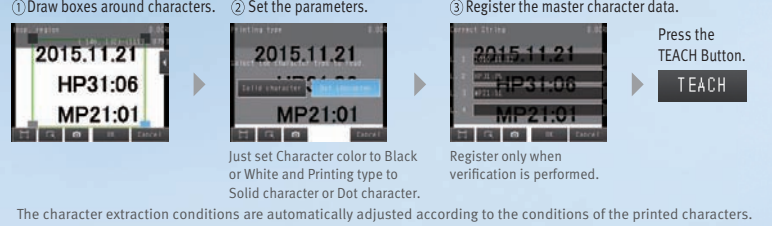

Reading is started.

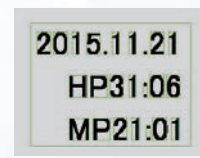

Different printers use different printing devices.

Characters from most printers, including dot and impact printers, can be read with the built-in dictionary. Handles Approx. 80 Fonts



Worn and inclined characters cannot be read.

Unique recognition technology enables stable recognition of worn or distorted characters.

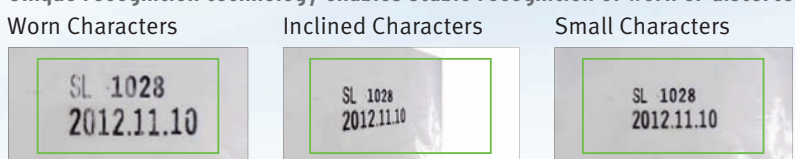

Touching and curved characters cannot be read.

Touching characters and curved character strings can be segmented correctly.

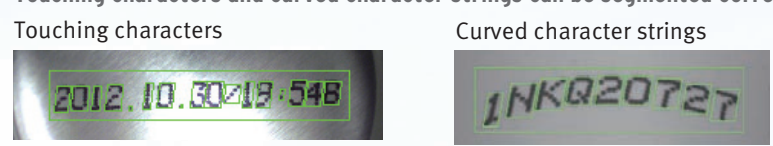

Utilities That Make Daily Operation Easier

Verification

The character data being read can be verified against the character data registered in the master data. You can register up to 32 character strings in the master data and easily change the current master data with an external signal. With the FQ2-S4, you can also compare against the character strings read from bar codes or 2D codes.

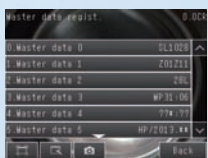

Calendar Function

The calendar function eliminates the need to set the date and best-before date manually every day. You can also set the dates according to the dates set to the printer by using the command sent from the external system in addition to from the Touch Finder for the FQ2.



Registration in Model Dictionary

Non conventional characters can be added to the dictionary. Special fonts are difficult to read with the default settings, but add them to the dictionary and the FQ2 provides reliable readings.

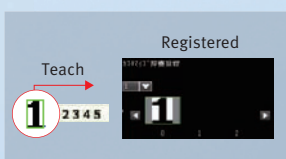

Logging Images and Reading Data

The inspected images and reading results can be temporarily saved in the sensor. Additionally, up to 10,000 images and 10,000,000 reading results can be saved in a 4-GB SD card. You can select logging both OK and NG results or only NG results to aid in traceability.

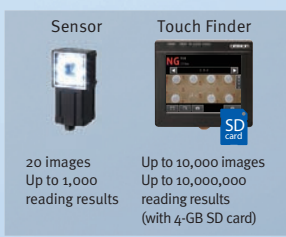

Boundary Correction

Dark areas around characters, such as bar codes, are removed to achieve stable reading.

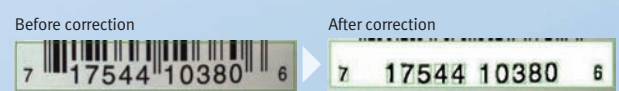

Expanded Functions : Code Reader

Read Any of 15 Types of Codes from Paper Labels to Direct Marking

Code and Character Verification

OCR and Code Reading inspection items can be combined to read codes and verify them against character strings all within the FQ2. No programming of external devices is required.

JAN/EAN/UPC	Code39	Pharmacode
ITF(Interleaved 2 of 5)	Code93	Code128 / GS1-128
GS1-DataBar	GS1-128 Composite Code	Codabar(NW-7)
Data Matrix	Micro PDF417	Micro QR Code
PDF417	QR Code	GS1-DataMatrix

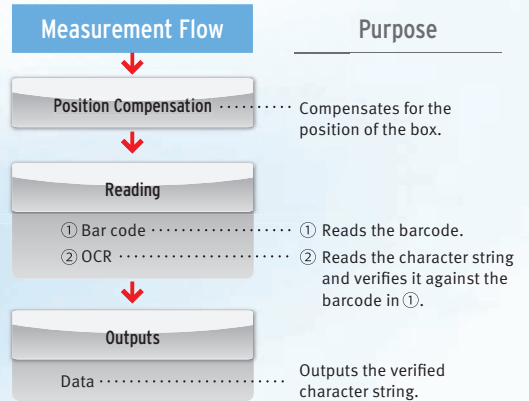

Reading Direct Marking Codes

It has become common to manage information by directly marking codes on products. However, differences in materials often causes instability when reading the printed characters. The FQ2 achieves stable reading with unique functionality designed just for DPM.

Data Matrix(ECC200)
QR Code

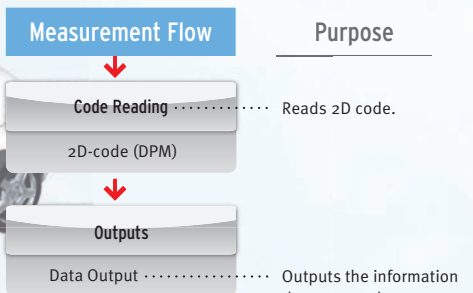
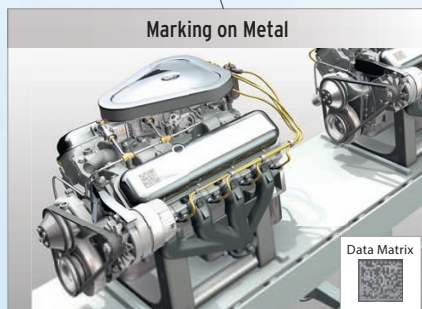
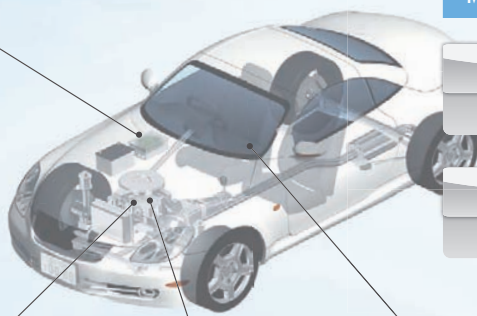
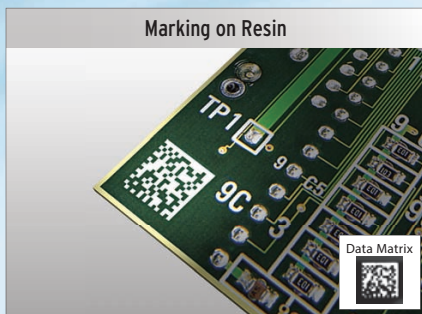

• **Print Quality Grading Function**

The function to evaluate the quality of a 2D code (DataMatrix) enables an in-line check of the relative quality change and the parameter where the change occurred.

[Applicable standards] ISO/IEC TR 29158 (AIM DPM-1-2006)

[Applicable code] DataMatrix ECC200

Note This function evaluates relative change in code quality and does not give absolute grading. The FQ2-S4 with sensor version 2.20 or later provides this function.

• **Types of Filtering**

You can apply up to three of the four unique filters developed by OMRON in the desired order to remove printing irregularities and noise, in order to achieve a stable reading.

Smooth	Smooths the image.
Dilate	For white codes, increases the cell size. Effective for reading codes with cell spreading.
Erosion	For white codes, reduces the cell size. Effective for reading separated dot codes.
Median	Removes noise.

Combining Filtering

Erosion and dilation can be combined to connect dots without changing the dot thickness.



• **Retry function**

Code Readers must be able to read codes even for poor printing conditions. You can automatically retry reading while changing the exposure time and other reading conditions, even for changing workpieces or environments, to enable a stable reading.

1 Retrying the Specified Number of Times with the Same Conditions

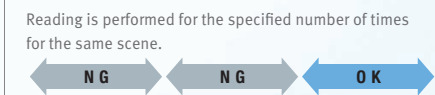

3 Retrying While Changing the Shutter Speed

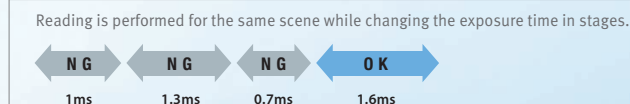

2 Retrying While External Trigger Is Input

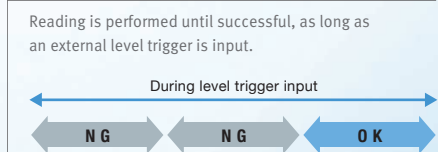

4 Retrying While Changing the Reading Conditions

When reading DPM codes, inconsistencies in printing conditions can result in NGs if reading is performed with only one set of reading settings. The FQ2 allows you to register up to 32 sets of reading conditions as scenes and retry reading while changing the scenes in order. The system automatically determines the scenes with the highest usage rates and changes the order to start with them to flexibly handle changes in reading conditions. Of course you can specify a fixed order if required.

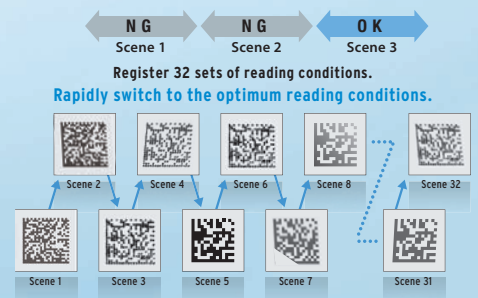

Versatile

A Lineup That Fits a Wide Range of Equipment

Sensor

We offer a diverse lineup of Sensors so that you can choose the one with the perfect field of view and installation distance for your needs.

Integrated Sensor



• Seamless Field of View Variations

All-in-one Sensors tend to be limited in field of view variations, but we offer a lineup ranging from 7.5 mm up to 240 mm to meet your needs.

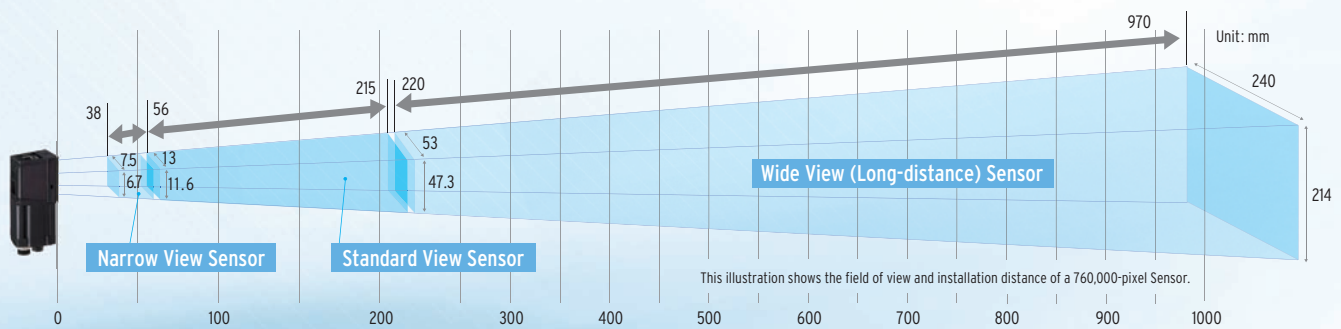

• Wide View Sensors -- Perfect for Tight Spaces

A side-view wide-angle camera takes images and performs inspections across a wide area, even if the camera is close to the workpiece. Perfect for mounting the sensor in locations with limited space. This also enables the Sensor to be installed alongside an assembly line without protruding in order to perform inspections from the side of the conveyor belt.

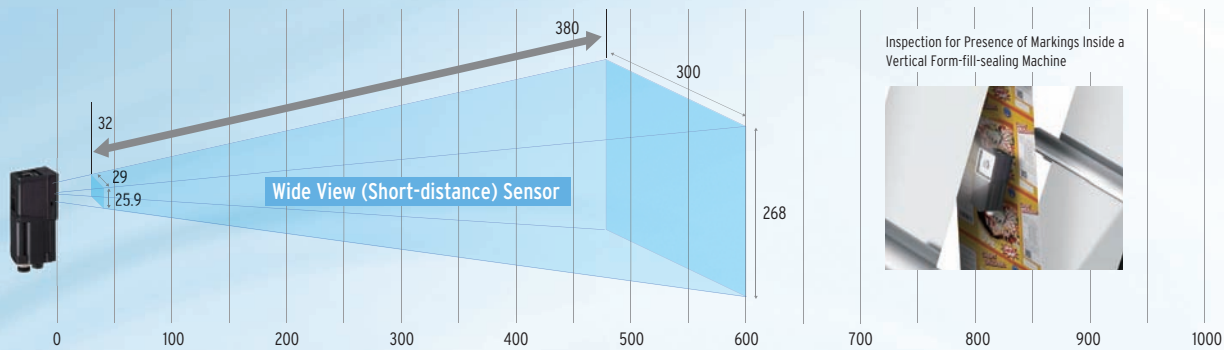

Sensors with C-mount lens

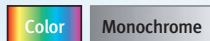

The Sensors with C-mount lens enable freedom of lens selection for long distances over 1 m and narrow fields of view under 1 mm that are not covered by our integrated Sensors. This type of Sensor is also useful when you want to use external illumination.

Long Distance



Narrow Field of View



Note: A commercially available telecentric lens is required for narrow field of view applications.

Lighting Examples

Backlighting



External Shape Inspections

Low-angle Lighting

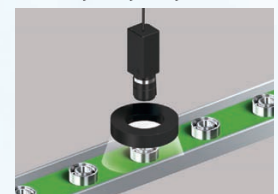

Defect and Foreign Matter Inspections

Communication Interfaces

The Sensor includes communication interfaces for compatibility with a wide range of host devices. This helps reduce the design work required for data communications between the Sensor and a PLC.

Note: The type of communications interface depends on the model of the Sensor. Refer to page 22 for details.



PLC Link

PLC link greatly reduces the amount of time and work that is required to create ladder programs.

Compatible Models

OMRON PLCs: CS, CJ1, CJ2 and CP1 Series
Mitsubishi Electric PLCs: Q Series

FINS

OMRON's exclusive FINS/TCP communications interface can be used to connect to low-cost OMRON PLCs. With this communications interface, no communications controls are required to process the sending and receiving of complex TCP packets. You get faster, simpler connections to OMRON PLCs.

Compatible Models

OMRON PLCs: CS, CJ1, CJ2 and CP1 Series

EtherNet/IP™

EtherNet/IP™ communications, a standard widely used in communications systems in factories around the world, is also supported. This communication interface enables simple and easy connections to a wide range of EtherNet/IP™ devices, including OMRON PLCs.

Compatible Models

OMRON Machine Automation Controllers: NJ Series
OMRON PLCs: CS, CJ1 and CJ2 Series

I/O Expansion Units

Our expansion units enable expansion to up to three times the number of I/O connections. This enables the output of individual judgement results for each inspection, a feature that has been highly requested.

RS-232C Communications Unit

This Sensor Data Unit supports standard RS-232C communications.

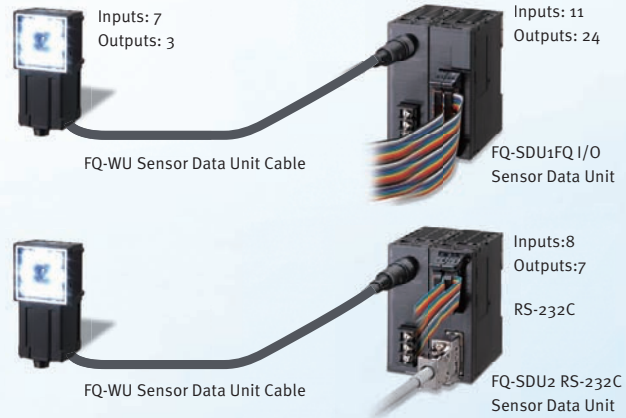

Operation Interfaces

You can choose the operation interface and monitor size to suit your application.

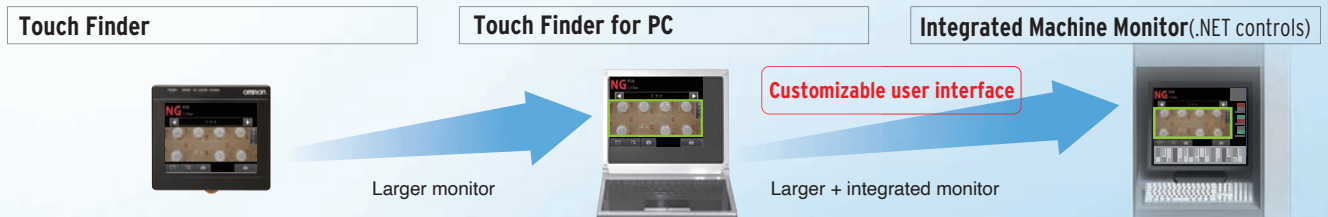

This is a small monitor with a touch panel. It's durable, rugged design is shock-resistant and portable. It has passed our standard 1.3 m drop test. On-screen messages can be changed between nine different languages: English, Traditional Chinese, Simplified Chinese, Korean, Japanese, German, French, Italian, and Spanish.

The Setup Tool provides the same functions as those on the Touch Finder, but on a PC. In addition, offline simulation can be performed without the need of a sensor. The software can be downloaded for free by any customer with the purchase of a Sensor. Refer to the member registration sheet that is enclosed with the sensor for details.

Customizing user interface using .NET controls* makes the onsite monitor easier to read. You can increase or reduce the size of displayed measurement images and text to meet the demands of onsite operators.

*.Custom controls to easily display images and results measured by the FQ2 Series on applications created with Microsoft Visual Studio. The Microsoft® .NET software is used to connect users, information, systems, and devices.
•Microsoft .NET is either a registered trademark or trademark of Microsoft Corporation in the United States and/or other countries.
•EtherNet/IP™ is the trademark of ODVA.

Hardware Advancements

High-speed Image Processor

3X Faster than Previous Models

20 Inspection Items per Second Processing Time

With our new high-speed image processor we are able to achieve a processing time of 50 ms or less for all primary inspection items.

* Processing may take longer than 50 ms depending on the settings.

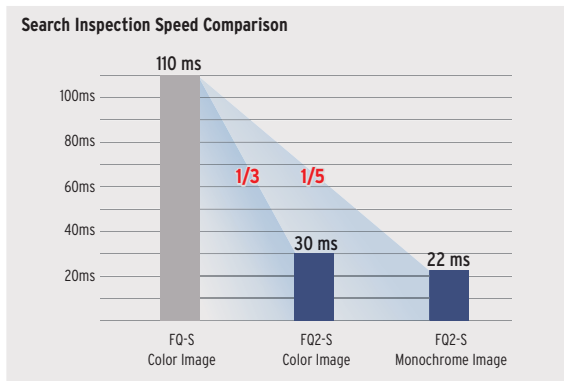

Note: This comparison was conducted with a 752 × 480 pixel image, with no rotational compensation.

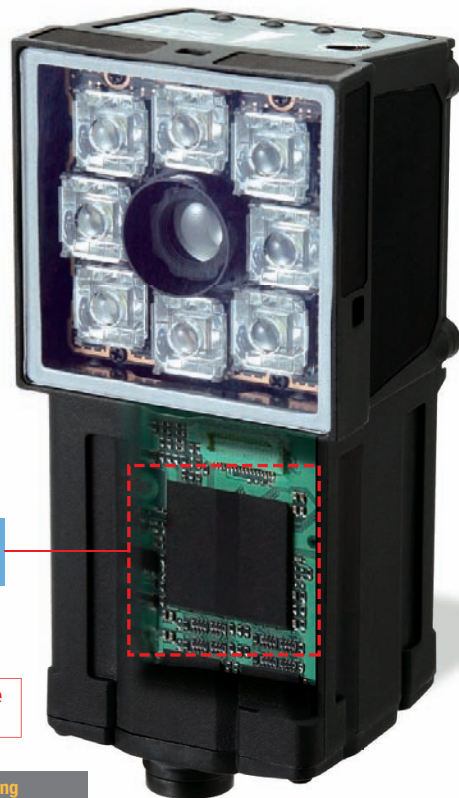

High-speed Image Processor

High-brightness ODR Lighting

Four Times the Brightness

Four times the brightness of conventional LEDs can be achieved with ODR lighting (Optical Double Reflection) that uses a complete new optics technology. High-brightness illumination was achieved by increasing light efficiency and heat dissipation, making it possible to input images this sharply for the first time.

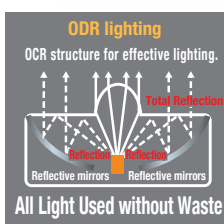

Crystal Clear Images Even through Polarizing Filter

Lighting is required for stable image inspection, but shiny surfaces can reflect light, resulting in incorrect judgments. You can use a polarizing filter to reduce specular reflection, but the entire image will be darker, which can result in insufficient image contrast. The FQ2 Series is equipped with OMRON's own high-power lighting DR optical system for effective use of LED power. This system provides sufficient lighting for inspection even when the enclosed polarizing filter is used.

<p>Standard Lighting Light is reflected.</p>	<p>Standard Lighting + Polarizing Filter The overall image is dark; inspection becomes unstable.</p>	<p>High-power Lighting + Polarizing Filter Overall image contrast is maintained, and only reflections are eliminated.</p>
---	---	--

Megapixel CMOS Sensor

4 Times the Pixels × **1,000 Times the Display Resolution**

(Comparisons to previous OMRON models)

Precision 1.3 Megapixel Camera

Would you like a little more positioning accuracy?
Do you need a wider field of view?
We hear you, and that is why we have greatly improved the resolution of our camera.
The 1.3 megapixels maintain precision and accuracy while also enabling a wider field of view.



350,000 pixels



1.3 megapixels



1.3 Megapixels	
Color	Monochrome

Sensor with C-mount

760,000 Pixels *	
Color	Monochrome

Integrated Sensor

* 350,000 pixels types are also available.

Sub-pixel Processing

Previously, position information could only be output on a per-pixel basis, but now you can output at a resolution even higher than the number of available pixels. This provides finer measurement values for travel distances and helps to improve positioning accuracy.

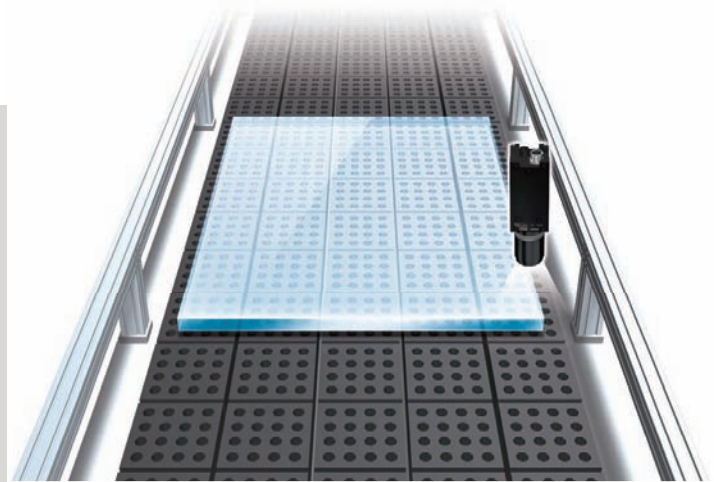
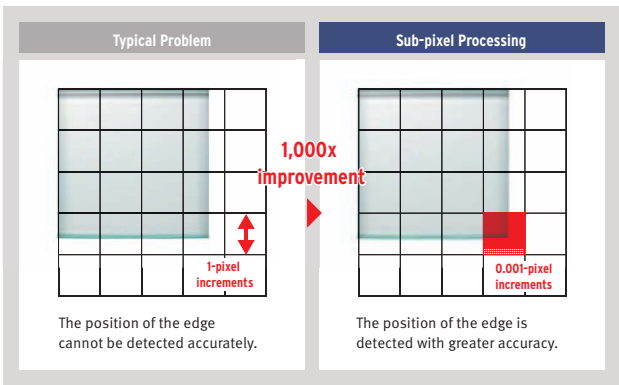

Partial Input with DAP (Dual Axis Partial) Processing

Processing time can be further reduced by limiting the camera input to only the area that is required for inspection. Previous models allowed trimming only in the Y direction, but now you can specify a range across both the X and Y axes for trimming. Keep a wide field of view and trim to only the sections that are required for inspection in each scene to reduce processing time.

[Problems with a Standard Digital Zoom]

Camera input is performed for all images and only a portion is shown enlarged, so this does not decrease the amount of time required for camera input.

Note: DAP processing is provided only on 760,000-pixel and 1,300,000-pixel Sensors.

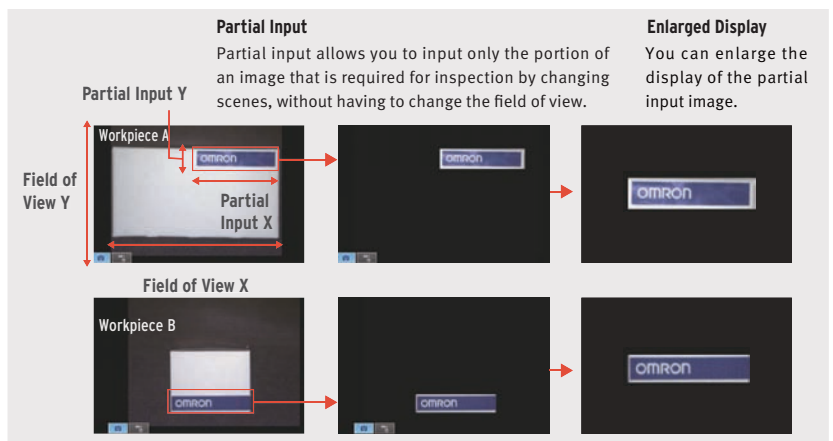

Useful Onsite Utilities

Simulation Software

Without connecting the FQ2 Sensor, TouchFinder for PC, setup software that runs on a PC, enables offline adjustment of inspection conditions and measurement simulation using logging images. You can verify and adjust from a remote location to increase yields in overseas factories.

Real-time Threshold Adjustment

The FQ2 smart camera allows fast and easy real-time parameter adjustment. Eliminating the need to stop the machine for fine tuning and optimisation of settings, resulting in zero machine downtime.

Auto Detection

When multiple sensors are connected to the touch finder, the display automatically switches to the image of the sensor which has produced an NG result. This allows dynamic visualisation of reject conditions.

Note. When 32 sensors are connected, the most recent NG sensor of 8 sensors selected for display is displayed.

Inspection History Logging

Historical results logging is very useful for testing a new line. Samples are fed down the line and inspection results are logged. The logged data can be checked on a time scale in graph form and used to adjust judgement conditions. File Logging is convenient during operation. Large inspection history can be saved on SD cards and used later for traceability.

Shortcuts

Shortcuts to Setup Menu items that are changed frequently can be added to the Run Mode display. This enables the user to quickly perform adjustments when a problem occurs during operation.

Key Technologies

Real-color Sensing

Real-color processing is an image processing technology that performs high-speed processing of full-color images with a total of 16.7 million colors (256 tones per RGB channel). This means that image processing can be performed with the same color information that is visible to the human eye, and stable measurements can be performed under lighting that closely resembles natural light.

Real color image processing

Color variations between 16.7 million different colors can be captured without any color loss.

The camera image is processed as-is without any loss of quality. This enables even the slightest of color differences to be captured with high accuracy.

Color Image Processing

Captured images are converted to a 256-shade monochrome image and processed. This enables more stable inspection compared to binary level processing, but slight changes in color cannot be detected with this method.

Binary image processing

Captured images are converted to a black and white two-color image and processed. This reduces the amount of data and enables high-speed processing.

← Previous Image Processing

← OMRON FQ2 Series

HDR Sensing

High dynamic range minimizes the effects of lighting such as halation and allows highly precise inspections.

Conventional images

Dynamic range of the upper image

Dynamic range of the lower image

Defects Undetectable Due to Overexposure or Underexposure
Any spot outside the dynamic range is blurred by halation or shadow.

HDR image

Dynamic range after HDR processing

Industry's highest dynamic range
Max. 16 times higher than previous models

Defects Detectable Even on Reflective or Shadowy Surfaces
The surface of the workpiece is accurately reproduced and detected even with overexposure or underexposure.

Shape Search III (Same functionality included in high-end sensors) Patent Pending

With Shape Search III, you can visualize comparisons between the registered model data the measurement object to easily see when comparisons are not optimally matched. Visualization of the comparison levels provide the guide for parameter adjustment for acceptable variation and distortion levels to quickly obtain the best performance. This can save you a lot of time and effort that were previously required.

Registered model

Measurement image

Chip

Deformation

You can see at a glance the difference between the registered model and measurement image.

Reduction in correlation

No reduction

You can adjust a parameter called the Acceptable Distortion Level to enable measurements without reducing the correlation even if there is distortion. You can easily adjust this parameter while monitoring the comparison.

New OCR Algorithm: Matching with Structural Models

Even in cases like the following one, where character registration is required for image matching methods, no character registration is required to read the characters with this new method, which matches structural models of characteristic points.

Structural models record the characteristics of each character in approximately 80 fonts.

The position and structure of characteristic points are used to recognize characters.





Background Changes



Size and Font Changes



Worn Characters

Inclined Characters

Lineup ranging from single-function models to full-function models

Inspection Model		FQ2-S1 Series	FQ2-S2 Series	FQ2-S3 Series High-resolution Type	
		Single-function Type	Standard Type	Integrated Sensor	C-mount
					
Number of pixels		350,000 pixels	350,000 pixels	760,000 pixels	1.3 million pixels
Color		Real color	Real color	Real color/Monochrome	Real color/Monochrome
Number of simultaneous measurements		1	32	32	32
Number of registered scenes		8	32	32	32
Inspection	Shape search III, Shape search II	•	•	•	•
	Search	•	•	•	•
	Sensitive search	•	•	•	•
	Edge position	•	•	•	•
	Edge width	•	•	•	•
	Edge pitch	•	•	•	•
	Area	•	•	•	•
	Color data	•	•	•	•
ID	Labeling	•	•	•	•
	Bar code	—	—	—	—
	2D code	—	—	—	—
	2D code (DPM)*	—	—	—	—
I/O specifications	OCR	—	—	—	—
	Communications (Ethernet TCP no-protocol, Ethernet UDP no-protocol, Ethernet FINS/TCP no-protocol, EtherNet/IP, PLC Link, or PROFINET)	•	•	•	•
	Sensor Data Units (I/O)	—	—	•	•
		—	—	•	•
		—	—	•	•

Inspection/ID Model		FQ2-S4 Series		
		Integrated Sensor	Integrated Sensor	C-mount
				
Number of pixels		350,000 pixels	760,000 pixels	1.3 million pixels
Color		Real color/Monochrome	Real color/Monochrome	Real color/Monochrome
Number of simultaneous measurements		32	32	32
Number of registered scenes		32	32	32
Inspection	Shape search III, Shape search II	•	•	•
	Search	•	•	•
	Sensitive search	•	•	•
	Edge position	•	•	•
	Edge width	•	•	•
	Edge pitch	•	•	•
	Area	•	•	•
	Color data	•	•	•
ID	Labeling	•	•	•
	Bar code	•	•	•
	2D code	•	•	•
	2D code (DPM)*	•	•	•
I/O specifications	OCR	•	•	•
	Communications (Ethernet TCP no-protocol, Ethernet UDP no-protocol, Ethernet FINS/TCP no-protocol, EtherNet/IP, PLC Link, or PROFINET)	•	•	•
	Sensor Data Units (I/O)	•	•	•
		•	•	•
		•	•	•

ID Model		FQ2-CH Series	FQ-CR1 Series	FQ-CR2 Series
		Optical Character Recognition Sensor	Multi Code Reader	2D Code Reader
				
Number of pixels		350,000 pixels	350,000 pixels	350,000 pixels
Color		Monochrome	Monochrome	Monochrome
Number of simultaneous measurements		32	32	32
Number of registered scenes		32	32	32
Inspection	Shape search II	—	—	—
	Search	—	—	—
	Sensitive search	—	—	—
	Edge position	—	—	—
	Edge width	—	—	—
	Edge pitch	—	—	—
	Area	—	—	—
ID	Color data	—	—	—
	Labeling	—	—	—
	Bar code	—	•	—
	2D code	—	•	—
I/O specifications	2D code (DPM)*	—	—	•
	OCR	•	—	—
	Communications (Ethernet TCP no-protocol)	•	•	•
	Communications (Ethernet UDP no-protocol, Ethernet FINS/TCP no-protocol, EtherNet/IP, PLC Link, or PROFINET)	•	—	—
	Sensor Data Units (I/O)	•	—	—
		•	—	—
		•	—	—

* Inspection item for directly marked 2D codes.

Sensor

Inspection Model

FQ2-S1 Series [Single-function Type]

Field of view	Narrow View	Standard View	Wide View (Long-distance)	Wide View (Short-distance)	
Number of pixels	350,000 pixels				
Color	NPN	FQ2-S10010F	FQ2-S10050F	FQ2-S10100F	FQ2-S10100N
	PNP	FQ2-S15010F	FQ2-S15050F	FQ2-S15100F	FQ2-S15100N
Field of view/ Installation distance	Refer to figure 1 on p.20	Refer to figure 2 on p.20	Refer to figure 3 on p.20	Refer to figure 4 on p.20	

FQ2-S2 Series [Standard Type]

Field of view	Narrow View	Standard View	Wide View (Long-distance)	Wide View (Short-distance)	
Number of pixels	350,000 pixels				
Color	NPN	FQ2-S20010F	FQ2-S20050F	FQ2-S20100F	FQ2-S20100N
	PNP	FQ2-S25010F	FQ2-S25050F	FQ2-S25100F	FQ2-S25100N
Field of view/ Installation distance	Refer to figure 1 on p.20	Refer to figure 2 on p.20	Refer to figure 3 on p.20	Refer to figure 4 on p.20	

FQ2-S3 Series [High-resolution Type]

Field of view	Narrow View	Standard View	Wide View (Long-distance)	Wide View (Short-distance)	C-mount	
Number of pixels	760,000 pixels				1.3 million pixels	
Color	NPN	FQ2-S30010F-08	FQ2-S30050F-08	FQ2-S30100F-08	FQ2-S30100N-08	FQ2-S30-13
	PNP	FQ2-S35010F-08	FQ2-S35050F-08	FQ2-S35100F-08	FQ2-S35100N-08	FQ2-S35-13
Monochrome	NPN	FQ2-S30010F-08M	FQ2-S30050F-08M	FQ2-S30100F-08M	FQ2-S30100N-08M	FQ2-S30-13M
	PNP	FQ2-S35010F-08M	FQ2-S35050F-08M	FQ2-S35100F-08M	FQ2-S35100N-08M	FQ2-S35-13M
Field of view/ Installation distance	Refer to figure 5 on p.20	Refer to figure 6 on p.20	Refer to figure 7 on p.20	Refer to figure 8 on p.20	Refer to optical chart on p.30.	

Inspection / ID Model

FQ2-S4 Series [Standard Type]

Field of view	Narrow View	Standard View	Wide View (Long-distance)	Wide View (Short-distance)	
Number of pixels	350,000 pixels				
Color	NPN	FQ2-S40010F	FQ2-S40050F	FQ2-S40100F	FQ2-S40100N
	PNP	FQ2-S45010F	FQ2-S45050F	FQ2-S45100F	FQ2-S45100N
Monochrome	NPN	FQ2-S40010F-M	FQ2-S40050F-M	FQ2-S40100F-M	FQ2-S40100N-M
	PNP	FQ2-S45010F-M	FQ2-S45050F-M	FQ2-S45100F-M	FQ2-S45100N-M
Field of view/ Installation distance	Refer to figure 1 on p.20	Refer to figure 2 on p.20	Refer to figure 3 on p.20	Refer to figure 4 on p.20	

[High-resolution Type]

Field of view	Narrow View	Standard View	Wide View (Long-distance)	Wide View (Short-distance)	C-mount	
Number of pixels	760,000 pixels				1.3 million pixels	
Color	NPN	FQ2-S40010F-08	FQ2-S40050F-08	FQ2-S40100F-08	FQ2-S40100N-08	FQ2-S40-13
	PNP	FQ2-S45010F-08	FQ2-S45050F-08	FQ2-S45100F-08	FQ2-S45100N-08	FQ2-S45-13
Monochrome	NPN	FQ2-S40010F-08M	FQ2-S40050F-08M	FQ2-S40100F-08M	FQ2-S40100N-08M	FQ2-S40-13M
	PNP	FQ2-S45010F-08M	FQ2-S45050F-08M	FQ2-S45100F-08M	FQ2-S45100N-08M	FQ2-S45-13M
Field of view/ Installation distance	Refer to figure 5 on p.20	Refer to figure 6 on p.20	Refer to figure 7 on p.20	Refer to figure 8 on p.20	Refer to optical chart on p.30.	

ID Model

FQ2-CH Series [Optical Character Recognition Sensor]

Field of view	Narrow View	Standard View	Wide View (Long-distance)	Wide View (Short-distance)	
Number of pixels	350,000 pixels				
Monochrome	NPN	FQ2-CH10010F-M	FQ2-CH10050F-M	FQ2-CH10100F-M	FQ2-CH10100N-M
	PNP	FQ2-CH15010F-M	FQ2-CH15050F-M	FQ2-CH15100F-M	FQ2-CH15100N-M
Field of view/ Installation distance	Refer to figure 1 on p.20	Refer to figure 2 on p.20	Refer to figure 3 on p.20	Refer to figure 4 on p.20	

FQ-CR1 Series [Multi Code Reader]





Field of view	Narrow View	Standard View	Wide View (Long-distance)	Wide View (Short-distance)	
Number of pixels	350,000 pixels				
Monochrome	NPN	FQ-CR10010F-M	FQ-CR10050F-M	FQ-CR10100F-M	FQ-CR10100N-M
	PNP	FQ-CR15010F-M	FQ-CR15050F-M	FQ-CR15100F-M	FQ-CR15100N-M
Field of view/ Installation distance	Refer to figure 1 on p.20	Refer to figure 2 on p.20	Refer to figure 3 on p.20	Refer to figure 4 on p.20	

FQ-CR2 Series [2D Code Reader]

Field of view	Narrow View	Standard View	Wide View (Long-distance)	Wide View (Short-distance)	
Number of pixels	350,000 pixels				
Monochrome	NPN	FQ-CR20010F-M	FQ-CR20050F-M	FQ-CR20100F-M	FQ-CR20100N-M
	PNP	FQ-CR25010F-M	FQ-CR25050F-M	FQ-CR25100F-M	FQ-CR25100N-M
Field of view/ Installation distance	Refer to figure 1 on p.20	Refer to figure 2 on p.20	Refer to figure 3 on p.20	Refer to figure 4 on p.20	

Field of view/Installation distance

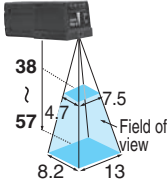
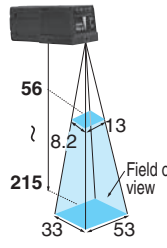
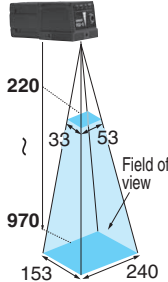
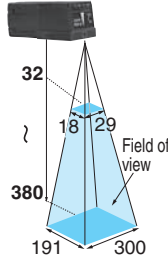
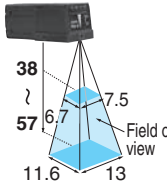
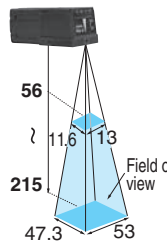
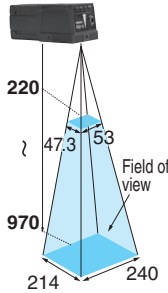
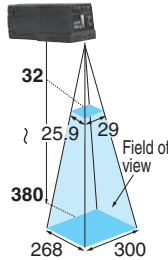

(Unit: mm)

Field of view	Narrow View	Standard View	Wide View (Long-distance)	Wide View (Short-distance)
Appearance				
350,000 pixels Type	<p>Figure 1</p>  <p>38 4.7 7.5 8.2 13 Field of view</p>	<p>Figure 2</p>  <p>56 8.2 13 215 33 53 Field of view</p>	<p>Figure 3</p>  <p>220 33 53 970 153 240 Field of view</p>	<p>Figure 4</p>  <p>32 18 29 380 191 300 Field of view</p>
760,000 pixels Type	<p>Figure 5</p>  <p>38 6.7 7.5 11.6 13 Field of view</p>	<p>Figure 6</p>  <p>56 11.6 13 215 47.3 53 Field of view</p>	<p>Figure 7</p>  <p>220 47.3 53 970 214 240 Field of view</p>	<p>Figure 8</p>  <p>32 25.9 29 380 268 300 Field of view</p>



Touch Finder

Type	Appearance	Model
DC power supply		FQ2-D30



Cables

Type	Appearance	Cable length	Model
FQ Ethernet Cables (connect Sensor to Touch Finder, Sensor to PC)		2m	FQ-WN002
		5m	FQ-WN005
		10m	FQ-WN010
		20m	FQ-WN020
I/O Cables		2m	FQ-WD002
		5m	FQ-WD005
		10m	FQ-WD010
		20m	FQ-WD020

Sensor Data Unit (FQ2-S3/S4/CH only)



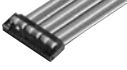







Type	Appearance	Output type	Model
Parallel Interface		NPN	FQ-SDU10
		PNP	FQ-SDU15
RS-232C Interface		NPN	FQ-SDU20
		PNP	FQ-SDU25

Cables for Sensor Data Unit

Type	Appearance	Cable length	Model
Sensor Data Unit Cable		2m	FQ-WU002
		5m	FQ-WU005
		10m	FQ-WU010
		20m	FQ-WU020
Parallel Cable for FQ-SDU1*		2m	FQ-VP1002
		5m	FQ-VP1005
		10m	FQ-VP1010
Parallel Cable for FQ-SDU2*		2m	FQ-VP2002
		5m	FQ-VP2005
		10m	FQ-VP2010
RS-232C Cable for FQ-SDU2		2m	XW2Z-200S-V
		5m	XW2Z-500S-V

* When using FQ-SDU□□, 2 Cables are required for all I/O signals.

Accessories

Application	Appearance	Name	Model
For Sensor		Mounting Bracket *1	FQ-XL
		Mounting Bracket for high-precision sensing *2	FQ-XL2
		Mounting Base for C-mount type *3	FQ-XLC
		Polarizing Filter Attachment *1	FQ-XF1
		Cover Attachment (for replacement)	FQ-XF2
For Touch Finder		Panel Mounting Adapter	FQ-XPM
		AC Adapter (for AC/DC/battery model) *4	FQ-A□
		Touch Pen *5	FQ-XT
		SD Card (2 GB)	HMC-SD291
		SD Card (4 GB)	HMC-SD492

Industrial Switching Hubs (Recommended)

Appearance	Number of ports	Current consumption	Model
	5	0.07 A	W4S1-05D

External Lighting

Type	Model
FLV Series	Refer to Vision Accessory Catalog (Q198)
FL Series	





- *1. Included with Integrated Sensor.
- *2. A mounting Bracket with improved resistance to vibrations and other external stresses that cause displacement of the optical axis and field of view.
- *3. Included with Sensor with C-mount.
- *4. AC Adapters for Touch Finder with DC / AC / Battery Power Supply. Select the model for the country in which the Touch Finder will be used.

Plug Type	Voltage	Certified standards	Model
A	125 V max.	PSE UL/CSA	FQ-AC1
	250 V max.	CCC mark	FQ-AC3
C	250 V max.	---	FQ-AC4

- *5. Enclosed with Touch Finder.

Lenses for C-mount Camera Refer to optical chart on p.30 for selection of a lens.

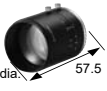
High-resolution, Low-distortion Lenses

Model	3Z4S-LE SV-0614H	3Z4S-LE SV-0814H	3Z4S-LE SV-1214H	3Z4S-LE SV-1614H	3Z4S-LE SV-2514H	3Z4S-LE SV-3514H	3Z4S-LE SV-5014H	3Z4S-LE SV-7525H	3Z4S-LE SV-10028H
Appearance/ Dimensions (mm)									
Focal length	6mm	8mm	12mm	16mm	25mm	35mm	50mm	75mm	100mm
Brightness	F1.4	F1.4	F1.4	F1.4	F1.4	F1.4	F1.4	F2.5	F2.8
Filter size	M40.5 P0.5	M35.5 P0.5	M27 P0.5	M27 P0.5	M27 P0.5	M35.5 P0.5	M40.5 P0.5	M34.0 P0.5	M37.5 P0.5

Extension Tubes

Model	3Z4S-LE SV-EXR
Contents	Set of 7 tubes (40 mm, 20 mm, 10 mm, 5 mm, 2.0 mm, 1.0 mm, and 0.5 mm) Maximum outer diameter: 30 mm dia.

- * Do not use the 0.5-mm, 1.0-mm, and 2.0-mm Extension Tubes attached to each other. Since these Extension Tubes are placed over the threaded section of the Lens or other Extension Tube, the connection may loosen when more than one 0.5-mm, 1.0- mm or 2.0-mm Extension Tube are used together.
- * Reinforcement is required to protect against vibration when Extension Tubes exceeding 30 mm are used.

System Configuration

Up to 32 Sensors can be set up and monitored from a single Touch Finder or Touch Finder for PC. Various types of Sensors can be used at the same time. However, I/O type and wiring method vary depending on the Sensor, so select the necessary devices.

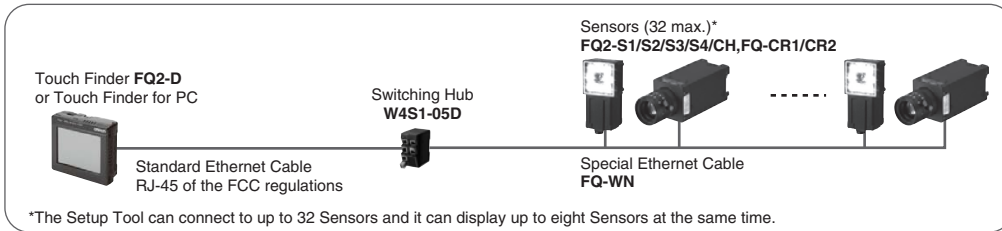

Note: Note: If you register as a member after purchasing a Sensor, you can download free setup software Touch Finder for PC that runs on a PC and can be used in place of Touch Finder. Refer to the member registration sheet for details.

Ethernet (EtherNet/IP, No-protocol, or PLC Link) Connection

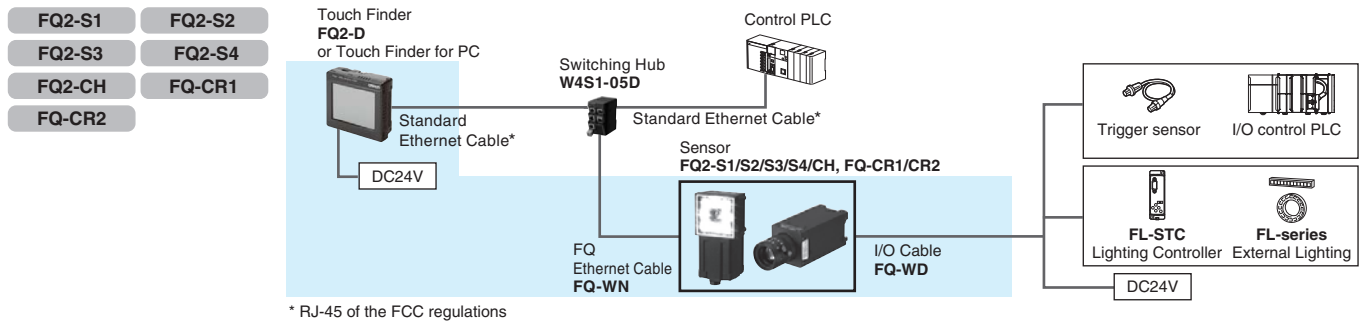

Parallel Interface Connection

Connection with Standard Parallel Interface of the Sensor

FQ2-S1	FQ2-S2
FQ2-S3	FQ2-S4
FQ2-CH	FQ-CR1
FQ-CR2	

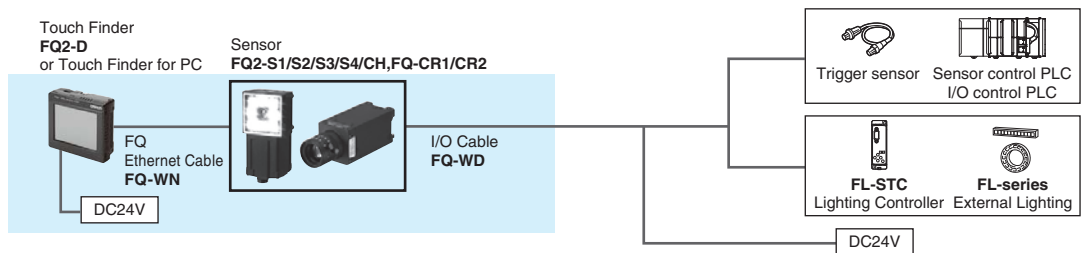

Connection through a Parallel Interface Sensor Data Unit

FQ2-S1	FQ2-S2
FQ2-S3	FQ2-S4
FQ2-CH	FQ-CR1
FQ-CR2	

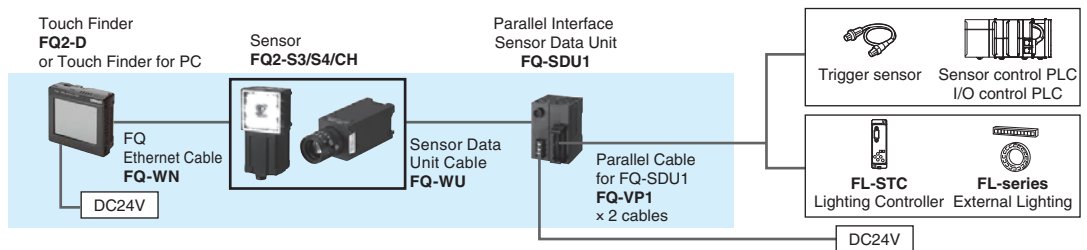

RS-232C Serial Connection

FQ2-S1	FQ2-S2
FQ2-S3	FQ2-S4
FQ2-CH	FQ-CR1
FQ-CR2	

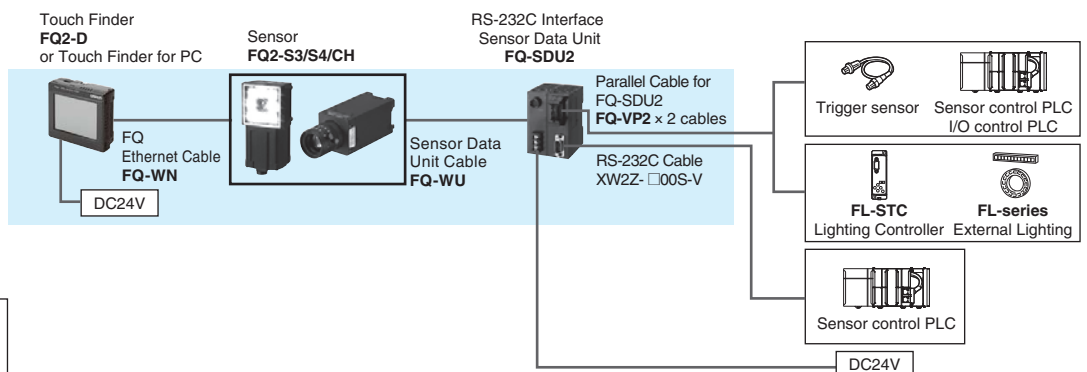

Model compatible with communications interface

<input checked="" type="checkbox"/>	Compatible
<input type="checkbox"/>	Not compatible

Sensor [Inspection Model FQ2-S1/S2/S3 Series]

Item		Single-function type	Standard type	High-resolution type			
Model	NPN	FQ2-S10□□□□	FQ2-S20□□□□	FQ2-S30□□□□-08	FQ2-S30□□□□-08M	FQ2-S30-13	FQ2-S30-13M
	PNP	FQ2-S15□□□□	FQ2-S25□□□□	FQ2-S35□□□□-08	FQ2-S35□□□□-08M	FQ2-S35-13	FQ2-S35-13M
Field of view		Refer to Ordering Information on p.19. (Tolerance (field of view): ±10% max.)				Select a lens according to the field of view and installation distance.	
Installation distance						Refer to the optical chart on p.30.	
Main functions	Inspection items	Shape Search III, Shape Search II, Search, sensitive search, area, color data, edge position, edge pitch, edge width, and labeling					
	Number of simultaneous measurements	1	32				
	Position compensation	Supported (360° Model position compensation, Edge position compensation, Linear correction)					
	Number of registered scenes	8 *	32 *				
	Calibration	Supported					
Image input	Image processing method	Real color		Monochrome	Real color	Monochrome	
	Image filter	High dynamic range (HDR), image adjustment (Color Gray Filter, Weak smoothing, Strong smoothing, Dilate, Erosion, Median, Extract edges, Extract horizontal edges, Extract vertical edges, Enhance edges, Background suppression), polarizing filter (attachment), and white balance (Sensors with Color Cameras only), Brightness Correction					
	Image elements	1/3-inch color CMOS		1/2-inch color CMOS	1/2-inch Monochrome CMOS	1/2-inch color CMOS	1/2-inch Monochrome CMOS
	Shutter	Built-in lighting ON: 1/250 to 1/50,000s Built-in lighting OFF: 1/1 to 1/50,000s		Built-in lighting ON: 1/250 to 1/60,000s Built-in lighting OFF: 1/1 to 1/4155s		1/1 to 1/4155s	
	Processing resolution	752 × 480		928 × 828		1280 × 1024	
	Partial input function	Supported horizontally only.		Supported horizontally and vertically			
	Image display	Zoom-in/Zoom-out/Fit, Rotating by 180°					
	Lens mounts	---				C-mount	
Lighting	Lighting method	Pulse				---	
	Lighting color	White				---	
Data logging	Measurement data	In Sensor: 1,000 items (If a Touch Finder is used, results can be saved up to the capacity of an SD card.)					
	Images	In Sensor: 20 images (If a Touch Finder is used, images can be saved up to the capacity of an SD card.)					
Auxiliary function		Statistical data, Test Measurements, I/O monitor, Password function, Simulation software, Sensor error history, Calibration, Math (arithmetic, calculation functions, trigonometric functions, and logic functions)					
Measurement trigger		External trigger (single or continuous) Communications trigger (Ethernet TCP no-protocol, Ethernet UDP no-protocol, Ethernet FINS/TCP no-protocol, EtherNet/IP, PLC Link , or PROFINET)					
I/O specifications	Input signals	7 signals • Single measurement input (TRIG) • Control command input (IN0 to IN5)					
	Output signals	3 signals • Control output (BUSY) • Overall judgement output (OR) • Error output (ERROR) Note: The assignments of the three output signals (OUT0 to OUT2) can also be changed to the following: • READY • RUN • STG (Strobe trigger) • OR0 (Item0 judgement) to OR31 (Item31 judgement) • Exp.0 judgement to Exp.31 judgement					
	Ethernet specifications	100Base-TX/10Base-T					
	Communications	Ethernet TCP no-protocol, Ethernet UDP no-protocol, Ethernet FINS/TCP no-protocol, EtherNet/IP, PLC Link , or PROFINET					
	I/O expansion	---	---	Possible by connecting FQ-SDU1_ Sensor Data Unit. 11 inputs and 24 outputs			
	RS-232C	---	---	Possible by connecting FQ-SDU2_ Sensor Data Unit. 8 inputs and 7 outputs			
	Ratings	Power supply voltage	21.6 to 26.4 VDC (including ripple)				
Current consumption		2.4 A max.				0.3 A max.	
Environmental immunity	Ambient temperature range	Operating: 0 to 50°C Storage: -25 to 65°C (with no icing or condensation)		Operating: 0 to 40°C Storage: -25 to 65°C (with no icing or condensation)			
	Ambient humidity range	Operating and storage: 35% to 85% (with no condensation)					
	Ambient atmosphere	No corrosive gas					
	Vibration resistance (destruction)	10 to 150 Hz, single amplitude: 0.35 mm, X/Y/Z directions 8 min each, 10 times					
	Shock resistance (destruction)	150 m/s ² 3 times each in 6 direction (up, down, right, left, forward, and backward)					
	Degree of protection	IEC 60529 IP67 (Except when Polarizing Filter Attachment is mounted or connector cap is removed.)				IEC 60529 IP40	
Materials	Sensor: PBT, PC, SUS Mounting Bracket: PBT Polarizing Filter Attachment: PBT, PC Ethernet connector: Oil-resistance vinyl compound I/O connector: Lead-free heat-resistant PVC				Cover: Zinc-plated steel, Thickness: 0.6 mm Case: Aluminum diecast alloy (ADC-12) Mounting base: Polycarbonate ABS		
Weight	Narrow View/Standard View: Approx. 160 g Wide View: Approx. 150 g				Approx. 160 g without base, Approx. 185 g with base		
Accessories included with sensor	Mounting Bracket (FQ-XL) (1) Polarizing Filter Attachment (FQ-XF1) (1) Instruction Manual , Member Registration Sheet				Mounting Base (FQ-XLC) (1) Mounting Screw (M3 × 8mm) (4) Instruction Manual, Member Registration Sheet		
LED class	Risk Group 2 (IEC62471)						

* The maximum number of registerable scenes depends on settings due to restrictions on memory.

Sensor [Inspection/ID Model FQ2-S4 Series]

Item		Inspection/ID Model						
Model	NPN	FQ2-S40□□□□	FQ2-S40□□□□-M	FQ2-S40□□□□-08	FQ2-S40□□□□-08M	FQ2-S40□□□□-13	FQ2-S40□□□□-13M	
	PNP	FQ2-S45□□□□	FQ2-S45□□□□-M	FQ2-S45□□□□-08	FQ2-S45□□□□-08M	FQ2-S45□□□□-13	FQ2-S45□□□□-13M	
Field of view		Refer to Ordering Information on p.19. (Tolerance (field of view): ±10% max.)					Select a lens according to the field of view and installation distance. Refer to the optical chart on p.30.	
Installation distance		Refer to Ordering Information on p.19. (Tolerance (field of view): ±10% max.)						
Main functions	Inspection items	Shape Search III, Shape Search II, Search, Sensitive Search, Area, Color Data, Edge Position, Edge Pitch, Edge Width, Labeling, OCR *1, Bar code *2, 2D-code *2, 2D-code (DMP) *3, and Model Dictionary						
	Number of simultaneous measurements	32						
	Position compensation	Supported (360° Model position compensation, Edge position compensation, Linear correction)						
	Number of registered scenes	32 *4						
	Calibration	Supported						
	Retry function	Normal retry, Exposure retry, Scene retry, Trigger retry						
Print Quality Grading Function	Applicable standards: ISO/IEC TR 29158 (AIM DPM-1-2006) (Applicable code: Data Matrix ECC200)							
Image input	Image processing method	Real color	Monochrome	Real color	Monochrome	Real color	Monochrome	
	Image filter	High dynamic range (HDR), image adjustment (Color Gray Filter, Weak smoothing, Strong smoothing, Dilate, Erosion, Median, Extract edges, Extract horizontal edges, Extract vertical edges, Enhance edges, Background suppression), polarizing filter (attachment), and white balance (Sensors with Color Cameras only), Brightness Correction						
	Image elements	1/3-inch color CMOS	1/3-inch Monochrome CMOS	1/2-inch color CMOS	1/2-inch Monochrome CMOS	1/2-inch color CMOS	1/2-inch Monochrome CMOS	
	Shutter	Built-in lighting ON: 1/250 to 1/50,000s Built-in lighting OFF: 1/1 to 1/50,000s		Built-in lighting ON: 1/250 to 1/60,000s Built-in lighting OFF: 1/1 to 1/4155s		1/1 to 1/4155s		
	Processing resolution	752 × 480		928 × 828		1280 × 1024		
	Partial input function	Supported horizontally only.		Supported horizontally and vertically				
	Image display	Zoom-in/Zoom-out/Fit, Rotating by 180°						
	Lens mounts	---					C-mount	
Lighting	Lighting method	Pulse					---	
	Lighting color	White					---	
Data logging	Measurement data	In Sensor: 1,000 items (If a Touch Finder is used, results can be saved up to the capacity of an SD card.)						
	Images	In Sensor: 20 images (If a Touch Finder is used, images can be saved up to the capacity of an SD card.)						
Auxiliary function		Statistical data, Test Measurements, I/O monitor, Password function, Simulation software, Sensor error history, Calibration, Math (arithmetic, calculation functions, trigonometric functions, and logic functions)						
Measurement trigger		External trigger (single or continuous) Communications trigger (Ethernet TCP no-protocol, Ethernet UDP no-protocol, Ethernet FINS/TCP no-protocol, EtherNet/IP, PLC Link, or PROFINET)						
I/O specifications	Input signals	7 signals • Single measurement input (TRIG) • Control command input (IN0 to IN5)						
	Output signals	3 signals • Control output (BUSY) • Overall judgement output (OR) • Error output (ERROR) Note: The assignments of the three output signals (OUT0 to OUT2) can also be changed to the following: • READY • RUN • STG (Strobe trigger) • OR0 (Item0 judgement) to OR31 (Item31 judgement) • Exp.0 judgement to Exp.31 judgement						
	Ethernet specifications	100Base-TX/10Base-T						
	Communications	Ethernet TCP no-protocol, Ethernet UDP no-protocol, Ethernet FINS/TCP no-protocol, EtherNet/IP, PLC Link, or PROFINET						
	I/O expansion	Possible by connecting FQ-SDU1_ Sensor Data Unit. 11 inputs and 24 outputs						
	RS-232C	Possible by connecting FQ-SDU2_ Sensor Data Unit. 8 inputs and 7 outputs						
	Power supply voltage	21.6 to 26.4 VDC (including ripple)						
Ratings	Current consumption	2.4 A max.				0.3 A max.		
	Ambient temperature range	Operating: 0 to 40°C Storage: -25 to 65°C (with no icing or condensation)						
Environmental immunity	Ambient humidity range	Operating and storage: 35% to 85% (with no condensation)						
	Ambient atmosphere	No corrosive gas						
	Vibration resistance (destruction)	10 to 150 Hz, single amplitude: 0.35 mm, X/Y/Z directions 8 min each, 10 times						
	Shock resistance (destruction)	150 m/s ² 3 times each in 6 direction (up, down, right, left, forward, and backward)						
	Degree of protection	IEC 60529 IP67 (Except when Polarizing Filter Attachment is mounted or connector cap is removed.)				IEC 60529 IP40		
Materials	Sensor: PBT, PC, SUS Mounting Bracket: PBT Polarizing Filter Attachment: PBT, PC Ethernet connector: Oil-resistance vinyl compound I/O connector: Lead-free heat-resistant PVC					Cover: Zinc-plated steel, Thickness: 0.6 mm Case: Aluminum diecast alloy (ADC-12) Mounting base: Polycarbonate ABS		
Weight	Narrow View/Standard View: Approx. 160 g Wide View: Approx. 150 g					Approx. 160 g without base, Approx. 185 g with base		
Accessories included with sensor	Mounting Bracket (FQ-XL) (1) Polarizing Filter Attachment (FQ-XF1) (1) Instruction Manual, Member Registration Sheet					Mounting Base (FQ-XLC) (1) Mounting Screw (M3 × 8mm) (4) Instruction Manual, Member Registration Sheet		
LED class	Risk Group 2 (IEC62471)							

*1. The types of characters to be read are the same as those of FQ2-CH Optical Character Recognition Sensor (p.25).

*2. The types of cedes to be read are the same as those of FQ-CR1 Multi Code Reader (p.25).

*3. The types of cedes to be read are the same as those of FQ-CR2 2D Code Reader (p.25).

*4. The maximum number of registerable scenes depends on settings due to restrictions on memory.

Sensor [ID Model FQ2-CH, FQ-CR1/CR2 Series]

Item		Optical Character Recognition Sensor	Multi Code Reader	2D Code Reader
Model	NPN	FQ2-CH10□□□□-M	FQ-CR10□□□□-M	FQ-CR20□□□□-M
	PNP	FQ2-CH15□□□□-M	FQ-CR15□□□□-M	FQ-CR25□□□□-M
Field of view		Refer to Ordering Information on p.19. (Tolerance (field of view): ±10% max.)		
Installation distance				
Main functions	Inspection items	OCR · Alphabet A to Z · Number 0 to 9 · Symbol ' - . : / Model dictionary	2D Code (Data Matrix (ECC200), QR Code, MicroQR Code, PDF417, MicroPDF417, GS1-DataMatrix) Bar Code (JAN/EAN/UPC, Code39, Codabar (NW-7), ITF (Interleaved 2 of 5), Code 93, Code128/GS1-128, GS1 DataBar* (Truncated, Stacked, Omni-directional, Stacked, Omnidirectional, Limited, Expanded, Expanded Stacked), Pharmacode, GS1-128 Composite Code (CC-A, CC-B, CC-C))	2D Code (Data Matrix (ECC200), QR Code)
	Image filter	Weak smoothing, Strong smoothing, Dilate, Erosion, Median, Extract edges, Extract horizontal edges, Extract vertical edges, Enhance edges, Background suppression	None	Filter function (Smooth, Dilate, Erosion, Median), Code Error Correction Position Display
	Verification function	Supported	Supported	None
	Retry function	Normal retry, Exposure retry, Scene retry, Trigger retry	None	Normal retry, Exposure retry, Scene retry, Trigger retry
	Number of simultaneous measurements	32		
	Position compensation	Supported (360° Model position compensation, Edge position compensation, Linear correction)		None
	Number of registered scenes	32		
Image input	Image processing method	Monochrome		
	Image filter	High dynamic range (HDR), polarizing filter (attachment), Brightness Correction	High dynamic range (HDR), polarizing filter (attachment)	
	Image elements	1/3-inch Monochrome CMOS		
	Shutter	Built-in lighting ON: 1/250 to 1/50,000s Built-in lighting OFF: 1/1 to 1/50,000s	1/250 to 1/30,000s	1/250 to 1/32,258s
	Processing resolution	752 × 480		
	Partial input function	Supported horizontally only.		
Lighting	Image display	Zoom-in/Zoom-out/Fit, Rotating by 180°	Zoom-in/Zoom-out/Fit	
	Lighting method	Pulse		
Data logging	Lighting color	White		
	Measurement data	In Sensor: 1,000 items (If a Touch Finder is used, results can be saved up to the capacity of an SD card.)		
Auxiliary function	Images	In Sensor: 20 images (If a Touch Finder is used, images can be saved up to the capacity of an SD card.)		
	Math function	Arithmetic, calculation functions, trigonometric functions, and logic functions		---
Measurement trigger	Auxiliary function	Statistical data, Test Measurements, I/O monitor, Password function, Simulation software, Sensor error history, Calibration		
	Math function	Arithmetic, calculation functions, trigonometric functions, and logic functions		---
I/O specifications	Measurement trigger	External trigger (single or continuous) Communications trigger (Ethernet TCP no-protocol, Ethernet UDP no-protocol, Ethernet FINS/TCP no-protocol, EtherNet/IP, PLC Link, or PROFINET)	External trigger (single or continuous) Communications trigger (Ethernet TCP no-protocol)	
	Input signals	7 signals • Single measurement input (TRIG) • Control command input (IN0 to IN5)		
	Output signals	3 signals • Control output (BUSY) • Overall judgement output (OR) • Error output (ERROR) Note: The assignments of the three output signals (OUT0 to OUT2) can also be changed to the following: • READY • RUN • STG (Strobe trigger) • OR0 (Item0 judgement) to OR31 (Item31 judgement) • Exp.0 judgement to Exp.31 judgement	3 signals • Control output (BUSY) • Overall judgement output (OR) • Error output (ERROR) Note: Note: The three output signals can be allocated for the judgements of individual inspection items.	
	Ethernet specifications	100Base-TX/10Base-T		
	Communications	Ethernet TCP no-protocol, Ethernet UDP no-protocol, Ethernet FINS/TCP no-protocol, EtherNet/IP, PLC Link, or PROFINET	Ethernet TCP no-protocol	
	I/O expansion	Possible by connecting FQ-SDU1_Sensor Data Unit. 11 inputs and 24 outputs		
Ratings	RS-232C	Possible by connecting FQ-SDU2_Sensor Data Unit. 8 inputs and 7 outputs		
	Power supply voltage	21.6 to 26.4 VDC (including ripple)		
Environmental immunity	Current consumption	2.4 A max.		
	Ambient temperature range	Operating: 0 to 40°C, Storage: -25 to 65°C (with no icing or condensation)	Operating: 0 to 50°C, Storage: -25 to 65°C (with no icing or condensation)	
	Ambient humidity range	Operating and storage: 35% to 85% (with no condensation)		
	Ambient atmosphere	No corrosive gas		
	Vibration resistance (destruction)	10 to 150 Hz, single amplitude: 0.35 mm, X/Y/Z directions 8 min each, 10 times		
Materials	Shock resistance (destruction)	150 m/s ² 3 times each in 6 direction (up, down, right, left, forward, and backward)		
	Degree of protection	IEC 60529 IP67 (Except when Polarizing Filter Attachment is mounted or connector cap is removed.)		
Weight	Sensor: PBT, PC, SUS, Mounting Bracket: PBT, Polarizing Filter Attachment: PBT, PC Ethernet connector: Oil-resistance vinyl compound, I/O connector: Lead-free heat-resistant PVC			
Accessories included with sensor	Narrow View/Standard View: Approx. 160 g Wide View: Approx. 150 g Mounting Bracket (FQ-XL) (1), Polarizing Filter Attachment (FQ-XF1) (1), Instruction Manual, Member Registration Sheet			
LED class	Risk Group 2 (IEC62471)			

Touch Finder

Item	Model	Type	Model with DC power supply
			FQ2-D30
Number of connectable Sensor		Number of sensors that can be recognized (switched): 32 max. number of sensor that can be displayed on monitor: 8 max.	
Main functions	Types of measurement displays		Last result display, Last NG display, trend monitor, histograms
	Types of display images		Through, frozen, zoom-in, and zoom-out images
	Data logging		Measurement results, measured images
	Menu language		English, German, French, Italian, Spanish, Traditional Chinese, Simplified Chinese, Korean, Japanese
Indications	LCD	Display device	3.5-inch TFT color LCD
		Pixels	320 × 240
		Display colors	16.7 million
	Backlight	Life expectancy *1	50,000 hours at 25°C
		Brightness adjustment	Provided
Screen saver	Provided		
Operation interface	Touch screen	Method	Resistance film
		Life expectancy *2	1,000,000 touch operations
External interface	Ethernet		100BASE-TX/10BASE-T
	SD card		SDHC-compliant, Class 4 or higher recommended
Ratings	Power supply voltage		DC power connection: 21.6 to 26.4 VDC (including ripple)
	Continuous operation on Battery *3		---
	Power consumption		DC power connection: 0.2 A max.
Environmental immunity	Ambient temperature range		Operating: 0 to 50°C Storage: -25 to 65°C (with no icing or condensation)
	Ambient humidity range		Operating and storage: 35% to 85% (with no condensation)
	Ambient atmosphere		No corrosive gas
	Vibration resistance (destruction)		10 to 150 Hz, single amplitude: 0.35 mm, X/Y/Z directions 8 min each, 10 times
	Shock resistance (destruction)		150 m/s ² 3 times each in 6 direction (up, down, right, left, forward, and backward)
	Degree of protection		IEC 60529 IP20 (when SD card cover, connector cap, or harness is attached)
Weight		Approx. 270 g (without Battery and hand strap attached)	
Materials		Case: ABS	
Accessories included with Touch Finder		Touch Pen (FQ-XT), Instruction Manual	

*1. This is a guideline for the time required for the brightness to diminish to half the initial brightness at room temperature and humidity. The life of the backlight is greatly affected by the ambient temperature and humidity and will be shorter at lower or higher temperatures.

*2. This value is only a guideline. No guarantee is implied. The value will be affected by operating conditions.

*3. This value is only a guideline. No guarantee is implied. The value will be affected by the operating environment and operating conditions.

Sensor Data Units (FQ2-S3/S4/CH only)

Item	Parallel Interface		RS-232C Interface
	NPN	FQ-SDU10	FQ-SDU20
Model	PNP		FQ-SDU15
			FQ-SDU25
I/O specifications	Parallel I/O	Connector 1	16 outputs (D0 to D15)
		Connector 2	11 inputs (TRIG, RESET, IN0 to IN7, and DSA) 8 outputs (GATE, ACK, RUN, BUSY, OR, ERROR, STGOUT, and SHTOUT)
	RS-232C		---
	Sensor interface		FQ2-S3 connected with FQ-WU□□□□ : OMRON interface *Number of connected Sensors: 1
Ratings	Power supply voltage		21.6 to 26.4 VDC (including ripple)
	Insulation resistance		Between all DC external terminals and case: 0.5 MΩ min (at 250 VDC)
	Current consumption		2.5 A max. : FQ2-S□□□□□□□□□□ and FQ-SDU□□□, FQ2-CH1□□□□□□□□-M and FQ-SDU□□□ 0.4 A max. : FQ2-S□□□□□□□□□□ and FQ-SDU□□□ 0.1 A max. : FQ-SDU□□□□ only
Environmental immunity	Ambient temperature range		Operating: 0 to 50°C, Storage: -20 to 65°C (with no icing or condensation)
	Ambient humidity range		Operating and storage: 35% to 85% (with no condensation)
	Ambient atmosphere		No corrosive gas
	Vibration resistance (destruction)		10 to 150 Hz, single amplitude: 0.35 mm, X/Y/Z directions, 8 min each, 10 times
	Shock resistance (destruction)		150 m/s ² 3 times each in 6 directions (up, down, right, left, forward, and backward)
Degree of protection		IEC 60529 IP20	
Materials		Case: PC + ABS, PC	
Weight		Approx. 150 g	
Accessories included with Sensor Data Unit		Instruction Manual	

System Requirements for Touch Finder for PC

The following Personal Computer system is required to use the software.

OS	Microsoft Windows 7 Home Premium or higher (32-bit/64-bit version) Microsoft Windows 8.1 Pro Edition or higher (32-bit/64-bit version) Microsoft Windows 10 Home Edition or higher (32-bit/64-bit version)
CPU	Core 2 Duo 1.06 GHz or the equivalent or higher
RAM	1GB min.
HDD	500 MB min. available space *
Monitor	1,024 × 768 dots min.

*. Available space is also required separately for data logging.

Sensor

Integrated Sensor

Narrow View

FQ2-S□□□10F-□□□

FQ2-CH□□□10F-M

FQ-CR□□□10F-M

Standard View

FQ2-S□□□50F-□□□

FQ2-CH□□□50F-M

FQ-CR□□□50F-M

Wide View

FQ2-S□□□100□-□□□

FQ2-CH□□□100□-M

FQ-CR□□□100□-M

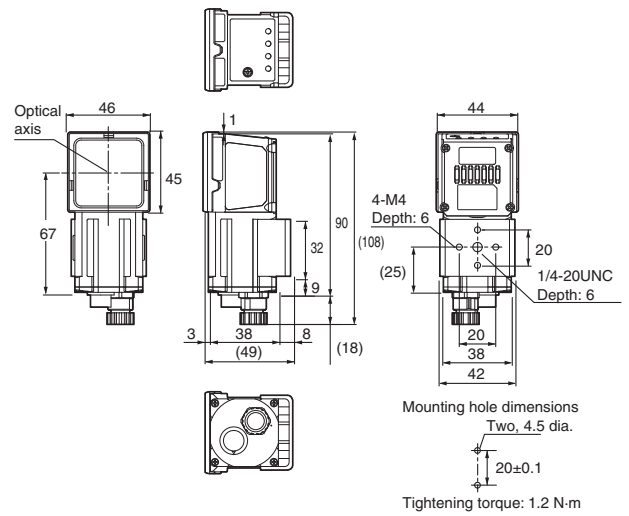
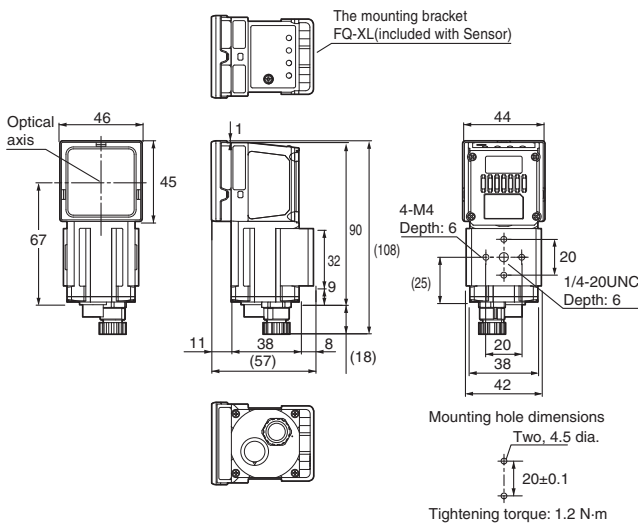

C-mount

FQ2-S3□-13□

FQ2-S4□-13□

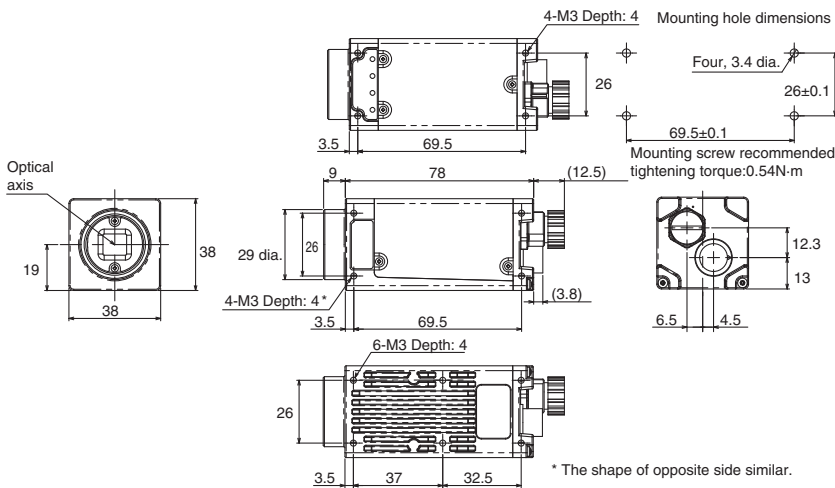

Mounting Base FQ-XLC (included with Sensor)

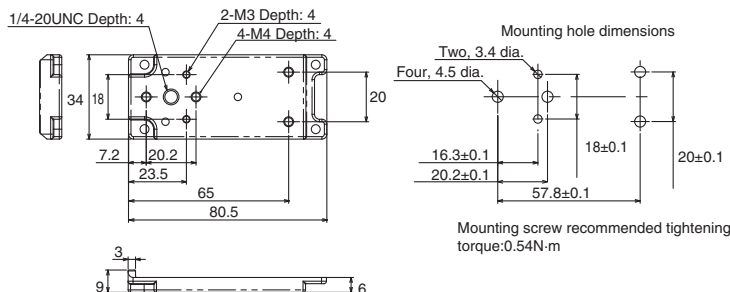

(Unit: mm)

Touch Finder

FQ2-D30

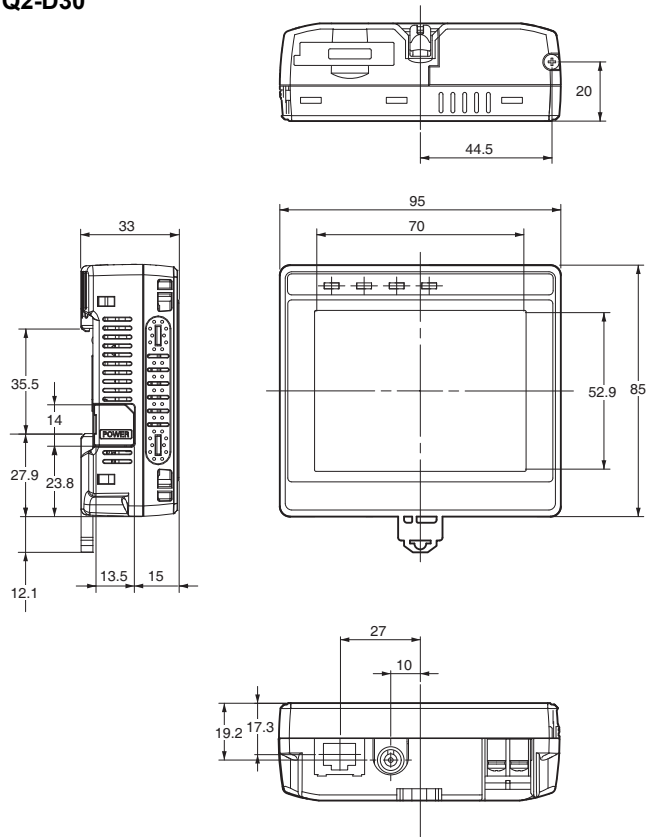

Panel Mounting Adapter FQ-XPM

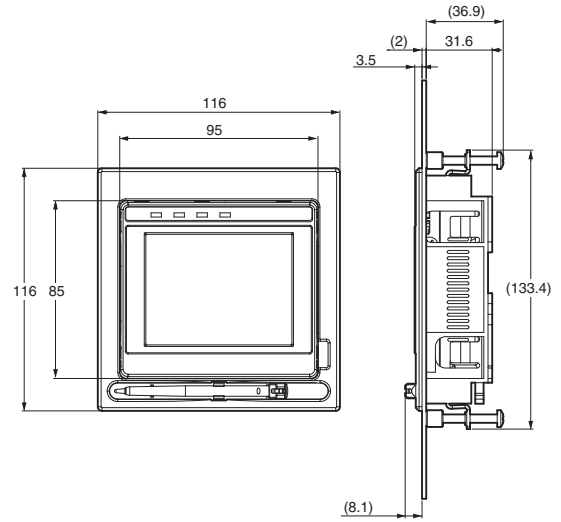

Panel Cutout Dimensions

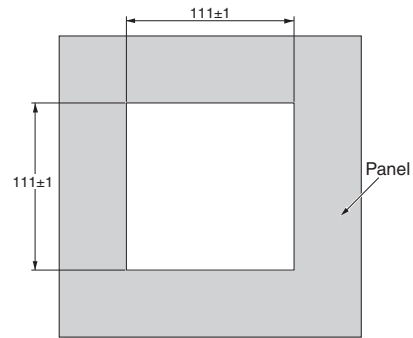

Sensor Data Unit

FQ-SDU10/-SDU15

FQ-SDU20/-SDU25

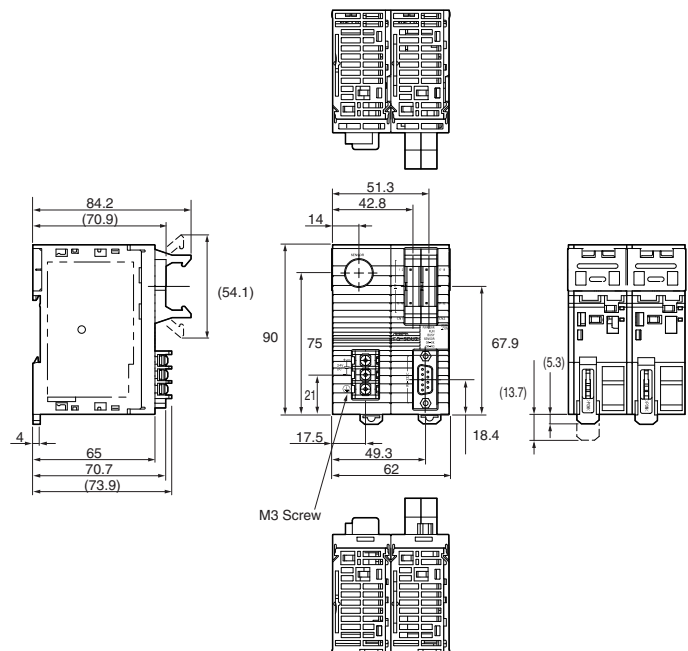
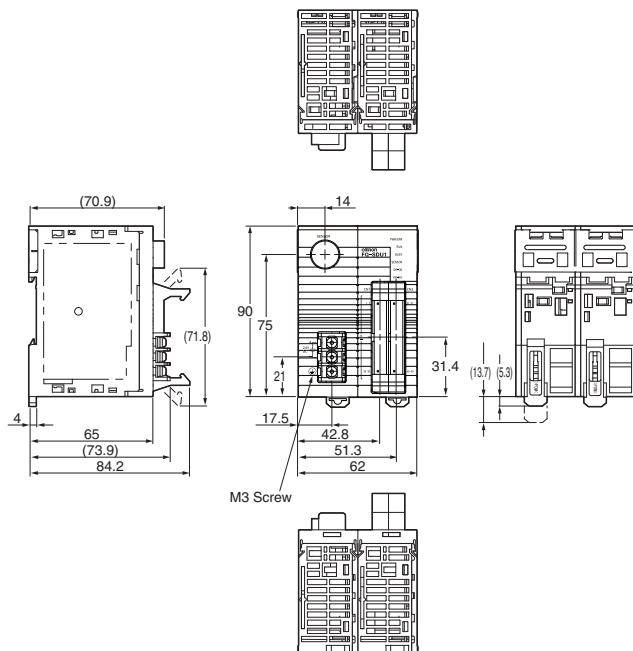

Optical Chart for C-mount Camera FQ2-S3□-13□/-S4□-13□

High-resolution, Low-distortion Lenses 3Z4S-LE SV-□□□□H

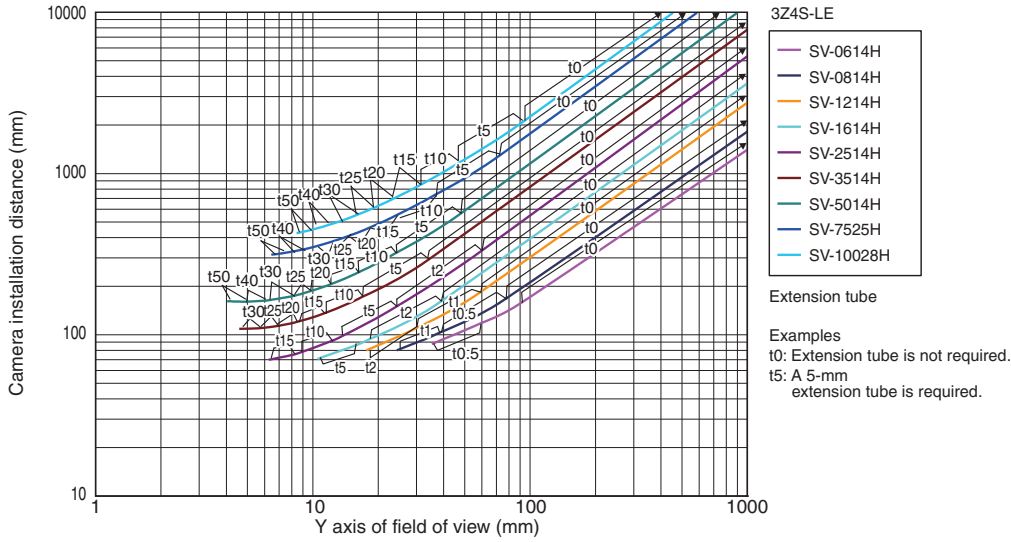

Meaning of Optical Chart

The X axis of the optical chart shows the field of view (mm) (See Note.), and the Y axis of the optical chart shows the camera installation distance (mm).

Note: The lengths of the fields of view given in the optical charts are the lengths of the Y axis.

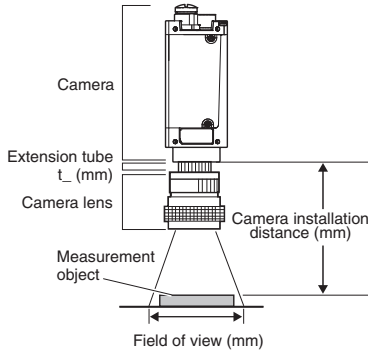

Related Manuals

Man.No.	Model number	Manual
Z337	FQ2-S1/S2/S3/S4/CH	Smart Camera FQ2-S/CH Series User's manual
Z338	FQ2-S1/S2/S3/S4/CH	Smart Camera FQ2-S/CH Series User's manual (Communication Settings)
Z329	FQ-CR1-M	Fixed Mount Multi Code Reader FQ-CR1-M User's manual
Z316	FQ-CR2	Fixed Mount 2D Code Reader FQ-CR2 User's manual

READ AND UNDERSTAND THIS CATALOG

Please read and understand this catalog before purchasing the products. Please consult your OMRON representative if you have any questions or comments.

WARRANTY

OMRON's exclusive warranty is that the products are free from defects in materials and workmanship for a period of one year (or other period if specified) from date of sale by OMRON.

OMRON MAKES NO WARRANTY OR REPRESENTATION, EXPRESS OR IMPLIED, REGARDING NON-INFRINGEMENT, MERCHANTABILITY, OR FITNESS FOR PARTICULAR PURPOSE OF THE PRODUCTS. ANY BUYER OR USER ACKNOWLEDGES THAT THE BUYER OR USER ALONE HAS DETERMINED THAT THE PRODUCTS WILL SUITABLY MEET THE REQUIREMENTS OF THEIR INTENDED USE. OMRON DISCLAIMS ALL OTHER WARRANTIES, EXPRESS OR IMPLIED.

LIMITATIONS OF LIABILITY

OMRON SHALL NOT BE RESPONSIBLE FOR SPECIAL, INDIRECT, OR CONSEQUENTIAL DAMAGES, LOSS OF PROFITS OR COMMERCIAL LOSS IN ANY WAY CONNECTED WITH THE PRODUCTS, WHETHER SUCH CLAIM IS BASED ON CONTRACT, WARRANTY, NEGLIGENCE, OR STRICT LIABILITY.

In no event shall responsibility of OMRON for any act exceed the individual price of the product on which liability is asserted.

IN NO EVENT SHALL OMRON BE RESPONSIBLE FOR WARRANTY, REPAIR, OR OTHER CLAIMS REGARDING THE PRODUCTS UNLESS OMRON'S ANALYSIS CONFIRMS THAT THE PRODUCTS WERE PROPERLY HANDLED, STORED, INSTALLED, AND MAINTAINED AND NOT SUBJECT TO CONTAMINATION, ABUSE, MISUSE, OR INAPPROPRIATE MODIFICATION OR REPAIR.

SUITABILITY FOR USE

THE PRODUCTS CONTAINED IN THIS CATALOG ARE NOT SAFETY RATED. THEY ARE NOT DESIGNED OR RATED FOR ENSURING SAFETY OF PERSONS, AND SHOULD NOT BE RELIED UPON AS A SAFETY COMPONENT OR PROTECTIVE DEVICE FOR SUCH PURPOSES. Please refer to separate catalogs for OMRON's safety rated products.

OMRON shall not be responsible for conformity with any standards, codes, or regulations that apply to the combination of products in the customer's application or use of the product.

At the customer's request, OMRON will provide applicable third party certification documents identifying ratings and limitations of use that apply to the products. This information by itself is not sufficient for a complete determination of the suitability of the products in combination with the end product, machine, system, or other application or use.

The following are some examples of applications for which particular attention must be given. This is not intended to be an exhaustive list of all possible uses of the products, nor is it intended to imply that the uses listed may be suitable for the products:

- Outdoor use, uses involving potential chemical contamination or electrical interference, or conditions or uses not described in this document.
- Nuclear energy control systems, combustion systems, railroad systems, aviation systems, medical equipment, amusement machines, vehicles, safety equipment, and installations subject to separate industry or government regulations.
- Systems, machines, and equipment that could present a risk to life or property.

Please know and observe all prohibitions of use applicable to the products.

NEVER USE THE PRODUCTS FOR AN APPLICATION INVOLVING SERIOUS RISK TO LIFE OR PROPERTY WITHOUT ENSURING THAT THE SYSTEM AS A WHOLE HAS BEEN DESIGNED TO ADDRESS THE RISKS, AND THAT THE OMRON PRODUCT IS PROPERLY RATED AND INSTALLED FOR THE INTENDED USE WITHIN THE OVERALL EQUIPMENT OR SYSTEM.

PERFORMANCE DATA

Performance data given in this document is provided as a guide for the user in determining suitability and does not constitute a warranty. It may represent the result of OMRON's test conditions, and the users must correlate it to actual application requirements. Actual performance is subject to the OMRON Warranty and Limitations of Liability.

CHANGE IN SPECIFICATIONS

Product specifications and accessories may be changed at any time based on improvements and other reasons.

It is our practice to change model numbers when published ratings or features are changed, or when significant construction changes are made. However, some specifications of the product may be changed without any notice. When in doubt, special model numbers may be assigned to fix or establish key specifications for your application on your request. Please consult with your OMRON representative at any time to confirm actual specifications of purchased products.

DIMENSIONS AND WEIGHTS

Dimensions and weights are nominal and are not to be used for manufacturing purposes, even when tolerances are shown.

ERRORS AND OMISSIONS

The information in this document has been carefully checked and is believed to be accurate; however, no responsibility is assumed for clerical, typographical, or proofreading errors, or omissions.

PROGRAMMABLE PRODUCTS

OMRON shall not be responsible for the user's programming of a programmable product, or any consequence thereof.

COPYRIGHT AND COPY PERMISSION

This document shall not be copied for sales or promotions without permission.

This document is protected by copyright and is intended solely for use in conjunction with the product. Please notify us before copying or reproducing this document in any manner, for any other purpose. If copying or transmitting this document to another, please copy or transmit it in its entirety.

Vision Series Lineup

The lineup covers everything from cost-effective Smart Cameras to ultra-high-speed Vision Systems.

Choose the best combination for your budget and needs.



Note: Do not use this document to operate the Unit.

OMRON Corporation Industrial Automation Company

Kyoto, JAPAN

Contact : www.ia.omron.com

Regional Headquarters

OMRON EUROPE B.V.

Wegalaan 67-69, 2132 JD Hoofddorp
The Netherlands
Tel: (31) 2356-81-300 Fax: (31) 2356-81-388

OMRON ELECTRONICS LLC

2895 Greenspoint Parkway, Suite 200
Hoffman Estates, IL 60169 U.S.A.
Tel: (1) 847-843-7900 Fax: (1) 847-843-7787

OMRON ASIA PACIFIC PTE. LTD.

438B Alexandra Road, #08-01/02 Alexandra
Technopark, Singapore 119968
Tel: (65) 6835-3011 Fax: (65) 6835-3011

OMRON (CHINA) CO., LTD.

Room 2211, Bank of China Tower,
200 Yin Cheng Zhong Road,
PuDong New Area, Shanghai, 200120, China
Tel: (86) 21-6023-0333 Fax: (86) 21-5037-2388

Authorized Distributor:

©OMRON Corporation 2012-2023 All Rights Reserved.
In the interest of product improvement,
specifications are subject to change without notice.

CSM_15_1

Cat. No. Q193-E1-12 1123 (0812)