

## Introduction

### What Is a Relay?

Basically, a Relay is a device with contacts that opens and closes a switch as the result of an input signal (voltage or current) applied to a coil.

- 1 Signal applied to an input coil.
- 2 Electromagnetism operates a motion.
- 3 The output contacts operate.

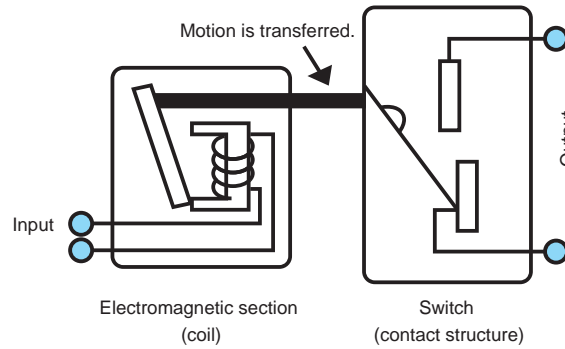

#### Other Names

- Electromagnetic relay
- Auxiliary relay
- Miniature relay
- Power relay etc.

To get an idea of what relays are, think of a children's athletic carnival. Little A holds on tightly to the baton and passes it to the big B. This is a relay.

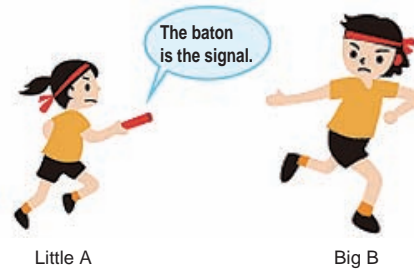

## Applications for Relays

Relays are widely used in most machines and devices that use electricity.

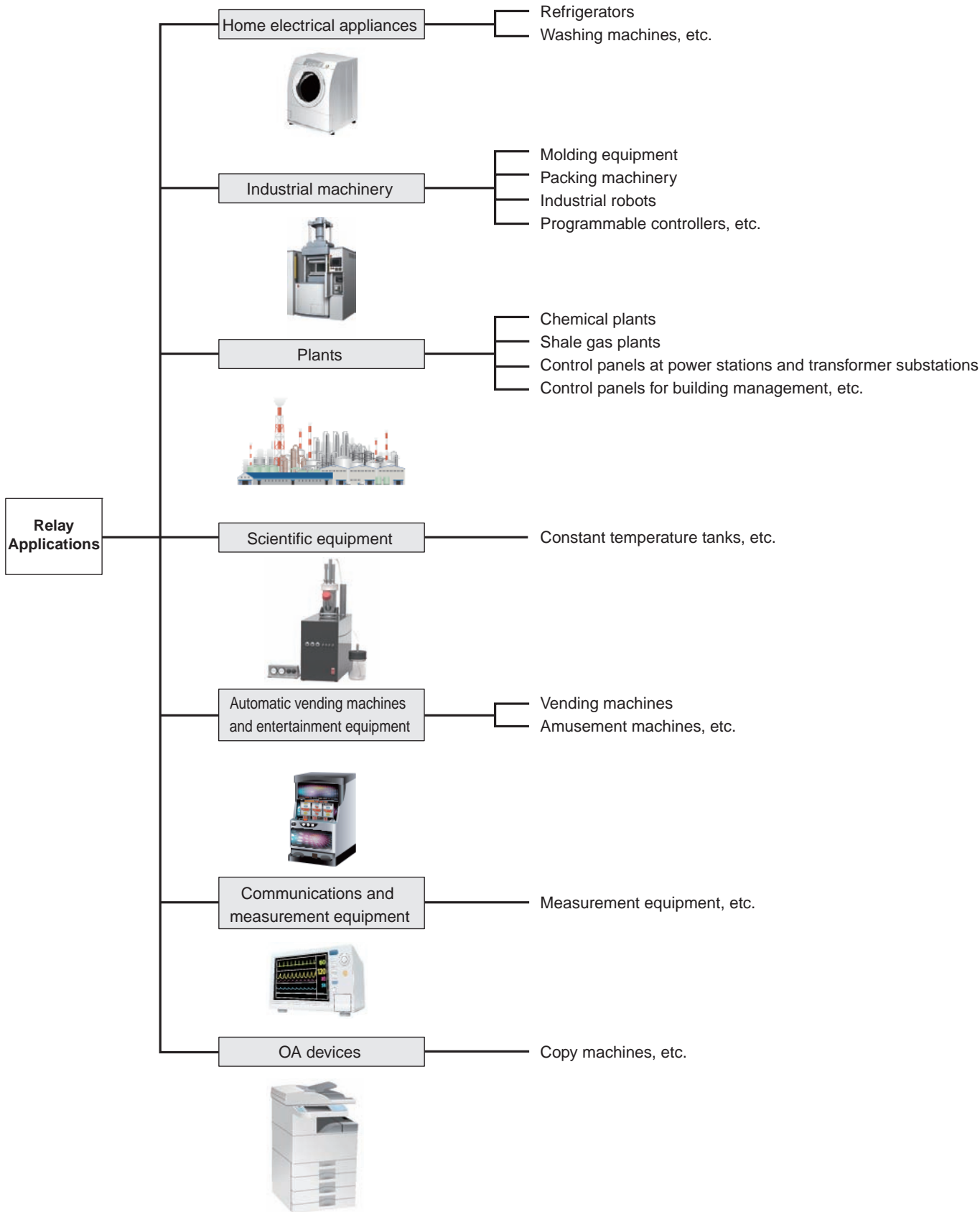

Sensors

Switches

Safety Components

Relays

Control Components

Automation Systems

Motion / Drives

Energy Conservation Support / Environment Measure Equipment

Power Supplies / In Addition

Others

Common

## Types of Relays

There are mainly two types of relays: mechanical relays and solid state relays. OMRON calls mechanical relays “General-purpose Relays.”

### Relays

#### Mechanical Relays

These relays transfer signals with mechanical motion.

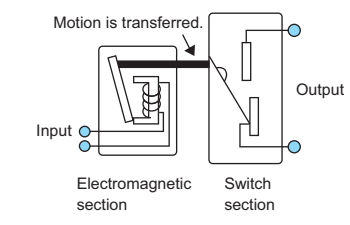

**Features**

Mechanical relays have contacts and use electromagnetic force to mechanically open and close the contacts to turn ON/OFF signals, currents, or voltages.

#### Solid State Relays (SSRs)

These relays transfer signals with electronic circuits.

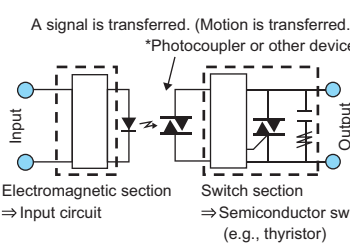

**Features**

SSRs do not have the mechanical moving parts that mechanical relays with contacts do. Instead they consist of semiconductors and electronic parts. SSRs turn ON/OFF signals, currents, or voltages electronically by the operation of these electronic circuits.

\* For details on SSRs, refer to the *Technical Explanation for Solid State Relays*.

There are various types of mechanical relays (General-purpose Relays).

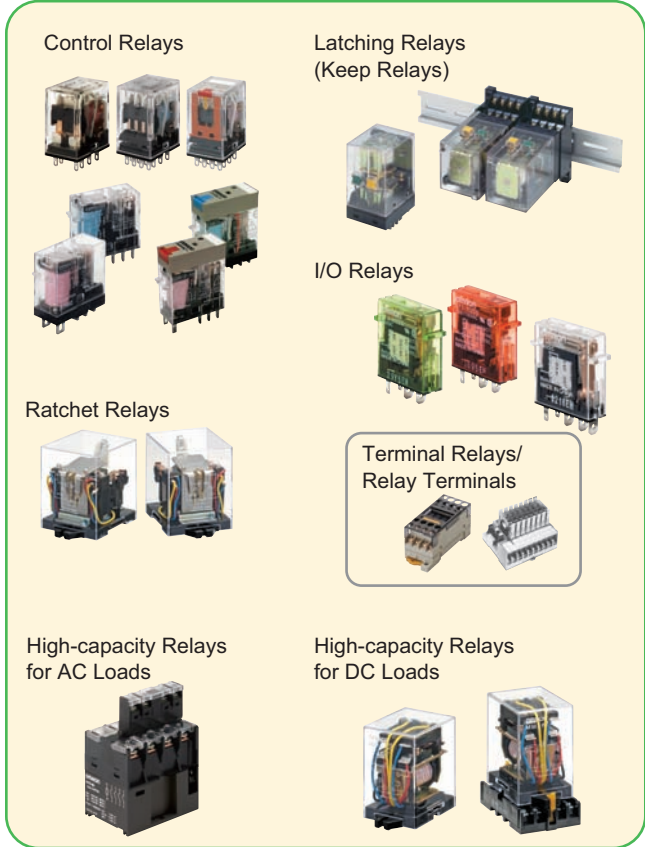

Hinged relays use the most common structure.



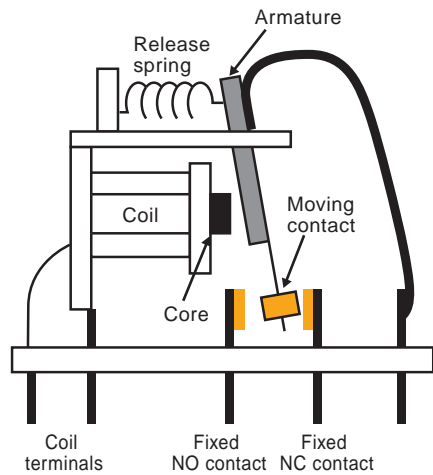

### Hinged Relays

With hinged relays, the armature of the electromagnet rotates around a fulcrum. This action directly or indirectly opens and closes a contact.



## Technical Explanation for General-purpose Relays

OMRON classified relays with contacts (General-purpose Relays) according to applications as shown in the following table.

Type	Points	Typical Relays
<b>Relays for control panels</b> <ul style="list-style-type: none"> <li>Control Relays</li> <li>I/O Relays</li> <li>Latching Relays, etc</li> </ul>	Relays with 1 to 4 poles are mainly used for relay sequences or I/O applications.	MM(K), MK(S), MY, LY, G2R(S), G2RV, G7T, etc. 
<b>Built-in relays</b> <ul style="list-style-type: none"> <li>High -capacity Relays, etc.</li> </ul>	Built-in relays enable using a carry current of up to 40 A and are used for building into devices, e.g., to turn ON load power supplies.	G7Z, G7J, G7X, etc. 
<b>Work-saving relays</b> <ul style="list-style-type: none"> <li>Terminal Relays</li> <li>Relay Terminals, etc.</li> </ul>	Work-saving relays are available in relay units and are used mainly for I/O applications for programmable controllers when downsizing and saving work are required.	G6D-F4B, G6B-4BND, etc. 
<b>Relays for special operations</b> <ul style="list-style-type: none"> <li>Ratchet Relays, etc.</li> </ul>	Relays for special operations are available as relays or relay units that are specified for a specific applications, such as alternative operation and stepping operation of pumps .	G4Q, G9B, MYA, etc. 
<b>Relays for PCBs *</b>	These specialized relays are mounted on PCBs.	G5NB, G2RL, etc. 

\* Refer to the *OMRON Electronic Components Web* (<https://components.omron.com/us-en/>) for information on relays for PCBs.

Sensors

Switches

Safety Components

Relays

Control Components

Automation Systems

Motion / Drives

Energy Conservation Support / Environment Measure Equipment

Power Supplies / In Addition

Others

Common

## Structure and Operating Principle

General-purpose Relays transfer signals through a mechanical action. A hinged relay is shown below as an example.

Hinged relays switch contacts by the rotating movement of an armature around a fulcrum.

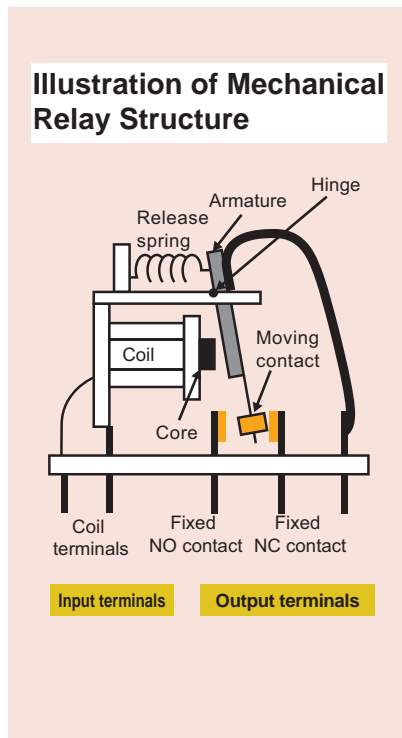

### Example: NO contacts (make contacts)

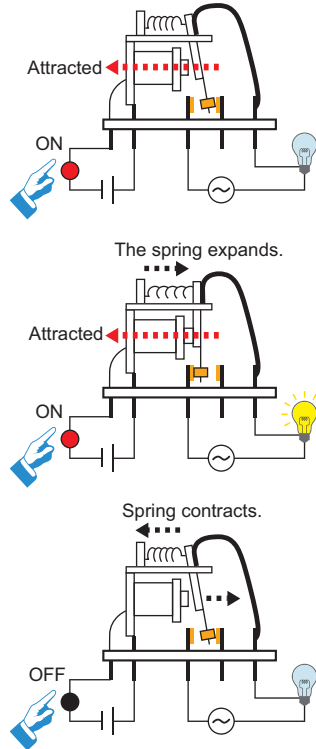

1. The input device (switch) is turned ON.
2. A current flows to the magnet (coil) to magnetize the core.
3. Magnetism causes the armature to be attracted to the core.
4. When the armature is attracted to the core, the moving contact touches the fixed contact and the lamp lights.  
**Note:** At this time, the release spring is stretched out.
5. The input device (switch) is turned OFF.
6. The current to the magnetic (coil) is cut off, the force of attraction is lost, and the force of the release spring returns the armature to its original position.
7. When the armature returns to its original position, the contacts separate and the lamp turns OFF.

**Application Examples:** Latching Relays (Also Called Bistable Relays or Keep Relays)  
Magnetic Latching Relays: Two-coil Latching Relays

## Relaxed State (after Reset)

- Battery Not Connected to Coil

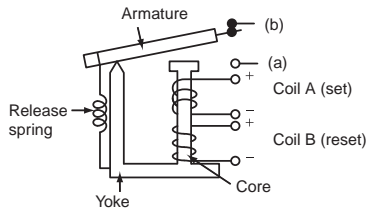

The diagram shows the relay in the relaxed state. These relays are the same as the hinged relays described previously except that the core, yoke, and armature are made from semi-hard magnetic material and there are at least two coils in the relay.

## Operating State (Set)

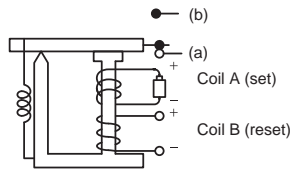

When current flows through coil A, the electromagnet (made of semi-hard material) is magnetized and the armature is attracted to the core.

As a result, the moving contact moves away from the normally closed (NC) contact (turns OFF) and makes contact with the normally open (NO) contact (turns ON).

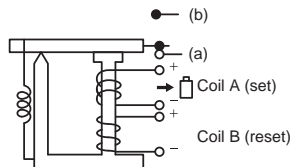

In the set state, the residual magnetic flux in the semi-hard magnetic material (material that has properties similar to a permanent magnet) will keep the armature attracted to the core even if a current is no longer applied to coil A.

## Release State (Reset) → Relaxed State

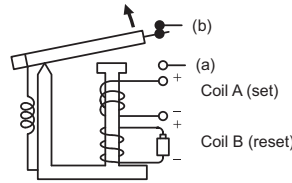

If a current is applied to coil B, which is wound in the opposite direction to coil A, the residual magnetic flux in the semi-hard magnetic material will be reduced and the magnetic attraction will weaken. The power of the release spring will become stronger than the magnetic attraction, so the armature will release and the relay will be in the relaxed state. When the armature has released, there will be almost no residual magnetic flux in the semi-hard magnetic material.

**Note:** In contrast to the hard magnetic material used in a permanent magnet, semi-hard magnetic material requires less energy to magnetize and de-magnetize.

Product Lineup

OMRON has a wide variety of General-purpose Relays so that you can select a relay that is suitable to the application.

Types of Relays (Typical Examples)

**Relays for Control Circuits (For Relay Sequences)**

**MY**

- Higher Load Capacity **MK**
- Circuit Operation Confirmation **MY(S)**
- Greater Contact Reliability (Minute Loads) **MY4Z**
- Greater Resistance to Environments **MYQ**
- Holding Circuit **MY2K**
- Large Number of Poles **MMX**
- Slim Relays **G2R-□-S**

Even Higher Load Capacity **MM**

Higher Load Capacity **MK-S**

Even Greater Contact Reliability (Minute Loads) **MY4Z-CBG**

Resistance to Corrosive Gases **MY4H**

Mechanically Held Relays **G7K**

Higher Load Capacity **MKK**

Even Higher Load Capacity **MMK**

Note: Mainly Two-pole Relays are used in control circuits.

**Relays for I/O Applications**

**G2R-□-S**

- High AC Capacity **LY**
- High DC Capacity **MMX**
- Minute Loads **G2RV-ST-AP**
- Slim Design **G7T**

Even Higher Capacity **G7J**

Even Higher Capacity **G7Z**

Even Higher Reliability **G7T**

Even Slimmer Design **G2RV-ST**

**Types of Terminal Relays**

Terminal Relays (4 Points)	I/O Relay Terminals (8 or 16 Points)
<b>G6B-4BND/4CB</b> <b>G6D-F4B</b>	<b>G7TC-I□ Series</b> <b>G7TC-O□ Series</b>

Note: Mainly One-pole Relays are used for I/O applications.

Sensors

Switches

Safety Components

Relays

Control Components

Automation Systems

Motion / Drives

Energy Conservation Support / Environment Measure Equipment

Power Supplies / In Addition

Others

Common

**Types of Square Sockets (Typical Examples)** \*Round Sockets are also available.

### Sockets for Front Mounting

**Terminal Types**

- Screws**
  - Phillips screws
  - Slotted screws
- Screwless**
  - Push-in
  - Clamps

**Main Models (Examples)**

<b>P2RFZ</b>	<b>PYFZ</b>	<b>P7SA</b>
<b>G2RV-ST700(ST701)</b>	<b>G3RV-ST700</b>	
<b>G2RV-ST500(ST501)</b>	<b>G3RV-ST500</b>	
<b>P2RF-□-S</b>	<b>PYF-□-S</b>	

### Sockets for Back Mounting

**Terminal Types**

- Soldered terminals
- PCB terminals
- Wire-wrap terminals

**Main Models (Examples)**

<b>P2R</b>	<b>PY</b>	<b>PT</b>
<b>P2R-□P</b>	<b>PY-02</b>	<b>P7SA-□P</b>
<b>PY□QN</b>	<b>PT□QN</b>	

Sensors  
Switches  
Safety Components  
Relays  
Control Components  
Automation Systems  
Motion / Drives  
Energy Conservation Support / Environment Measure Equipment  
Power Supplies / In Addition  
Others  
Common



## Explanation of Terms

### General Relay Terms

#### Relay

A device designed to cause a sudden, predicted change in a single or multiple electrical output circuits when certain conditions are satisfied by the electrical input circuit that controls the relay device.

**Note:** Relays can be classified into electromechanical relays that are used for mechanical operations and static relays that are not. Based on the operating principles, further classification includes electromagnetic relays, thermal relays, piezo-electric relays (electrostrictive relays), and contactless relays. The IEC classifies relays into all-or-nothing relays, which set and reset based on whether the input quantity is within the operating region or is effectively zero, and measuring relays, which are set when the characteristic quantity with a specified precision reaches the operating value.

#### DC Relays

Relays designed to operate with a DC input.

#### AC Relays

Relays designed to operate with an AC input.

#### Polarized Relays

DC relays that change status depending on the polarity of the control input current.

**Note:** There are single-side stable relays, double-sided stable relays, and centrally stable relays. Relays that are not affected by the polarity of the control input current are called nonpolarized relays (neutral relays).

### Contact Section

#### Contact Configuration

The contact configuration is called to the contact mechanism. Types of contacts include NC contacts (break contacts), NO contacts (make contacts), and transfer contacts.

#### Number of Contact Poles

The number of contact poles is referred to the number of contact circuits.

#### Contact Symbols

The following symbols are used according to the contact mechanism.

	NO contacts	NC contacts	Transfer contacts	MBB contacts
Catalog contact symbols				
JIS contact symbols				

**Note:** Except for special cases, JIS contact symbols are used in the *Technical Explanation for General-purpose Relays and Safety Precautions for All Relays*.

#### Static Relays

Static relays are designed to get a response not from a mechanical operation but rather from an electrical, electromagnetic, or optical action.

**Note:** Solid-state relays (SSRs) fall into this category.

#### Flexure Type

Flexure is a type of drive method for the contact spring. With flexure-type relays, the contacting force is obtained from a stud, card, or other pushing force.

#### Sealed Relays

Relays that are completely encased in a container and sealed.

**Note:** Generally, sealed relays are sealed in a metal and metal or metal and glass container by welding or similar method. Enclosed relays are sometimes called sealed relays even though they are simply closed without using welding or similar sealing methods.

#### Hinged Relays

Hinged relays are classified by the structure of the electromagnet. Hinged relays directly or indirectly switch contacts by the rotating movement of an armature around a fulcrum.

**Note:** Hinged relays with armatures that move at right angles to the core axis direction are called side armature type hinged. Those with armatures that move in the direction of the axis are called end-on armature type hinged relays.

#### Plunger Relays

Plunger relays are classified by the structure of the electromagnet. The armature in a plunger relay is at the center of the coil and it moves along the coil axis.

#### Lift-off Type

Lift-off is a type of drive method for the contact spring. After contact, the card or stud separates from the contact spring and the contacting force is derived from the residual bend in the moving spring.

**Note:** The pressure of a coil spring is also sometimes used.

#### Intersecting Contacts

Contacts that have intersecting bars.



Example of Single Cross Bars

#### Twin Contacts

Opposing contact springs act as a pair and a contact is attached to the tip of each spring, which increases the contact reliability.

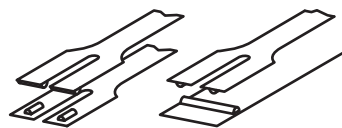

Example of Twin Cross Bars

#### Moving Contact

A moving contact is directly driven a drive mechanism or by part of it. The contact that is not directly driven is called the fixed contact.

#### Stationary Contact

A stationary contact is designed for continuous contact.

**Note:** Terminals, connectors, etc., fall into this group. The term "stationary contact" is sometimes used to indicate a fixed contact, the opposite of a moving contact.

## Make Contacts (NO Contacts)

The contacts in relays or switches that are normally open and close upon operation are called NO contacts. They are also called front contacts.

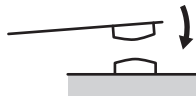

## Break Contacts (NC Contacts)

The contacts in relays or switches that are normally closed and open upon operation are called NC contacts. They are also called back contacts.

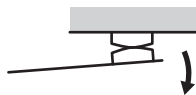

## BBM (Break Before Make) Contacts (Non-shorting Contacts)

BBM contacts are part of the group of contacts that have a specified operating sequence. BBM contacts are a set of contacts in which the contacts that should open at operation open before closing the contacts that need to close. They are also called transfer contacts.

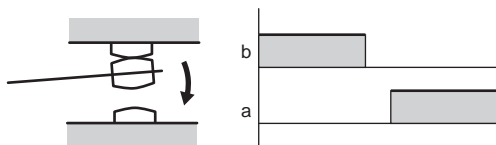

## MBB (Make Before Break) Contacts (Shorting Contacts)

MBB contacts are part of the group of contacts that have a specified operating sequence. MBB contacts are a set of contacts in which the contacts that should close at operation close before opening the contacts that need to open. These are also called continuous contacts.

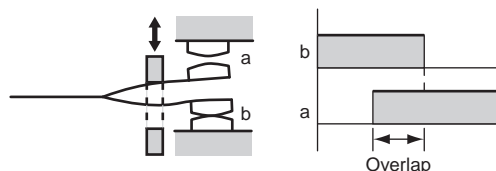

## Contact Springs

Springs for adding contacting force to the contact's contacting section.

## Opening Force

The force that operates on a contact to open it.

## Opening Speed

The operating speed when a closed contact opens.

## Contact Gap

The gap between a set of contacts when they are open.

**Note:** This is the shortest distance between two conductors that make up the contacts.

## Clearance

The shortest distance between two isolated bare live parts that must be isolated from each other.

## Creeping Distance

The shortest distance along the surface of an insulating material placed between two bare live parts that must be insulated from each other.

## Double-Throw

A set of contacts that have two contact positions, each of which closes a different circuit. Contact sets consisting of only one contacting position for closing the circuit are called single-throw contacts.

## Wiping Action

The sliding action performed after two opposing contacts make contact. This wiping action helps to reduce the impact of film or dust that collects on the surface of contacts.

## Rated Load

A standard value for stipulating contact performance, expressed as a combination of contact voltage and contact current.

## Rated Carry Current

The current that can be supplied continuously to a contact without exceeding the maximum temperature when the contact is not switching.

## Maximum Switching Capacity

The maximum load capacity that can be switched. Design circuits to ensure that this value is not exceeded during operation. The maximum switching capacity is expressed as VA for AC relays and W for DC relays.

## Failure Rate

The percentage of failures per unit time (or number of operations) during continuous relay switching under individually specified test types and loads.

The failure rate will depend on the switching frequency, the environmental conditions, and the expected reliability level. Failure rates must always be checked on equipment under real operating conditions.

In this catalog, the failure rate is given as the P level (reference value). This expresses the failure level at a reliability level of 60% ( $\lambda_{60}$ ) (JIS C5003).

Level	Failure rate (/operation)
∴	
L	$5 \times 10^{-6}$
M	$1 \times 10^{-6}$
N	$0.5 \times 10^{-6}$
P	$0.1 \times 10^{-6}$
Q	$0.05 \times 10^{-6}$
∴	

Example:  
 $\lambda_{60} = 0.1 \times 10^{-6} / \text{operation}$  means that 1 failure can be expected in 10,000,000 operations at a reliability level of 60%.

## Contact Resistance

The contact resistance is a combination of the inherent resistance of the conductors that make up the armature, terminals, contacts, and other parts, the boundary resistance where the two contacts meet, and the concentrated resistance.

The contact resistances given in this catalog are the initial specified values. The size of the values does not indicate performance during actual operation.

The contact resistance is measured using the voltage drop method (four-terminal method) shown in the following diagram by applying the measurement currents stipulated in the following table.

$$\text{Contact resistance} = \frac{V}{I} (\Omega)$$

(The contact resistance for DC relays is the average of measured values for both for forward and reverse polarity.)

## Test Currents (JIS C5442)

Rated current or switched current (A)	Test current (mA)
Less than 0.01	1
0.01 or higher but less than 0.1	10
0.1 or higher but less than 1	100
1 or higher	1,000

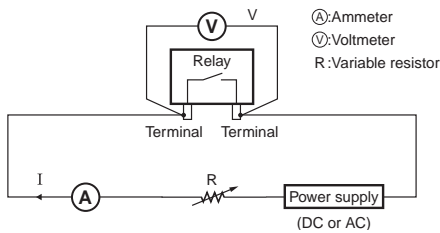

## Maximum Contact Voltage

The maximum value of the contact voltage that can be switched. Never exceed this value during operation.

## Maximum Contact Current

The maximum value of the contact current that can be switched. Never exceed this value during operation.

## Bounce

Undesirable intermittent switching that occurs between contacts when they are turned ON or OFF.

The time that this intermittent switching continues is called the bounce time. The operating time and release time does not include the bounce time.

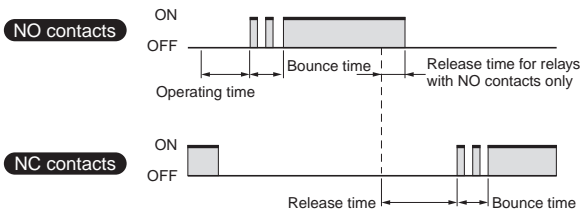

## Chattering

The problem where an ON contact repeatedly switches due to an external cause. The time that chattering continues is called the chattering time.

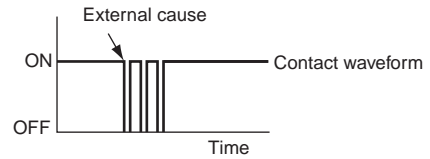

The following diagram shows the relationship between bounce and the response of each part when a coil turns ON.

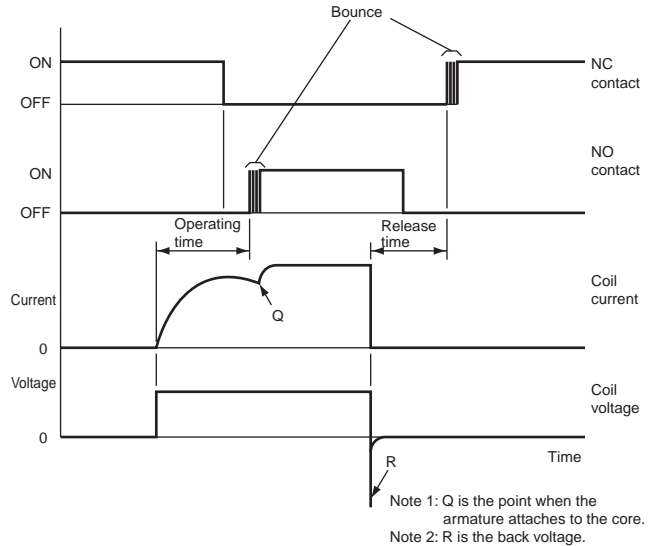

## Measurement Circuit

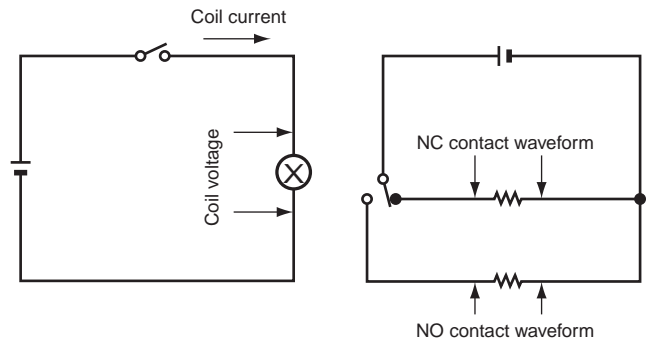

## Gluing

Contacting surfaces cannot be opened easily, even though they are not fused together or mechanically caught.

**Note:** Gluing occurs easily for contact surfaces of a low hardness that are clean.

## Welding

Contacting surface and surrounds fuse together and are difficult to open.

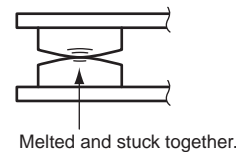

## Locking

Deformation due to contact wear and transfer causes opposing contacting surfaces to become mechanically caught and difficult to open.

## Transfer

Contacting surfaces and the surrounds are affected by electrical discharge or Joule heat and part of the material from one contact transfers to the other opposing contact.

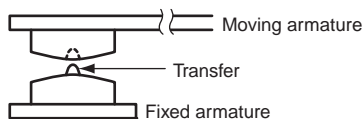

**Note:** Transfer caused by discharge was previously called large transfer and transfer from other causes was called small transfer.

## Anode Arc

An arc that transfers contact material from the anode side to the contact surface on the cathode side.

**Note:** It is said that the direction of the transfer is affected by the contact materials, the balance of heat in a circuit, etc.

## Cathode Arc

An arc that transfers contact material from the cathode side to the contact surface on the anode side.

## Coherer Effect

The problem where the contact resistance drops dramatically for contacts that make contact through a contact film because the contact voltage has exceeded a certain value causing that film to be electrically damaged.

## Black Powder

Carbon generated by the electrical switching operation of contacts that attaches to the surface of contacts and causes activation.

## Brown Powder

A brown or black-brown organic compound in powder form that is created by the reactions of organic gases on contact surfaces.

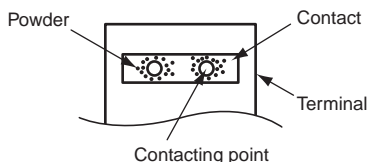

**Note:** Brown powder is generated by the rubbing action of contacts when certain organic gases are present in the operating environment, mainly during switching of platinum contacts, and can cause contact damage.

## Coil Section

### Coil Symbols

The following diagrams are used to indicate the coil drive types.

Single stable coils		Double-winding latching coils		Single-winding latching coils
Polarized coils	Non-polarized coils	4-terminal coils	3-terminal coils	

### Rated Voltage

The standard voltage applied to the operating coil when a relay is used under normal conditions.

## Insulation Breakdown

Sudden loss of insulation due to the voltage applied to two electrodes either side of an insulating material.

## Compound Contacts

Contacts made from two or more layers of different materials.

## Joined Contacts

Contacts made of two different metals pasted together.

## Diffusion Alloy Contacts

Contacts made using diffusion processing.

## Multi-layer Contacts

Contacts with a multi-layer construction, using plating, joining, or other method.

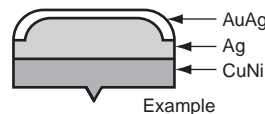

## Plated Contacts

Contacts with plating on the contacting surfaces.

## Sintered Contacts

Contacts created using powder metallurgy.

**Note:** There are various types of these contacts, such as metal sintered contacts and compound sintered contacts.

## Inrush Current

A current larger than normal that flows instantaneously or transiently when a contact is closed.

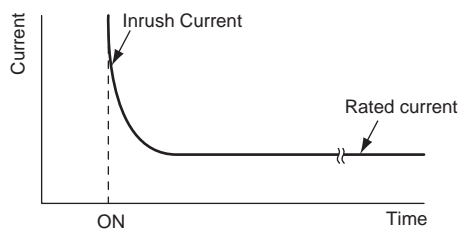

## Rated Current

The standard current that flows to the coil to enable use a relay under normal conditions.

The value is given at a coil temperature of 23°C. The tolerance, unless otherwise specified in the model specifications, is +15% and -20%.

## Coil Resistance

The coil resistance is the resistance between the coil terminals when the coil temperature is 23°C.

The tolerance is ±15% unless otherwise specified in the model specifications.

(The coil resistance for AC specifications and the coil inductance are the reference values.)

## Rated Power Consumption

The power consumed by the coil when the rated voltage is applied to the coil (rated voltage x rated current). The rated power consumption for AC specifications is the value at a 60-Hz frequency.

## Must-operate Voltage

The minimum voltage required to operate a relay (JIS C5442). The value is given at a coil temperature of 23°C.

## Must-release Voltage

The maximum voltage at which the relay will release when the voltage drops dramatically or gradually (JIS C5442). The value is given at a coil temperature of 23°C.

### Example: MY4 DC Relay

The distributions of the must-operate voltage and the must-release voltage are shown in the following graph. As shown in the graph, the relay operates at voltages less than 80% of the rated voltage and releases at voltages greater than 10% of the rated voltage.

Therefore, in this catalog, the operating and must-release voltages are taken to be 80% max. and 10% min. respectively of the rated voltage.

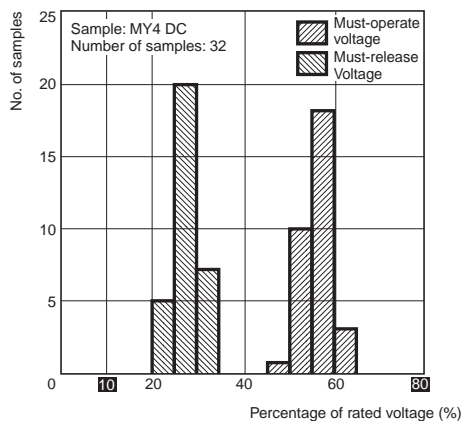

### Example: G2R-1 DC Relay

The distributions of the must-operate voltage and the must-release voltage are shown in the following graph. As shown in the graph, the relay operates at voltages less than 70% of the rated voltage and releases at voltages greater than 15% of the rated voltage.

Therefore, in this catalog, the operating and must-release voltages are taken to be 70% max. and 15% min. respectively of the rated voltage.

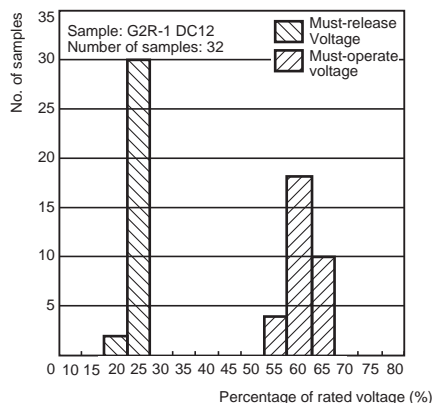

## Hot Start

The status power is supplied to contacts and the power that has been supplied to the coil is turned OFF then ON. The must-operate voltage at that time is given. (The coil voltage, contact current, and ambient temperature are set as conditions.)

## Minimum Pulse Width

For a latching relay, the minimum pulse width of the rated voltage applied to the coil to set and reset the contacts. The value is the rated voltage applied to the coil at an ambient temperature of 23°C.

## Coil Inductance

For a DC relay, the value found from the time constant when a rectangular wave is applied. For an AC relay, the value is given at the rated frequency. The values are different for operation and release.

## Core

A magnetic body inserted in the coil to effectively operate the magnetomotive force in an electromagnet. **Note:** The term core is used mainly for fixed magnetic objects. Those that move inside the coil are called moving cores. Sometimes pole pieces are attached to effectively utilize the magnetic attraction.

## Shading Coil

A short-circuited coil for partially delaying the change in magnetic flux by using the current generated by mutual inductance between the magnetic pole of a DC electromagnet that has been partially encased and an excitation coil. Shading coils reduce the vibration of the moving parts.

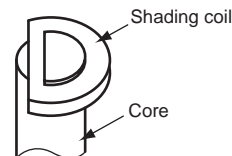

## Electrical Characteristics

### Operating Time

The time between the moment the rated voltage is applied to the coil and when the contacts operate.

For relays with more than one contact, the operating time is the time until the slowest contact operates, unless otherwise defined (JIS C5442).

The operating time is given for a coil temperature of 23°C and does not include bounce time.

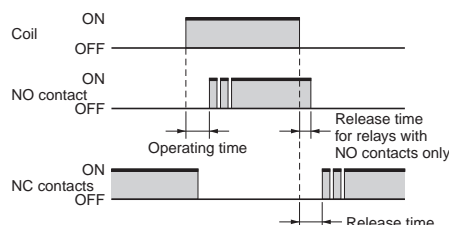

### Set Time (Latching Relays Only)

The time from the moment when the rated voltage is applied to the set coil until the contacts operate.

For relays with more than one contact, the set time is the time until the slowest contact operates, unless otherwise defined (JIS C5442).

The set time is given for a coil temperature of 23°C and does not include bounce time.

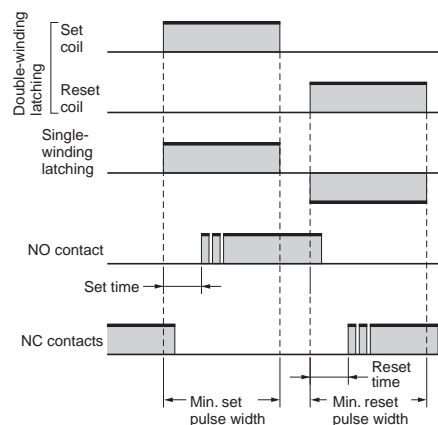

### Release Time

The time from the moment the rated voltage is removed from the coil until the contacts release.

For relays with more than one contact, the release time is the time until the slowest contact releases, unless otherwise defined (JIS C5442).

For relays with only NO contacts, the release time is the time until the slowest NO contact opens.

The release time is given for a coil temperature of 23°C and does not include bounce time.

### Reset Time (Latching Relays Only)

The time from when the rated voltage is applied to the reset coil until the contacts release.

For relays with NO contacts only, the reset time is the time until the slowest NO contact opens.

For relays with more than one contact, the reset time is the time until the slowest contact releases, unless otherwise specified.

The reset time is given for a coil temperature of 23°C and does not include bounce time.

### Bounce

Intermittent switching between contacts due to shock and vibration caused by the impact between the moving parts of relays (armatures) colliding with the core or other contacts (JIS C5442).

### Operating Bounce Time

The bounce time for NO contacts when the coil rated voltage is applied at a coil temperature of 23°C.

### Release Bounce Time

The bounce time for NC contacts when the coil rated voltage is removed at a coil temperature of 23°C.

### Switching Frequency

Number of relay operations per unit time.

### Insulation Resistance

The resistance of the isolated sections between contacts and coils, conducting terminals and uncharged metallic parts (e.g., core frame and core), or between contacts.

This value is given for the relay and does not include lands on PCBs.

- (1) Between coils and contacts:  
Between coil terminals and all contact terminals
- (2) Between contacts with different polarity:  
Between contact terminals of different polarity
- (3) Between contacts with the same polarity:  
Between contact terminals with the same polarity
- (4) Between set coils and reset coils:  
Between set coil terminals and reset coil terminals

### Dielectric Strength

The maximum value before insulation damage occurs when voltage is applied for one minute to an isolated metallic part (especially charged metal part).

The voltage is applied at the same location as the insulation resistance.

The leakage current (the current used to detect insulation damage) is normally 1 mA.

Sometimes, however, a leakage current of 3 mA or 10 mA is used.

### Impulse Withstand Voltage

The maximum abnormal voltage that the relay can withstand when the voltage surges momentarily due to lightning, switching an inductive load, etc.

The surge waveform, unless otherwise specified, is the standard impulse voltage waveform according to JIS C5442, i.e.,  $1.2 \times 50 \mu\text{s}$ .

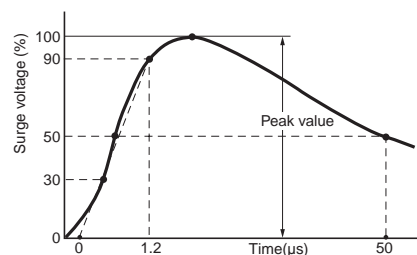

FCC Part 68 specifies  $10 \times 160 \mu\text{s} \pm 1,500 \text{ V}$ .

### Vibration

The vibration resistance of a relay is divided into two categories: Destruction, which quantifies the characteristic changes of, or damage to, the relay due to considerably large vibrations which may develop during the transportation or mounting of the relay, and malfunction durability, which quantifies the malfunction of the relay due to vibrations while it is in operation.

$$\alpha = 0.002f^2 A \times 9.8$$

$\alpha$  : Acceleration of vibration ( $\text{m/s}^2$ )  
 $f$  : Frequency (Hz)  
 $A$  : Double amplitude (mm)

## Shock

The shock resistance of a relay is divided into two categories: Destruction, which quantifies the characteristic change of, or damage to, the relay due to considerably large shocks which may develop during the transportation or mounting of the relay, and malfunction durability, which quantifies the malfunction of the relay while it is in operation.

## Mechanical Durability

The durability of contacts when no load is applied and the contact is switched at a specified switching frequency.

## Electrical Durability

The durability of contacts when a rated load is applied and the contact is switched at a specified switching frequency.

## Problems and Status

### Flashover

The problem where discharge between opposing conductors causes a short-circuit. This often occurs with contacts used with medium and large currents.

### Sticking

Welding, locking, or gluing make it difficult to open contacts.

### Contact Wear

The wear of contacts due to mechanical causes, such as wear during repeated operation.

### Contact Erosion

The expanding of contacts due to electrical, thermal, chemical, and other causes during repeated operation.

### Activation

The problem where contact surfaces become dirty and discharge occurs more easily.

**Note:** If precious metal contacts switching in an environment with certain types of organic gases present, the organic gas that attaches to the surface of the contacts will break down as a result of the discharge and create black powder (e.g., carbon), which makes discharge more likely to occur.

## Operating Forms

### Single-stable (Standard) Relays

Relays where the contacts switch based on the non-excitation and excitation of the coil and otherwise have no special functions based on operating elements.

Terminal Arrangement/  
Internal Connections  
(Bottom View)

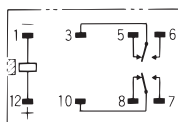

### Double-winding Latching Relays

Relays with a set coil and reset coil and a latching configuration to hold the set status or reset status.

Terminal Arrangement/  
Internal Connections  
(Bottom View)

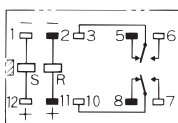

S: Set coil  
R: Reset coil

## Thermoelectromotive Force

If different metals are attached at both ends and the temperatures where the metals are connected are held at different temperatures, current will flow in one direction in the circuit. The electromotive force that causes this current is called thermoelectromotive force.

Thermoelectromotive force occurs between the different metals in terminals, armatures, and contacts in relays. This thermoelectromotive force is the reason the actual temperature and the measured temperature are different when relays are used to switch thermocouples.

### Contact Film

Metal oxide, sulfide, and other films that are generated on or attach to contact surfaces and cause boundary resistance.

### Fringing Effect

The magnetic characteristics caused by the shape around directly opposing magnetic surfaces.

### Humming

Noise due to mechanical vibration caused by AC poles or a rectifier wave drive with insufficient smoothing.

### Soak

Removing the difference due to the effect of the magnetic history by applying a saturation current to the operating coil during measurement of the must-operate and must-release voltage (or current) or during testing.

**Note:** The current that is used is called the soak current.

### Single-winding Latching Relays

Relays with one coil and a latching configuration that can switch to and hold a set or reset status according to the polarity of the applied voltage.

Terminal Arrangement/  
Internal Connections  
(Bottom View)

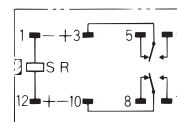

S: Set coil  
R: Reset coil

### Stepping Relays

Relays that turn multiple contacts ON and OFF in order each time an input pulse is received.

### Ratchet Relays

Relays that perform a type of stepping operation, where the contacts alternate between ON and OFF for each input pulse.

## Dimensions and Shapes

### Dimensions

For general-purpose relays, the maximum dimensions are listed as guides for design. Limited to relays characterized by their small size. The maximum dimensions and the average dimensions (indicated in parentheses and marked with an asterisk \*) are both indicated as guides for design.

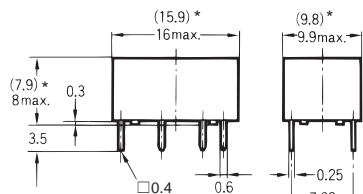

\* Indicates the average dimensions.

### Marking

The markings on the relay itself include the model, the voltage specifications, etc., as well as the internal connections. Some small relays do not have internal connections shown on the relay itself.

## PCB Relays

### High-frequency Isolation

Indicates the degree of high-frequency signal leakage between open contact terminals and unconnected terminals.

### Insertion Loss

The loss of a high-frequency signal between closed contact terminals.

### Return Loss

The quantity of high-frequency signal reflection that occurs in a transmission path.

### V.S.W.R.

The voltage standing-wave ratio that occurs in a transmission path.

**Note:** Formula for converting return loss to V.S.W.R.

$$V.S.W.R. = \frac{1 + 10^{-\frac{X}{20}}}{1 - 10^{-\frac{X}{20}}}$$

x: Return loss

### Example Method for Measuring High-frequency Characteristics

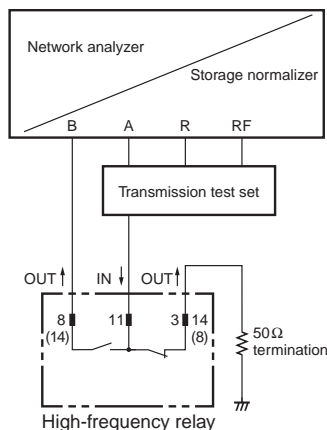

Contacts that are not related to the measurement are terminated at 50 Ω.

### Maximum High-frequency Carry Power

The maximum high-frequency signal power that can pass between closed contact terminals.

### Maximum High-frequency Switching Power

The maximum high-frequency signal power that a contact can switch. The electrical durability will be shorter than for the rated load.

### Crosstalk Characteristic

The degree of high-frequency signal leakage between contact circuits.

### TV Rating (UL/CSA)

The TV rating is one of the common ratings used to evaluate the inrush current resistance characteristics in the UL and CSA standards. It indicates the load switching level for a relay, including the inrush current.

A tungsten lamp is used as the load in the switching test (durability test) and a switching durability of 25,000 times total is required.

TV rating	Inrush current	Steady-state current	Example models
TV-3	51 A	3 A	G2R-1A LY2 G2R-1 (N.O. only) G2R-2 (N.O. only)
TV-5	78 A	5 A	G5RL-1A(-E)-LN LY1
TV-8	117 A	8 A	G4W-1112P-US-TV8 G5RL-U1A-E G5RL-K1A-E
TV-10	141 A	10 A	G7L G7J (N.O. only)
TV-15	191 A	15 A	G4A



## Direction Marks

The marks used mostly on PCB relays to show the coil direction.  
This makes it easier to determine the relay coil direction when designing patterns for PCBs and installing PCBs.

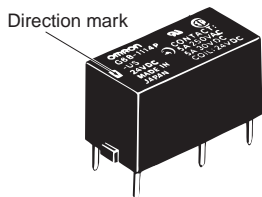

	PCB mounting dimensions	Terminal arrangement/ internal connections
Symbol		
Usage example		

**Note:** The external dimensions, PCB mounting dimensions, and terminal arrangement/internal connections all have the direction mark on the left.  
JIS contact symbols are not used, in order to match the case markings.

## Terminal Arrangement/Internal Connections

### 1. Top View

Limited to relays with terminal arrangements that can be seen from the top, as shown in the diagram. The internal connections are drawn showing a top view of the relay.

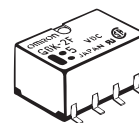

### 2. Bottom View

Limited to relays with terminals that cannot be seen from the top, as shown in the diagram. The internal connections are drawn showing a bottom view of the relay.

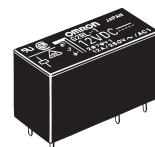

### 3. Bottom View Rotation Direction

The terminal arrangements for PCB relays are shown with the relay is rotated in the direction of the arrow when the coil is on the left (direction mark on the left).

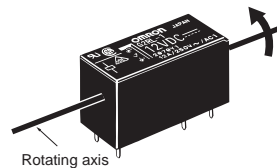

## Further Information

### FAQs

**?** What is the value in parentheses for models with the coil voltage listed as “100/(110) VAC”?



“100/(110) VAC” indicates that the coil has three ratings.

- Three Ratings
- 100 VAC 50 Hz
- 100 VAC 60 Hz
- 110 VAC 60 Hz

If the specification is listed as “100/110 VAC,” the coil has four ratings, i.e., it also has the following rating: 110 VAC 50 Hz.

For example, the MY and LY Relays have four ratings.

**?** Do the operating and release times include bounce time?



No, they do not.

Operating time:

The time from when power is supplied to the coil until the NO contact (make contact) turns ON.

Release time:

The time from when the coil turns OFF and the NO contact (make contact) turns OFF (or, for transfer contacts, until the NC contact is reached).

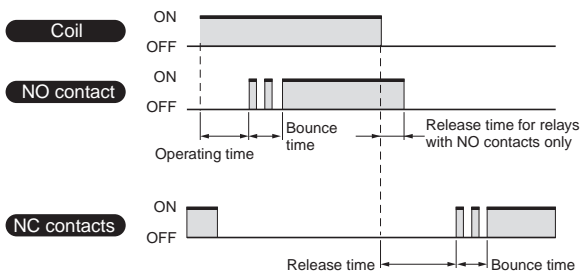

**?** Is the switching capacity doubled if two relay contacts are connected in parallel?



No, it is not.

The two contacts are not always going to turn ON/OFF at the same time (there may be a slight delay) so one contact will bear the full load momentarily.

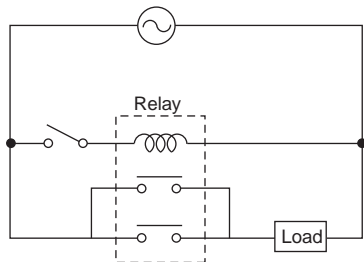

**?** What are twin-contact relay models suitable for switching minute loads?



The highly reliable crossbar twin contact or twin contact relays are recommended for switching minute loads.

#### Series Suitable for Minute Loads

Crossbar twin contacts:

G7T Series and MY4Z-CBG Series

Twin contacts: MY4Z Series and MK□ZP Series

**?** How should the contact reliability be viewed in minute load ranges?



The contact resistance of contacts sometimes becomes a problem when switching minute loads. Sometimes contacts recover during the next operation even if there is random high contact resistance.

The contact resistance may also be increased by the generation of film on the contacts.

Whether or not the contact resistance will cause a problem in the circuit must be a factor used to determine if the contact resistance value constitutes a failure or not. For this reason, only the initial value is specified as reference for contact resistance failure for a relay. Failure rates are expressed as P levels (reference values) with the minimum applicable load used as a guide. Some relay contacts are suitable for minute loads and some are not.

## Influence of External Conditions, Environment, and Atmosphere on Relays

### Coils

#### Relationship with Power

(1) For a DC relay, the relationship is as follows:

$$\text{Coil current} = \frac{\text{Applied voltage}}{\text{Coil resistance}}$$

(2) For an AC relay, the coil impedance must be taken into account because it is affected by the coil inductance. The coil impedance varies with the frequency. If the characteristic at 60 Hz is 100%, using the same relay at 50 Hz will produce the characteristics shown in the following table.

These values will depend on the type of relay. Check the values before using a relay.

Rated current, power consumption, and temperature rise	Approx. 117%
Must-operate current	Approx. 100%
Must-operate voltage and must-release voltage	Approx. 85%

(3) Be careful of the following points: DC relays, such as keep relays and relays with built-in operation indicators or surge-absorbing diodes, have polarity. If the relay is connected incorrectly, elements may be destroyed or malfunction. Applying a DC voltage to an AC relay will cause the coil to heat. This may lead to burning. Applying an AC voltage to a DC relay will cause the armature to vibrate and the relay will not operate properly.

#### Relationship with Temperature

Temperature changes affect the resistance of the copper wires used for coils by approximately 0.4% per °C. This directly affects the relay characteristics because the coil current, which generates the attractive force of an electromagnet, to change.

The effect of temperature on the operating characteristics (such as the must-operate voltage and must-release voltage) of an AC relay is smaller because the ratio of DC resistance of the coil to the coil impedance is small.

Changes in coil resistance also affect the coil temperature for DC relays. This is because a change in coil current causes the amount of power that is consumed to change. The value of temperature rise changes according to the rate of change in the coil current due to changes in the temperature. A typical example is shown in the following figure.

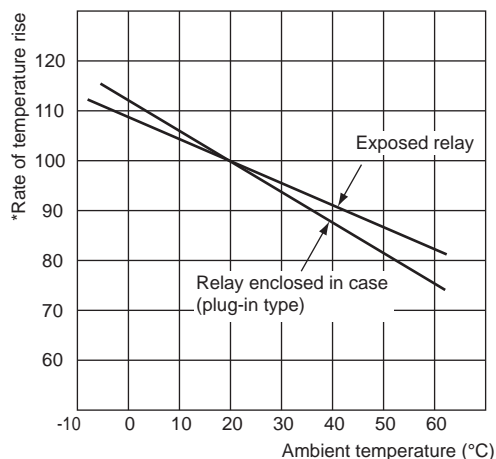

\* This is the percentage of coil temperature rise caused by a 20°C increase in ambient temperature.  
Change in coil temperature caused by change in ambient temperature.

#### Definition of Ambient Temperature

The temperature inside the box increases because of heat generated by the relays and other devices.

The ambient temperature that must be used is the temperature inside the box near the relay.

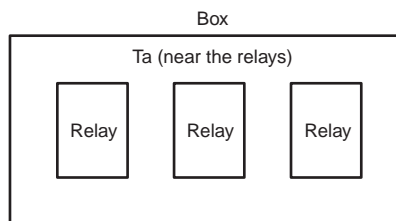

#### Electrolytic Corrosion

If the relay coil is not a operating state, exposure to high temperatures or high humidity when there is a potential difference between the coil and other metals, such as the core, may cause the copper wire coil winding to corrode. The corrosion is caused by ionized current passing between the metals when the insulation between them is insufficient.

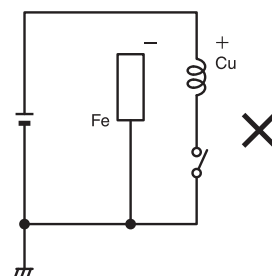

This can be made analogous to the process of creating metal plating. The effect is accelerated when acid or base is involved.

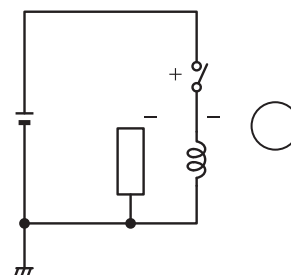

Not a lot of attention has been paid to this effect in the past; however, recently good quality plastics have been developed for spooling, and insulation materials, such as polyurethane, polyester, polyamide, and fluorine resin, have also been developed for the winding. These modern plastics reduce the effect of electrolytic corrosion.

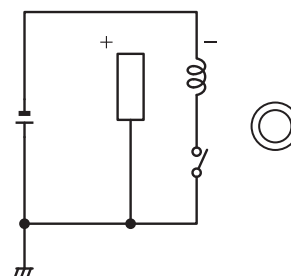

To prevent electrolytic corrosion, avoid storage in locations with high temperature or high humidity. Thought must be given to the circuit layout, such as positioning the switch so that the winding is not subject to a constant positive voltage, or create a positive ground. Good and bad examples are shown on the right.

## Operating Time

### Relationship between Shape of Relay and operating Time

The operating time of the relay is determined by the coil time constant, delay time due to the moment of inertia, and the contact switching time. These values differ with the shape of the relay. For example, relays with a large gap between the core and the armature or relays that have electromagnets made from materials with a large magnetic resistance, have small inductance values, and the time constant is small. However, this weakens the attractive force, hence more time is required to attract the armature. This phenomenon often occurs in DC operation. The magnetic attraction is weakened because it is inversely proportional to the square of the distance between the core and the armature. For high-speed relays, the gap is made smaller and material with high magnetic permeability is used to reduce the amount of coil winding.

In AC operation, a current larger than the rated current is drawn when power is supplied. The shape of the relay is not as relevant as it is for DC operation.

The moment of inertia has an indirect driving force that prevents large loads on the armatures when they begin to move.

Movement of the armature practically dictates the contact switching time. For this reason, the load and the attractive force must be balanced so that the armature movement is as small as possible, and it moves smoothly through all stages of the movement. Contact bounce is affected by factors such as the moving speed of the armature, quality of the moving parts, and springiness of the contact springs.

Generally, the shape of the contact spring, the contact segment, or the structure of the stopper is designed to dampen the shock from the movement.

### Relationship between Voltage/Current Applied to Coils and Operating Time

The relay operating time is affected by the voltage/current applied to the coils.

As shown in the following figure, when a voltage slightly higher than the must-operate voltage is applied, the time taken for the coil current to reach the must-operate current, the time taken for the moving parts to overcome inertia and start moving, and the time taken for the attractive force to overcome the weight of the load and switch the contacts all become longer, therefore the operating time is considerably longer.

When a voltage much higher than the must-operate voltage is applied, all the times become shorter, and therefore the operating time becomes shorter.

The relationship between the voltage applied to the coil and operating time is as explained above, however, the voltage applied to the coil also affects other characteristics. This is why a rated coil voltage is specified.

### Relationship between Applied Coil Voltage/Current and Operating Time

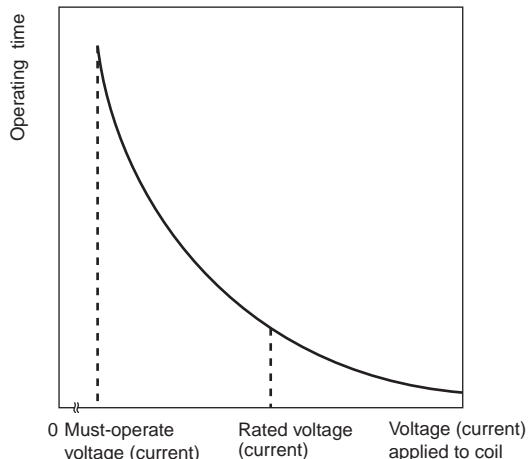

### Relationship between Coil Temperature and Operating Time

When the relay temperature changes, the springiness of the relay contact spring, the amount of friction, and the coil resistance change. Of these, the coil resistance has the largest impact on the operating time. As explained in the section on the principles of operation, the movement of the electromagnet is related to the current. The current of DC electromagnets can be expressed by the following equation.

$$i = \frac{E}{R} \left( 1 - e^{-\frac{t}{\tau}} \right)$$

$i$  : Coil current

$R$  : Coil resistance

$E$  : Voltage applied to coil

$\tau$  : L/R coil time constant

$t$  : Time elapsed from when voltage was applied to coil

At this point, if the coil temperature rises and the coil resistance increases by 0.4% per °C as stated before. This increases  $R$  (the DC coil resistance) of the coil time constant (L/R), therefore reducing the waiting time of the contacts and shortening the operating time. On the other hand, if the coil resistance increases, the coil current decreases. This extends the operating time of the DC relay.

The figure shows the change in operating time according to coil temperature for voltage and current operation.

Large relays that have an operating time of a few 10 ms do not change a lot even if the temperature changes. Small relays that have an operating time of less than 10 ms tend to change more when the temperature changes.

### Relationship between Coil Temperature and Operating Time

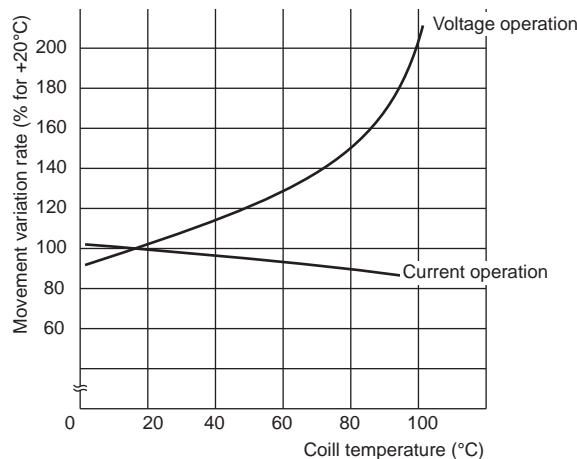

## Operating Environment

### Silver Migration

Silver migration occurs when certain humidity and oxidation-reduction conditions exist and an DC voltage is applied to silver electrodes for an extended period of time.

This phenomenon causes the insulation to deteriorate and occasionally causes short-circuit problems.

#### Silver Migration

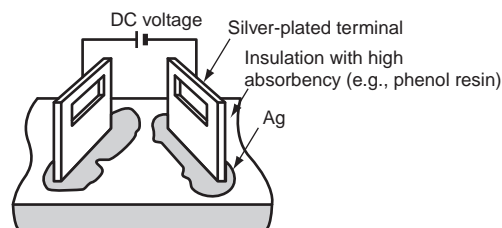

Enlarged Photograph of Silver Migration

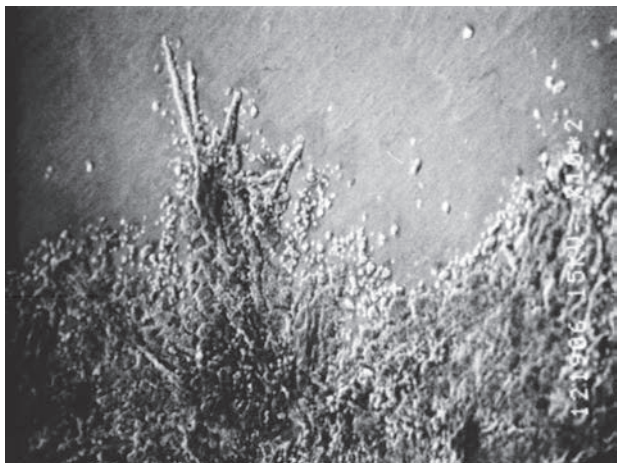

It is not well known what causes silver migration or what conditions accelerate silver migration. However, the following points can be made.

Conditions that Cause Silver Migration	Conditions that Accelerate Silver Migration
Usage of silver	<ul style="list-style-type: none"> <li>Applied voltage is high and insulation is thin (high potential gradient).</li> <li>High water absorption rate of insulation material</li> <li>Oxidation-reduction gases such as (SO<sub>2</sub>, H<sub>2</sub>S, NH<sub>3</sub>)</li> </ul>
Applying DC voltage for an extended period of time	
Insulation with high absorbency of humidity	
Usage in high-temperature or high-humidity environments	

General-purpose relays made by OMRON do not use silver-plated terminals and silver migration will not occur in them.

### Cat Whiskers

When a plated part is stored for an extended period of time, needlelike crystals form on the surface. These crystals are called cat whiskers because of their shape. Depending on the length of the crystals, they may cause short-circuit problems.

The reason why cat whiskers are formed is not completely understood. However, it is said that they will form easily when brass or zinc is used as the base material and tin or zinc is used for the plating material.

Example of Whisker Formation



General-purpose relays made by OMRON have hot dip plating or special zinc plating to guard against the formation of whiskers. When designing parts, print boards, or patterns, keep in mind about the use of zinc and brass, and allocate enough space for the insulation.

### High-humidity Relays

When shipping relays through tropical zones, regardless whether it is just the relays or the relays are built in to other devices, they will be exposed to high temperatures and high humidity.

To protect the metallic materials from this kind of environment, high-humidity relays with special external specifications have been developed.

### Contact Deterioration Due to the Environment

Even if relays are not used and just stored, the degradation of the contacts may progress.

This is due to the influences of sulfur and chlorine contained in the atmosphere, as shown in the following table.

If a relay is to be stored for such a long period as years, it is recommended to perform a conductivity test when the Relay is actually used, or to use Relays with gold-plated or gold-clad contacts.

Area	Detected elements	Results of observation of contact surfaces (Ag contacts left for 12 months)
Chemical plant	Ag and S	Almost uniform and dense corrosive substances were observed on the entire surface of the contacts. As a result of analysis, Ag <sub>2</sub> S was detected.
Steel mill	Ag and S	Irregular projections and recesses were observed and pillars of crystals were dispersed. As a result of analysis, Ag <sub>2</sub> S was detected .
Highway	Ag, S, and CL	Circular crystals were sporadically observed. Ag <sub>2</sub> S was extremely thin at the white portions, approx. 20 Å.

### Chemical Plant

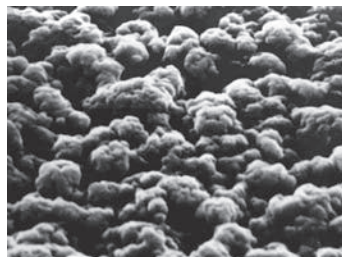

×5,000

### Steel Mill

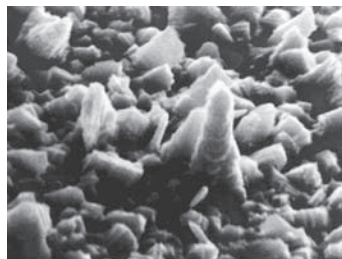

×5,000

### Highway

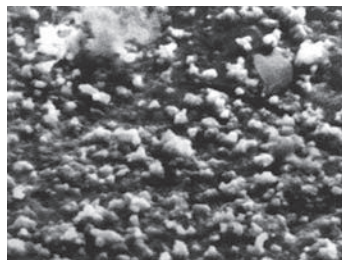

×5,000

Sensors  
Switches  
Safety Components  
Relays  
Control Components  
Automation Systems  
Motion / Drives  
Energy Conservation Support / Environment Measure Equipment  
Power Supplies / In Addition  
Others  
Common

## Contacts

### Inherent Characteristics of Contacts

The desirable features of contacts, purely from a usage point of view, are that they have stable characteristics (such as contact resistance) and that they have a long life. To meet these conditions, contact follow and contact pressure are important aspects.

The contact pressure is normally 5 to 50 g for general-use silver and platinum, and 3 to 10 g for precious metals such as gold, silver, and palladium. The pressure is smaller for precious metals because the switching capacity is smaller and they are relatively robust against environmental influences.

Contact follow requires the contacts to be touching even if the contacts are somewhat worn out. It is closely related to the contact pressure. The product of the two is the workload of the contacts. For a certain workload, the contact pressure can be increased or the contact follow can be increased to change the contactability.

For example, when the contact pressure is large and the contact follow is small, initially characteristics will appear stable, but as the contact begins to wear out, the contact pressure will rapidly drop and eventually the contacts will not touch at all.

On the other hand, if the contact pressure is small and the contact follow is large, the contact resistance may increase, or it may be difficult to break down the film. Therefore, good relays must have a reasonable balance between contact follow and contact pressure. Contact resistance can be thought of as the concentrated resistance and boundary resistance.

At first glance, the contacts look like they are touching the whole surface. However, depending on the shape and the roughness of the surface of the contacts, they actually touch only on a single or multiple points. Current flow is concentrated at these contact points and the generated resistance is the concentrated resistance.

The contact resistance is related to the contact stiffness, contact pressure, and the inherent resistance of contact material. A model of the contacting parts is shown below. Contact is made over an extremely small area, and current is concentrated in this extremely small area.

A measurement example of the relationship between contact pressure and contact resistance is also shown below.

Current Distribution at Connection Point

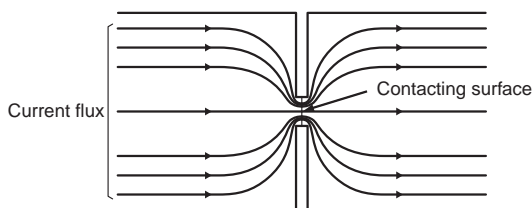

Contact Pressure and Contact Resistance

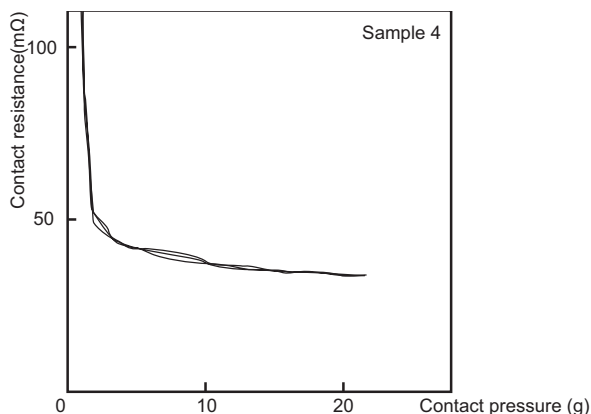

If contacts are exposed to the air, the formation of oxidation and sulphurization films is unavoidable. The resistance caused by these films is called the boundary resistance (film resistance).

Generally, the concentrated resistance makes up a large proportion of the contact resistance before the contacts are used. However, as the contacts are used, arcing and mechanical friction begin to wear them out, and the proportion of the boundary resistance increases.

The proportion depends on the switching frequency. Contact surfaces subject to higher switching frequencies are relatively clean and the boundary resistance is low. Contacts with low switching frequencies generate films with fairly high boundary resistance.

The contact resistance of a relay is listed in catalogs but it is only a provision of the initial value determined using a standard testing method. The actual contact resistance must be suitable for the application device. Normally it is determined by the tolerance to load impedance. Except for special cases, such as the transmission of sound currents where distortion and attenuation becomes problems, the contact resistance has a tolerance of 1% to 5% of the load impedance.

### Load Conditions and Contacts

Most of the problems that occur to a relay are caused by the contactability of the contacts. Load conditions also influence the types of problems that occur.

Load conditions can be grouped into micro-energy level (dry circuit), mid-energy level, and high-energy level conditions.

The micro-energy level in a strict sense is a load condition of a mechanical contact circuit, where the status of the contacts is not affected by heat or discharge. In reality, however, the status of the contacts does not change even when a reasonable voltage is applied, so this load condition is included in the definition.

The voltage level at which the status of the contacts remains unaffected is called the softening voltage. It is 0.09 V for silver, 0.08 V for gold, 0.25 V for platinum, and 0.6 V for tungsten.

The mid-energy level is a load condition where there is a mild discharge effect. It is from the softening voltage to where arc discharge begins. Flashover begins at 12 V for silver, 15 V for gold, 17.5 V for platinum, 15 V for tungsten, and 11 V for 10% palladium silver alloy.

The high-energy level describes voltages that exceed the arc discharge voltage.

Sensors

Switches

Safety Components

Relays

Control Components

Automation Systems

Motion / Drives

Energy Conservation Support / Environment Measure Equipment

Power Supplies / In Addition

Others

Common

## Problems Specific to Contacts

Particular problems can occur depending on how contacts are used. The following describes some of them.

### (1) Abnormal Corrosion from Load Switching

This problem occurs when arcing due to load switching bonds nitrogen and oxygen in the atmosphere together to form  $\text{HNO}_3$ , which corrodes metallic materials. (This is called nitric acid corrosion.)

#### Example of Nitric Acid Corrosion

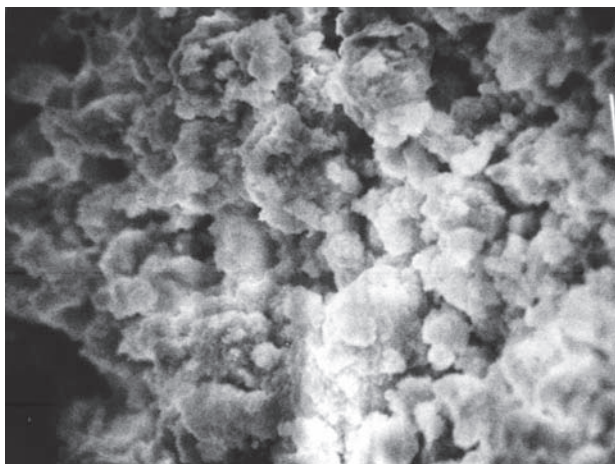

The following countermeasures may be effective.

1. Reduce the amount of arcing that occurs during load switching by creating an arc reduction circuit.
2. Reduce the switching frequency to eliminate continual arcing.
3. Reduce the humidity in the atmosphere.

### (2) Coherer Effect

If there is a film on the surface of a contact and the contacts are touching, the film electrically breaks down and the contact resistance drops rapidly when the contact voltage exceeds a certain value.

### (3) Thermoelectromotive Force

Relay contacts are made from a combination of metals (such as silver and copper alloy), depending on their function. The temperature varies between the junctions depending on the distance from the heat-emitting body (such as the coil) and depending on the path of heat conduction. As a result, thermoelectromotive force from a few to a few tens of  $\mu\text{V}$  is created between the contact terminals. Care must be taken especially when handling micro signals.

A latching relay (keep relay) can be used to shorten the time required for current to pass through the coil, thus limiting the amount of heat generated by the coil and reducing the thermoelectromotive force. A relay with small thermoelectromotive force can also be used. (These relay have a specially designed contact conduction section.)

### Contactability under Load Conditions

The effect on the contacts is completely different between the micro-energy level and high-energy level load conditions. The micro-energy level has little contact wear, but the existence of contact faults becomes a problem. Contact wear, welding, and transfer become problems in the high-energy level load condition.

At the micro-energy level, the cleanliness of the contacts is the most important aspect. If any non-conductive material or film is stuck to the contacts, it will cause contact failure.

Non-conductive materials may be dust, such as sand and fibers, but micro-load relays have relatively small contact wipes and pressure so any particles stuck to the contact surfaces will cause contact faults. This is a problem for all

relays regardless of the contact material, which makes it difficult to select and use the right relay. Formation of a non-conductive film may be caused by the type of material the relay is made from, or the surrounding environment. The film depends on the moisture in the air, oily or oxidized substances, organic gases emitted from other relays or structures, exhaust gas from vehicles, smoke from factories, flux from soldering, and fingerprints of the assembly worker. Therefore, strategies are required for the structure of the relay, the material of the contacts, and ambient conditions.

Generic silver contacts oxidize and sulphurize easily. Oxidized films do not affect the contacts a lot, but sulphurization films have a large effect. For this reason, precious metals that do not sulphurize easily are used. Normally, palladium, gold, or platinum-gold is combined with silver to form silver alloys to use for the contacts. Contacts made from platinum alloys generate insulating powder (brown powder) due to the unsaturated organic gas that is emitted from benzene, gasoline, and similar substances. Gold does not form any films and the contactability remains stable, but it is soft, so it bends under low pressure. It cannot be used by itself, so palladium may be used to create a double-layer contact where the top layer is a gold film.

In conditions where discharge occurs even with only micro-loads, the contacts may oxidize or combustible gases in the atmosphere may burn and create a carbonized film. Carbonized films are not perfect insulators, so the resistance may reach a few ten to a few hundred ohms.

At the high-energy level, flashover continuously generates a lot of energy. This may cause the contacts to melt when they are switching, or the contacts to wear out from scattering of metallic vapor. They may also suffer from problems such as transfer of metallic powder from one contact to the other, or welding where the contacts melt and bond together when power is supplied.

DC voltages and DC currents do not have points that cross at zero like there is for an AC voltage and current. So even for fairly small loads, arcing may continue for a long time.

Under these load conditions, adherence of metallic powder and carbonizing of the insulator may deteriorate the insulation. For this reason, certain types of insulation materials and shapes are chosen. The type of damage that occurs to the contacts depends on the type of load.

Loads such as transformers, motors, and lamps cause large inrush currents and can cause welding of the contacts. Lamps, motors, transformers, and solenoids cause currents of a few times to multiples of ten times the current.

Inductive loads, such as motors, transformers, and solenoids, cause large reverse currents when power is turned OFF. The voltages reach 4 to 20 times the normal voltage. This may wear out the contacts or damage the load.

#### Waveform of Induction Motor Starting Current



#### Waveform of AC Solenoid Starting Current



#### Waveform of Lamp Starting Current



# Troubleshooting

## Failure Examples

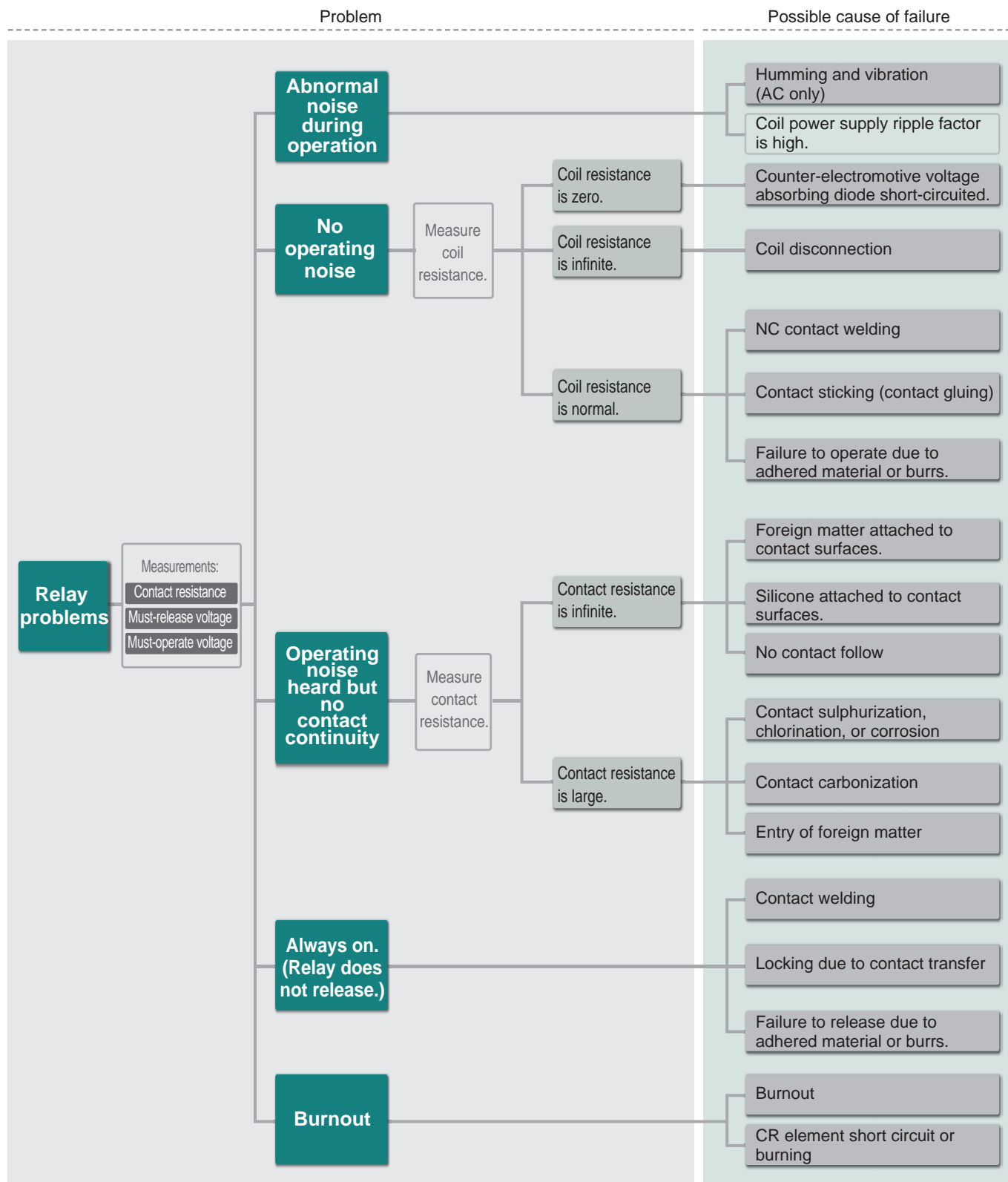

**Note:** You may perform troubleshooting, but do not open the case.

Sensors

Switches

Safety Components

Relays

Control Components

Automation Systems

Motion / Drives

Energy Conservation Support / Environment Measure Equipment

Power Supplies / In Addition

Others

Common



## Failures and Assessing Causes

Various problems can occur with relays in devices that use relays.

An analysis, such as a fault tree analysis (FTA), is useful for assessing the cause of the problem.

The following table lists relay failure modes and suggests possible causes.

### Problems Visible from Outside the Relay

Failure	Item to check	Possible cause
Relay does not operate.	1. Is the input voltage reaching the relay?	<ul style="list-style-type: none"> <li>The breaker or fuse may have been activated.</li> <li>The wiring may be incorrect or there may be a leakage.</li> <li>The screw terminals have not been tightened sufficiently.</li> </ul>
	2. Is a relay with specifications suitable for the input voltage being used?	<ul style="list-style-type: none"> <li>Use 200 VAC relays for 100 VAC voltage lines.</li> </ul>
	3. Is there voltage drop in the input voltage?	<ul style="list-style-type: none"> <li>The supply power has insufficient capacity.</li> <li>The wiring covers a long distance.</li> </ul>
	4. Is the relay damaged?	<ul style="list-style-type: none"> <li>The coil is disconnected.</li> <li>There is mechanical damage from being dropped or exposed to shock.</li> </ul>
	5. Is there an error in the output circuit?	<ul style="list-style-type: none"> <li>Output side power supply</li> <li>Load failure</li> <li>Incorrect wiring</li> <li>Faulty connection</li> </ul>
	6. Is there a faulty contact?	<ul style="list-style-type: none"> <li>Contact error</li> <li>Contact deterioration due to end of service life</li> <li>Mechanical damage</li> </ul>
The relay does not release.	1. Is the applied voltage completely cut off?	<ul style="list-style-type: none"> <li>Leakage current in the protective circuit (surge absorber)</li> <li>Voltage applied by bypass circuit</li> <li>Semiconductor control circuit with residual voltage</li> </ul>
	2. Relay error	<ul style="list-style-type: none"> <li>Contact weld</li> <li>Insulation deterioration</li> <li>Mechanical damage</li> <li>Inductive voltage (long-distance wiring)</li> </ul>
The relay malfunctions. The indicator lights incorrectly.	1. Is incorrect voltage being applied to the relay input terminals?	<ul style="list-style-type: none"> <li>Inductive voltage (long-distance wiring)</li> <li>Bypass circuit from inductive voltage (A latching relay not holding.)</li> </ul>
	2. Is excessive vibration or shock being applied?	<ul style="list-style-type: none"> <li>Unsuitable operating conditions</li> </ul>
Burnout	1. Is there burnout from the coil?	<ul style="list-style-type: none"> <li>Incorrect coil specifications selected.</li> <li>Applied voltage exceeds rating.</li> <li>Imperfect operation of electromagnet with AC specifications (insufficient armature connection)</li> </ul>
	2. Is there burning from the contact?	<ul style="list-style-type: none"> <li>Current exceeds rating for contacts.</li> <li>Allowable inrush current exceeded.</li> <li>Short-circuit current</li> <li>Imperfect external connection (heat generated by imperfect contact with socket)</li> </ul>

### Problems Visible from Inside the Relay

Failure	Item to check	Possible cause
Contact welding	1. Was there a large current flow?	<ul style="list-style-type: none"> <li>A rush current, e.g., from a lamp load</li> <li>Load short-circuited current</li> </ul>
	2. Has there been abnormal vibration in the contacting section?	<ul style="list-style-type: none"> <li>External vibration or shock</li> <li>AC relay humming</li> <li>Contact chattering from imperfect operation caused by voltage drop (Voltage drop sometimes occurs instantaneously when the motor is operated.)</li> </ul>
	3. Is switching occurring too frequently?	—
	4. Has the relay reached the end of its service life?	—
Faulty contacts	1. Is there foreign matter on the contact surfaces?	<ul style="list-style-type: none"> <li>Silicone, carbon, or other foreign matter</li> </ul>
	2. Is the contact surface corroded?	<ul style="list-style-type: none"> <li>Contact sulphurization from SO<sub>2</sub> and H<sub>2</sub>S</li> </ul>
	3. Is there a mechanical cause?	<ul style="list-style-type: none"> <li>Terminal displacement, contact displacement, or contact follow</li> </ul>
	4. Have the contacts deteriorated?	<ul style="list-style-type: none"> <li>End of relay service life</li> </ul>
Humming	1. Is the applied voltage sufficient?	<ul style="list-style-type: none"> <li>Incorrect relay coil specifications</li> <li>Applied voltage ripple</li> <li>Slow rise in input voltage</li> </ul>
	2. Has the correct relay type been chosen?	<ul style="list-style-type: none"> <li>DC specifications used for AC lines</li> </ul>
	3. Is the electromagnet operating correctly?	<ul style="list-style-type: none"> <li>Foreign matter between the moving armature and core</li> </ul>
Abnormal deterioration of contacts	1. Has the correct relay been selected?	<ul style="list-style-type: none"> <li>Incorrect selection of voltage, current, or inrush current ratings</li> </ul>
	2. Has enough consideration been given to the connected load?	<ul style="list-style-type: none"> <li>Inrush current from a motor load, solenoid load, lamp load, etc.</li> </ul>

## Approach to Maintenance

There are two main types of maintenance: corrective maintenance, i.e., inspections and replacements that take place after a failure has occurred, and preventative maintenance, i.e., inspections and maintenance that is undertaken before failure occurs.

One of the important issues with preventative maintenance is when to perform inspections and replacements, how to know when that is required, and how to determine the timing.

The factors that must be considered when determining maintenance schedules for relays is the target device and its level of importance and the required reliability level, when looking at maintenance from the device or system perspective. There are also different types of failure for the different characteristics and items based on the type of relay.

Relay failure types can be broadly classified into failures from wear, typified by worn out contacts, and deterioration failures, such as layer shorts in coil windings.

In general, once the conditions of use for the relay being used have been determined, it is possible to predict maintenance requirements because types of wear, such as contact wear, and the timing of wear-related failures is aligned to the number of operations. On the other hand, deterioration failures, such as layer shorts in coil windings, are greatly affected by the inherent reliability of the relay being used. The maintenance requirements are affected by use reliability, e.g., operating conditions and on-site environment. This means that the failures are often different for each case, which makes it difficult to determine a maintenance schedule beforehand.

In actual operation, wear and deterioration progress at the same time and it is important to know which type of failure is going to occur first when determining maintenance schedules.

The following items are useful for reference when determining maintenance timing.

		Maintenance Timing	Determined by No. of operations	Determined by time	Remarks
Wear	Contact wear	The maintenance timing can be determined from the electrical durability curve drawn from load voltage, current, and load type. If there is no applicable electrical durability curve, the maintenance timing can be determined from test values from the device.	○	-	If the number of switching operation per unit time can be determined, the number of operations can be replaced by the time.
	Wear in operating mechanisms	The maintenance timing can be determined from number of operations in the mechanical durability of the relay. If the mechanical durability listed in the performance specifications is a value determined under standard test conditions and the actual operating conditions differ from these standard test conditions, the maintenance timing should be determined based on test values from actual operating conditions.		-	
Deterioration	Insulation Deterioration of Coils and Coil Windings	The life of a coil can be predicted if the temperature in the conditions that the coil is operated under is known. A total of 40,000 hours at 120°C is used as a reference point for most polyurethane copper wire coils.	-	○	-
	Contacting Stability of Contacts	Inherent reliability is changed dramatically by operating conditions and the environment. Maintenance timing can be determined by understanding the operating conditions and environment and performing sampling.	-	○	It is important to understand toxic gas concentrations that adversely affect the on-site environment and contact material.
	Deterioration of performance of metallic material				
	Deterioration of performance of resin material				

## Maintenance Guidelines

### Mechanical Durability

The external appearance and change in performance are monitored with a rated voltage (or rated frequency for AC operation) applied to a coil when the contact is under no load and is switched at the rated frequency.

### Electrical Durability

The external appearance and change in performance are monitored with a rated load connected to the contact and the rated voltage (or rated frequency for AC operation) applied to the coil.

Whether or not the electrical durability has been reached depends on the type of usage.

#### Guide to Determining the Durability

<b>Evaluated item</b>	Specified value		
<b>External appearance</b>	No looseness, deformation, or damage		
<b>Insulation resistance</b>	1 MΩ min. if not specified		
<b>Dielectric strength</b>	75% min. of initial specified value		
<b>Coil resistance</b>	95% of initial specified lower limit to 105% of initial specified upper limit		
<b>Must-operate voltage</b>	1.2 times max. of initial specified value		
<b>Must-release voltage</b>	0.5 times max. of initial specified value		
<b>Operating time</b>	1.2 times max. of initial specified value		
<b>Release time</b>	2 times max. of initial specified value		
<b>Contact resistance</b>	Contact rated current or switching current (A)	Measured current (A)	Resistance after contact resistance test (Ω)
	Less than 0.01	0.001	100
	0.01 min. to less than 0.1	0.01	20
	0.1 min. to less than 1	0.1	5
	1 min.	1	2

Based on the NECA C5442. (NECA: Nippon Electric Control Equipment Industries Association)